

Distribution Annual Planning Report 2022



Version Control

Version	Date	Description
1.0	21/12/2022	Final
1.1	4/09/2023	New Website Links

Disclaimer

Energex Distribution Annual Planning Report is prepared and made available solely for information purposes. While care was taken in the preparation of the information in this report, and it is provided in good faith, Energex accepts no responsibility or liability (including without limitation, liability to any person by reason of negligence or negligent mis-statement) for any loss or damage that may be incurred by any person acting in reliance on this information or assumptions drawn from it, except to the extent that liability under any applicable Queensland or Commonwealth of Australia statute cannot be excluded.

It contains assumptions regarding, among other things, economic growth and load forecasts which may or may not prove to be correct. The forecasts included in the document involve analysis which are subject to significant uncertainties and contingencies, many of which are out of the control of Energex. Energex makes no representation or warranty as to the accuracy, reliability, completeness or suitability for any particular purpose of the information in this document. All information should be independently investigated, reviewed, analysed and verified, and must not be relied upon in connection with any investment proposal or decision. The information contained in this report is subject to annual review. Energex is obligated to publish future editions by 31st December, in accordance with the National Electricity Rules.

All financials presented in this document are correct at the time of writing and represent the existing organisational accounting treatment, which may be subject to change. Forecasted data is subject to ongoing variations. Energy Queensland is finalising the alignment of its Cost Allocation Methodology between Ergon and Energex, potentially impacting the treatment of some Capital and Operational Project costs.

Contact Information

Further information on Energex's network management is available on our website:

<https://www.energex.com.au/our-network>

GPO Box 1461 Brisbane QLD 4001
26 Reddacliff Street Newstead QLD 4006
Telephone 13 12 53
www.energex.com.au

Energex Limited ABN 40 078 849 055

© Energex Limited

® Energex and Energex Positive Energy are registered trademarks of Energex Limited ABN 40 078 849 055

This work is copyright. Material contained in this document may be reproduced for personal, in-house or non-commercial use, without formal permission or charge, provided there is due acknowledgement of Energex Limited as the source. Requests and enquiries concerning reproduction and rights for a purpose other than personal, in-house or non-commercial use, should be addressed to the Manager Customer Advocacy, Energex, GPO Box 1461 Brisbane QLD 4001.

Contents

Executive Summary	1
1 Introduction	4
1.1 Foreword.....	4
1.2 Network Overview.....	4
1.3 Peak Demand	6
1.4 Minimum Demand	6
1.5 Changes from Previous Year's DAPR	7
1.6 DAPR Enquiries	8
2 Corporate Profile	10
2.1 Corporate Overview.....	10
2.1.1 Vision, Purpose and Values	10
2.2 Electricity Distribution Network	11
2.3 Network Operating Environment.....	14
2.3.1 Physical Environment	14
2.3.2 Shareholder and Government Expectations	14
2.3.3 Community Safety	14
2.3.4 EQL Health, Safety and Environment Management System	15
2.3.5 Environmental Commitments.....	16
2.3.6 Legislative Compliance.....	16
2.3.7 Economic Regulatory Environment.....	17
2.4 Asset Management Overview	18
2.4.1 Best Practice Asset Management	18
2.4.2 Asset Management Policy	18
2.4.3 Strategic Asset Management Plan.....	18
2.4.4 Investment Process.....	19
2.4.5 Network Risk Management and Program Optimisation	21
2.4.6 Further Information	21
3 Community and Customer Engagement	23
3.1 Overview	23
3.2 Our Engagement Program	24
3.2.1 Customer and Community Council and Other Forums	24
3.2.2 Working with Industry Partners	24
3.2.3 Community Leader Engagement	24
3.2.4 Online Engagement.....	25

3.2.5	Our Customer Research Program	25
3.3	What We Have Heard	26
3.3.1	Safety First	26
3.3.2	More Affordable Electricity	27
3.3.3	A Secure Supply – Keeping the Lights On	28
3.3.4	A Sustainable Future	30
3.4	Our Customer Commitments	32
4	Network Forecasting	34
4.1	Forecast Assumptions	34
4.1.1	Economic Growth	34
4.1.2	Solar PV	35
4.1.3	Electric Vehicles and Energy (battery) Storage	36
4.1.4	Temperature Sensitive Load	37
4.2	Substation and Feeder Maximum Demand Forecasts	37
4.2.1	Zone Substation Forecasting Methodology	38
4.2.2	Sub-transmission 110kV and 132kV Feeder Forecasting Methodology ..	40
4.2.3	Sub-transmission 33kV Feeder Forecasting Methodology	41
4.2.4	Distribution 11kV Feeder Forecasting Methodology	41
4.3	System Maximum Demand Forecast	43
4.3.1	System Demand Forecast Methodology	43
4.3.2	Medium, high and low case scenarios	44
5	Network Planning Framework.....	49
5.1	Background	49
5.2	Planning Methodology	50
5.2.1	Strategic Planning	50
5.2.2	Detailed Planning Studies	51
5.3	Key Drivers for Augmentation.....	52
5.4	Network Planning Criteria.....	53
5.4.1	Value of Customer Reliability	54
5.4.2	Safety Net	55
5.4.3	Risk Quantification and CECV	57
5.4.4	Distribution Networks Planning Criteria	58
5.5	Plant Thermal Ratings	59
5.6	Voltage Limits	61
5.6.1	Voltage Levels.....	61
5.6.2	Sub-transmission Network Voltage	62
5.6.3	11kV Distribution Network.....	62
5.6.4	Low Voltage Network	63
5.7	Fault Level	64

5.7.1	Fault Level Analysis Methodology Assumptions	65
5.8	Planning of Customer Connections	66
5.9	Major Customer Connections, including Embedded Generators	67
5.10	Joint Planning	67
5.10.1	Joint Planning Methodology	67
5.10.2	Joint Planning and Joint Implementation Register	68
5.10.3	Joint Planning with Powerlink	68
5.10.4	Joint Planning with other DNSP	68
5.10.5	Further Information on Joint Planning	69
5.11	Network Planning – Assessing System Limitations	69
5.11.1	Overview of Methodology to Assess Limitations	69
5.11.2	Bulk and Zone Substation Analysis Methodology Assumptions	70
5.11.3	Sub-transmission Feeder Analysis Methodology Assumptions	71
5.11.4	Distribution Feeder Analysis Methodology Assumptions	71
6	Overview of Network Limitations and Recommended Solutions	73
6.1	Network Limitations – Adequacy, Security and Asset Condition	73
6.1.1	Bulk and Zone Substation Capacity Limitations	73
6.1.2	Sub-transmission and Distribution Feeder Capacity Limitations	73
6.1.3	Asset Condition Limitations	73
6.1.4	Fault Level Limitations	73
6.2	11kV Primary Overcurrent and Backup Protection Reach Limits	74
6.3	Summary of Emerging Network Limitations	75
6.4	Regulatory Investment Test for Distribution (RIT-D) Projects	75
6.4.1	Regulatory Investment Test Projects – In Progress	75
6.4.2	Foreseeable RIT-D Projects	76
6.4.3	Urgent or Unforeseen Projects	76
6.5	Emerging Network Limitations Maps	76
7	Demand Management Activities	78
7.1	What is Demand Management	78
7.2	How Demand Management integrates into the Planning Process	80
7.3	Energex’s Demand Side Engagement Strategy	82
7.4	What has the Energex DM Program delivered over the last year?	82
7.4.1	Broad based Demand Management	82
7.4.2	Targeted Demand Management	83
7.4.3	Demand Management Development	83
7.4.4	Demand Management Innovation	83
7.5	Energex DM Program delivery over the next year	84
7.6	Key Issues Arising from Embedded Generation Applications	84
7.6.1	Connection Enquiries Received	85

	7.6.2	Applications to Connect Received	85
	7.6.3	Average Time to Complete Connection	86
8		Asset Life-Cycle Management	88
	8.1	Approach	88
	8.2	Preventative Works	89
	8.2.1	Asset Inspections and Condition Based Maintenance	89
	8.2.2	Asset Condition Management	90
	8.3	Line Assets and Distribution Equipment	92
	8.3.1	Pole and Tower Refurbishment and Replacement	92
	8.3.2	Pole Top Structure Replacement	92
	8.3.3	Overhead Conductor Replacement	92
	8.3.4	Underground Cable Replacement	93
	8.3.5	Customer Service Line Replacement	94
	8.3.6	Distribution Transformer Replacement	94
	8.3.7	Distribution Switches (including RMUs) Replacement	95
	8.4	Substation Primary Plant	95
	8.4.1	Power Transformer Replacement and Refurbishment	95
	8.4.2	Circuit Breaker, and Switchboard Replacement and Refurbishment	95
	8.4.3	Instrument Transformer Replacement and Refurbishment	96
	8.5	Substation Secondary Systems	96
	8.5.1	Protection Relay Replacement Program	96
	8.5.2	Substation DC Supply Systems	97
	8.6	Other Programs	97
	8.6.1	Vegetation Management	97
	8.6.2	Overhead Network Clearance	97
	8.7	Derating	98
9		Network Reliability	100
	9.1	Reliability Measures and Standards	100
	9.1.1	Minimum Service Standard (MSS)	100
	9.1.2	Reliability Performance in 2021-22	101
	9.1.3	Reliability Compliance Process	103
	9.1.4	Reliability Corrective Actions	103
	9.2	Service Target Performance Incentive Scheme (STPIS)	103
	9.2.1	STPIS Results	104
	9.3	High Impact Weather Events	108
	9.3.1	Summer Preparedness	108
	9.3.2	Bushfire Management	109
	9.3.3	Flood Resilience	110
	9.4	Guaranteed Service Levels (GSL)	112

	9.4.1	Automated GSL Payment	112
	9.5	Worst Performing Distribution Feeders	113
	9.5.1	Details of worst performing distribution feeders reported from 2021-22	114
	9.5.2	Review of Worst Performing Distribution Feeders from 2020-21	114
	9.5.3	Worst Performing Feeder Improvement Program	115
	9.6	Safety Net Target Performance	115
	9.7	Emergency Frequency Control Schemes and Protection Systems	116
10		Power Quality.....	118
	10.1	Quality of Supply Processes	118
	10.2	Customer Experience	119
	10.3	Power Quality Supply Standards, Codes Standards and Guidelines	121
	10.4	Power Quality Performance 2021-22	123
	10.4.1	Power Quality Performance Monitoring	123
	10.4.2	Steady State Voltage Regulation - Overvoltage	124
	10.4.3	Steady State Voltage Regulation – Under Voltage.....	125
	10.4.4	Voltage Unbalance	125
	10.4.5	Harmonic Distortion	126
	10.5	Power Quality Ongoing Challenges and Corrective Actions	127
	10.5.1	Low Voltage Networks	127
	10.5.2	Planned actions for 2020-25 Regulatory Period.....	128
11		Network Challenges and Opportunities	130
	11.1	Solar PV	130
	11.1.1	Solar PV Issues and Statistics	130
	11.1.2	Impacts of Solar PV on Load Profiles	131
	11.1.3	Solar PV remediation options	136
	11.2	Strategic Response	136
	11.2.1	Roadmap to an Intelligent Grid	136
	11.3	Electric Vehicles	137
	11.4	Battery Energy Storage Systems	138
	11.5	Land and Easement Acquisition Timeframes	138
	11.6	Impact of Climate Change on the Network	139
	11.7	Minimum System Load – Emergency Backstop Mechanism	139
12		Information Technology and Communication Systems.....	142
	12.1	Information Communication and Technology	142
	12.1.1	Information Communication and Technology Investments 2021-22	142
	12.2	Forward ICT Program	145
	12.3	Metering	146
	12.3.1	Revenue Metering Investments in 2021-2022	146
	12.3.2	Revenue Metering Investments from 2022-23 to 2026-27	146

12.4	Operational and Future Technology	147
12.4.1	Telecommunications	147
12.4.2	Operational Systems	148
12.4.3	Investments in 2021-22	151
12.4.4	Planned Investments for 2022-23 to 2026-27	152
Appendix A Terms and Definitions		A2
Appendix B NER and DA Cross Reference		B2
Appendix C Network Limitations and Mitigation Strategies		C2
Appendix D Substations Forecast and Capacity Tables		D2
D.1	Supporting Notes	D2
D.2	Peak Load Forecast and Capacity Tables	D3
D.2.1	Calculation of Load at Risk	D6
D.2.2	Network Security Standards	D7
Appendix E Feeders Forecast and Capacity Tables		E2
E.1	Supporting Notes on Feeders	E2
E.2	Peak Load Forecast and Capacity Tables	E2
E.2.1	Distribution (11kV) Feeder Studies	E3
E.2.2	Network Security Standards	E6
E.2.3	Available Transfers	E6
Appendix F Worst Performing Distribution Feeders		F2

Table of Figures

Figure 1 – Typical Electricity Supply Chain	5
Figure 2 – Energy Queensland Vision, Purpose and Values	10
Figure 3 – Energex Distribution Hubs	13
Figure 4 – SAMP translates Corporate Objectives to Asset Management Objectives	19
Figure 5 – Program of Work Governance	20
Figure 6 – System Demand – Solar PV Impact, 2 February 2022	36
Figure 7 – Three Scenarios of EGX Summer Peak MW Forecasts @ 50 PoE Level.....	45
Figure 8 – EQL Climate Zones	60
Figure 9 – System Limitations Assessing Process	69
Figure 10 – DM Approaches	79
Figure 11 – Non Network Assessment Process for Expenditure <\$6M	81
Figure 12 – Non Network Assessment Process for Expenditure >\$6M (RIT-D).....	81
Figure 13 – Process to Create Asset Investment Plan	91
Figure 14 – Annual Network SAIDI and SAIFI Performance Five-year Rolling Average Trend	102
Figure 15 – STPIS Targets and Results for Unplanned CBD	105
Figure 16 – STPIS Targets and Results for Unplanned Urban	106
Figure 17 – STPIS Targets and Results for Unplanned Short Rural	107
Figure 18 – Systematic Approach to Voltage Management.....	118
Figure 19 – Quality of Supply Enquiries per 10,000 Customers	119
Figure 20 – Quality of Supply Enquiries by Category 2021-22	120
Figure 21 – Quality of Supply Enquiries per Year	120
Figure 22 – Quality of Supply Enquiries by Cause at Close Out	121
Figure 23 – Number of Monitored Sites Reporting Overvoltage	124
Figure 24 – Number of Monitored Sites Reporting Under Voltage.....	125
Figure 25 – Number of Monitored Sites Reporting Voltage Unbalance	126

Figure 26 – Number of Monitored Sites Reporting Total Harmonic Distortion 127

Figure 27 – Grid Connected solar PV System Capacity by Tariff as at June 2022 131

Figure 28 – Spring Load Profile with increasing Solar PV of North Maclean Zone Substation 132

Figure 29 – Number of customers with Solar PV by Zone Substation 133

Figure 30 – Installed Capacity of Solar PV by Zone Substation 134

Figure 31 – Percentage of Solar PV Penetration by Zone Substation 135

Table of Tables

Table 1 – Summary of Network and Customer Statistics for 2021-22	12
Table 2 – Actual Maximum Demand Growth – South-East Qld	46
Table 3 – Maximum Demand Forecast (MW) – South-East Qld	47
Table 4 – Contribution of Solar PV, EVs and Battery Storage Systems to Summer System Peak Demand	47
Table 5 – Safety Net	56
Table 6 – Service Safety Net Targets	57
Table 7 – Energex Distribution Area Climate Parameters	59
Table 8 – System Operating Voltages	61
Table 9 – Steady State Maximum Voltage Drop	62
Table 10 – Maximum Allowable Voltage	64
Table 11 – Energex Design Fault Level Limits	65
Table 12 – Joint Planning Activities Covering 2022-23 to 2026-27	68
Table 13 – Summary of Substation and Feeder Limitations	74
Table 14 – In Progress RIT-D Projects	75
Table 15 – Potential RIT-D Projects	76
Table 16 – Embedded Generator Enquiries	85
Table 17 – Embedded Generator Applications	85
Table 18 – Embedded Generator Applications – Average Time to Complete	86
Table 19 – Number of Energex Neutral Failures by Financial Years	94
Table 20 – Annual Normalised Reliability Performance Compared to MSS Limits	101
Table 21 – Normalised Reliability Performance Compared to STPIS Targets	104
Table 22 – GSL Limits Applied by Feeder Type	112
Table 23 – GSLs Claims Paid 2021-22	113
Table 24 – 2021-22 Worst Performing Feeder List – Current Performance	114

Table 25 – Allowable Variations from the Relevant Standard Nominal Voltages	122
Table 26 – Allowable Planning Voltage Fluctuation (Flicker) Limits	122
Table 27 – Allowable Planning Voltage Total Harmonic Distortion Limits	123
Table 28 – Allowable Voltage Unbalance Limits	123
Table 29 – Remediation options for increasing penetrations of solar PV	136
Table 30 – ICT Investments 2021-22	142
Table 31 – ICT Investment 2022-23 to 2026-27	145
Table 32 – Operational Technology Investments 2021-22	151
Table 33 – Operational Technology Planned Investments 2022-23 to 2026-27	152
Table D1 – Definition of Terms Peak Load Forecast and Capacity Tables	D4
Table E1 – Definition of Terms Feeder Capacity and Forecast Tables	E4

Executive Summary

Energex's Distribution Annual Planning Report (DAPR) 2022 provides the company's intentions for the next five years in an environment characterised by rapid technological change and continuous high penetrations of renewable energy resources.

The DAPR provides the community and stakeholders with an insight into the key factors shaping our plans, the current and forecasted electricity demand, the state of our networks and service performance trends, as well as our investment intentions for the coming years. Many solutions seek customer and industry participation to resolve. In addition, the online interactive network maps for market proponents indicate locations for potential investments.

To ensure we are meeting the unique and diverse needs of our communities and customers, in a period where the energy sector is undergoing rapid transformation, we coordinate engagement and performance management programs which have shaped our Regulatory Determination for 2020-25, our network tariff reform program and our investment plans.

As Energex's network ages and the risk of equipment failure towards end of life increases, a focus on maintaining safety outcomes for our staff, customers and communities is paramount. We continue to focus on improving safety in our maintenance and replacement practices across all asset categories and continue to invest in trialling new technology that has the potential to deliver safer outcomes, more efficiently for our customers.

While COVID-19 has had varied impacts on the economy, we continued to provide reliable and secure supply to our customers. Energex's network reliability performance results in 2021-22 were favourable against all measures in the Distribution Authority.

The 2021-22 summer peak set a new record high of 5,289MW on 2nd February 2022 between 2.30 and 3.00pm. The peak was created by the hot weather driving up air conditioning load, and widespread afternoon cloud cover reducing the available solar energy generated and increasing the load on grid supplied electricity. It is estimated that solar Photovoltaic (PV) reduced the peak by around 486MW at this time.

The uptake of solar PV in the residential, commercial and industrial sectors has created the need to forecast minimum demand on the Energex network. Historically, Energex's minimum demand has occurred in the late evening/early morning. The recent minimum demand occurred during daytime on 18 September 2022 with a minimum of 399MW.

Cyber security is an area of increasing focus of all utilities and we continue to evolve our approach as a fundamental part of maintaining network and business security. Information and Communications Technology (ICT) programs have been initiated to improve technology to deal with evolving business needs, a distributed workforce, changing ways of working and an increasingly complex cyber security environment.

We continue to transform our networks into an intelligent grid so that our customers can leverage the many benefits of digital transformation, distributed energy resources and emerging technologies, like solar PV, battery storage and Electric Vehicles (EVs), as well as the next generation of home and commercial energy management systems. The uptake rate of EVs is expected to rise due to the number of new car models being released and the increased availability of public charging stations. In parallel,

customer interest for battery storage systems is increasing, and with solar PVs and EVs and other distributed energy resources they will shape our energy and power demand profiles in the future.

Chapter 1

Introduction

- Foreword
- Network Overview
- Peak Demand
- Minimum Demand
- Changes from Previous Year's DAPR
- DAPR Enquiries

1 Introduction

1.1 Foreword

This Distribution Annual Planning Report (DAPR) 2022 explains how Energex is continuing to safely and efficiently manage the electricity distribution network in South East Queensland (SEQ) and also details Energex's intentions for the next five years in relation to: load forecasting, demand management, non-network initiatives, network investments, customer load and renewable connection support, reliability and supply quality in safe, prudent and efficient operation and management of our power network.

The DAPR supports our commitment to open and transparent customer, community and shareholder engagement. It presents the outcomes from our distribution network service provisions carried out in the forward planning period 2022-23 to 2026-27 as a requirement under the National Electricity Rules (NER Rule 5.13 and Schedule 5.8) and in compliance with Queensland's Electricity Distribution Network Code (clause 2.2) and Distribution Authority.

This report captures the results of planning activities including forecasts of emerging network limitations for the purposes of market consultations. Importantly, customer supply risks are assessed through ongoing planning activities, and in conjunction with market participants, appropriate future investments are scheduled to ensure risks are addressed in accordance with obligated service standards.

For readers seeking to learn of planning outcomes since the 2021 DAPR, they are referred to Section 5.10 for joint planning outcomes, to Section 6.4 for upcoming Regulatory Investment Test for Distribution (RIT-D), and to Appendix C for committed projects and proposed opportunities.

Energex understands that as cost of living pressures increase for many South East Queenslanders, prudent investment plans are required in order to maintain required performance targets whilst minimising operating and capital costs. In addition, Energex must continue to ensure the safety of the public and its employees by managing the risks associated with the electricity network.

1.2 Network Overview

Electricity is a commodity that underpins our modern society, providing energy to domestic, commercial, industrial, agricultural and mining sectors, supporting lifestyle and prosperity of individuals as well as our state as a whole. The electricity grid, including transmission and distribution networks, connects and facilitates the distribution of electrical energy between generators and users. The bulk of electricity is generated on demand at locations remote to the point of supply.

Large generators located outside SEQ are connected to Powerlink's transmission network. In turn, Powerlink delivers this electricity to the Energex distribution network in order to distribute electricity to customers. The transmission network supplies bulk electricity to Energex's distribution network, which in turn supplies to Queensland's industries, homes and businesses.

Figure 1 summarises this electricity supply chain to illustrate how electricity is generated, transmitted and distributed to customers. Connection points exist between generators, transmission networks, distribution networks, embedded generators and large customers. Electricity carried over Powerlink's network is delivered in bulk to substations that connect to overhead or underground sub-transmission feeders to supply zone substations. Zone substations connect to overhead or underground distribution feeders operating at 11kV. Distribution feeders distribute electricity to distribution transformers that supply Low Voltage (LV) lines at 400/230 volts for customers. Importantly, customers use the network to obtain electricity upon demand, and to export electricity when excess solar power is generated.

With the increase in Embedded Generation (EG) systems being connected to the network, including small and large scale solar Photovoltaic (PV) and other renewable energy sources, electricity is now being generated and exported into the grid from customers' premises. Depending on the size and number of these systems, power flow in parts of our networks are periodically in reverse, creating both challenges and opportunities for the network.

Figure 1 – Typical Electricity Supply Chain

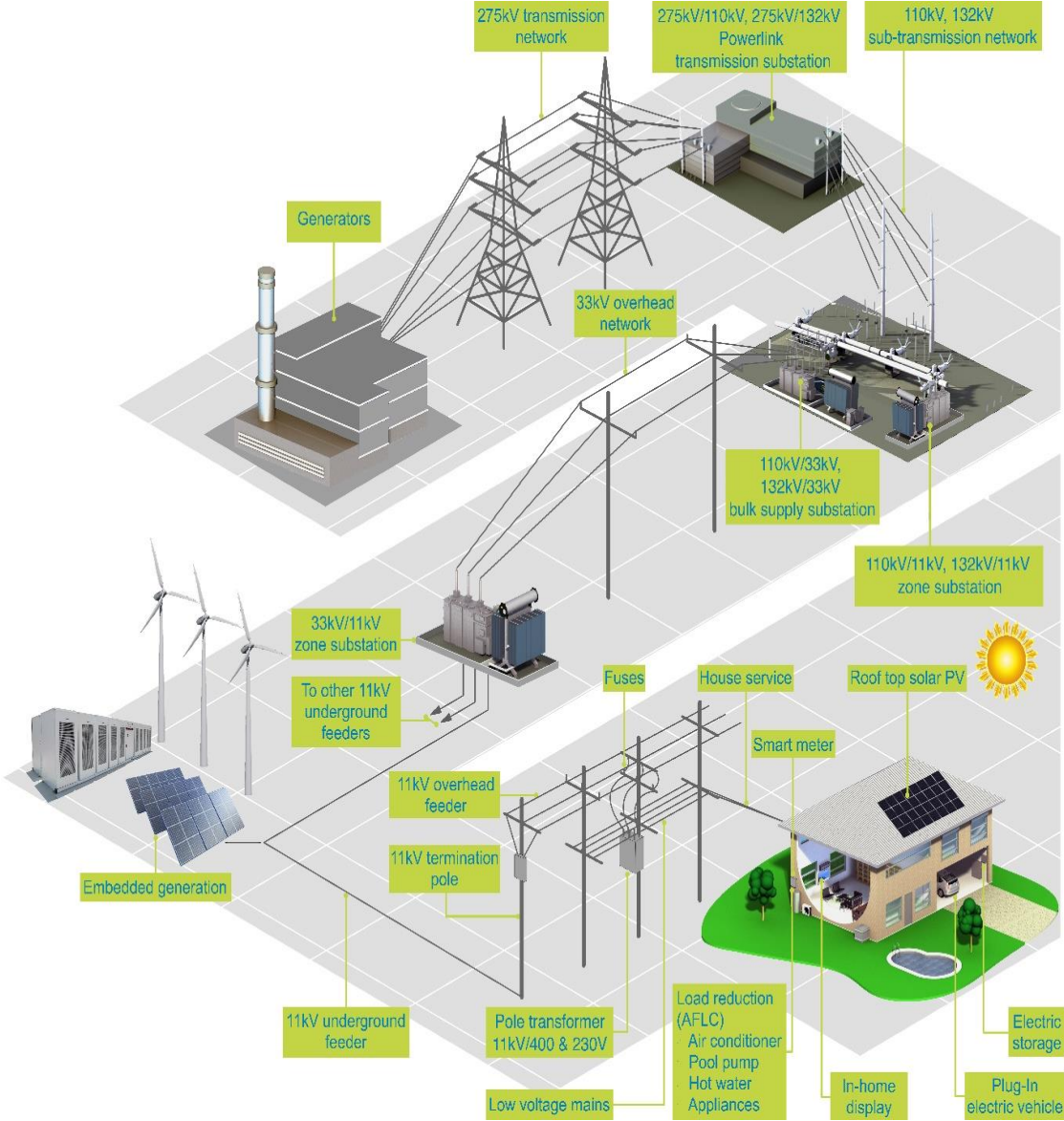

1.3 Peak Demand

The demand for electricity at the point in time when prevailing electricity use is at its highest is known as peak demand. Growth in peak demand is one of the critical factors in the planning, design and operation of the electricity system. Peak demand occurs at different times in different locations, and this has various implications at varying voltage levels of the network. Transmission network must contain sufficient capacity to carry enough electricity to meet the global peak demand for the region serviced. Whereas, distribution levels of the network must contain sufficient capacity to carry enough electricity to meet peak demand in every street. The points in time that peak demand occurs on assets in each street, is often different to the point in time the peak occurs for the whole region. Therefore, there are varying degrees of diversity in demand between the points in time that peaks occur across each street, and the points in time that peak demands occur on the backbone network.

In a positive demand growth environment, increasing peak demand may create the need for additional investment, dependent on detailed planning. Energex must maintain sufficient capacity and voltage stability to supply every home and business on the day of the year when electricity demand is at its maximum, no matter where those customers are connected in the network. In addition, growth in peak demand may occur where new property developments are being established. At the same time, over the same period, peak demand may be declining in areas where usage patterns are changing due to customer behaviour or from the impacts of alternative sources like solar PV and Battery Energy Storage Systems (BESS). This means that growth patterns of electricity demand may be flat on a global scale, but there may be pockets of insufficient network capacity emerging in local areas experiencing increasing peak demand or new development.

The 2021-22 summer peak set a new record high of 5,289MW on 2nd February 2022 between 2.30 and 3.00pm. The peak was created by the hot weather driving up air conditioning load, and widespread afternoon cloud cover reducing the available solar energy generated and increasing the load on grid supplied electricity. It is estimated that solar PV reduced the peak by around 486MW at this time.

1.4 Minimum Demand

Historically, Strategic Load Forecasting has focused on maximum demand, energy delivered, energy purchased and customer numbers. However, the uptake of solar PV in the residential, commercial and industrial sectors has created the need to forecast minimum demand on the Energy Queensland network.

The impact of a daily minimum demand caused by the increase of rooftop solar uptake affects the distribution network at three levels, all of which will affect CAPEX expenditure:

- System level – Oversupply during the middle of the day may force large solar generators to be switched off as ramp up times are quicker than coal fired power stations. To date Energy Queensland has been able to leverage voltage regulation at the transmission connection point to limit the need for downstream remediation, but increasingly this will not be possible as the transmission network runs out of transformer tap or 'buck' range
- Zone Substation level – Cyclic issues due to reverse flow may reduce the life of zone substation transformers
- At a Feeder level – May impact the stability of individual feeders causing voltage fluctuations which, in turn, impact protection settings at a feeder level. Given the high number of open and

closed delta regulators on Energex distribution feeder network, cogeneration settings on regulators would need to be revisited to ensure voltage levels on feeders remain at a stable level during the day.

Rooftop PV is driving an increasingly rapid change in the load on the network from the day to night. This may give rise to an expanded role for fast-ramping but more expensive generators to manage the transition and supply overnight - again limiting the economic viability of existing baseload and new renewable generators and increasing the cost of wholesale energy. Managing the transition may necessitate greater dynamic reactive plant and give rise to challenges in system operation.

In Energex's network, 45% of detached houses have a solar PV system connected, with an average inverter capacity of around 4.8kVA. The rapid uptake of solar PV has changed the way power travels through the network, from a purely one-way to bi-directional energy flow.

The high number of residential rooftop solar on the network along with forecast installations has shifted the daily minimum demand on the network from a night time minimum to a daytime minimum. Historically, Energex's minimum demand occurred in the late evening/early morning with the lowest overnight minimum demand recorded in 2002 with a low of 1,147MW. This record has now been surpassed with a daytime minimum which occurred on Sunday, 18 September 2022 with a minimum of 399MW. Although the minimum demand on the network was not negative, analysis of the historical minimum demand trend shows that, at a system level, daytime minimum demands for the Energex network could fall below zero within a few years.

1.5 Changes from Previous Year's DAPR

For consultation purposes, Energex is ensuring the DAPR remains relevant and evolves with ever changing market expectations. To this end, Energex has made a number of improvements in the 2021 DAPR, and a number of improvements are planned for future editions. These changes aim to make relevant information accessible and understood by all stakeholders, non-network providers and interested parties.

The following changes have occurred as compared to the 2021 DAPR:

- Update of Community and Customer Engagement chapter to align with customer interactions and engagement activities. Our engagement activities ensure we are meeting the unique and diverse needs of our communities and customers by continuously investing in talking and listening to our customers and other stakeholders about their expectations, concerns and suggestions
- Review and update of maximum demand forecasts over the next five years
- Addition of forecast use of distribution services by embedded generating units
- There were five projects approved with credible options having an estimated capital cost greater than \$6 million. Regulatory Investment Test for Distribution (RIT-D) information is listed in Section 6.4
- Review and update on Energex's demand side management policy, strategy and initiatives
- Addition of Emergency Frequency Control Schemes and Protection Systems
- Addition of Minimum System Load and Emergency Backstop Mechanism.

1.6 DAPR Enquiries

In accordance with NER 5.13.2(e), Energex advises that all enquiries and feedback relating to this document are to be submitted by email to the following address:

DAPR_Enquiries@energex.com.au

Energex welcomes feedback and any improvement opportunities identified by market participants and other stakeholders.

Chapter 2

Corporate Profile and Asset Management

- Corporate Overview
- Electricity Distribution Network
- Network Operating Environment
- Asset Management Overview

2 Corporate Profile

2.1 Corporate Overview

Energex (Energex Limited) is a subsidiary of Energy Queensland Limited, the Queensland government owned corporation formed through a merger in June 2016.

2.1.1 Vision, Purpose and Values

Energy Queensland’s corporate vision is to energise Queensland communities. Our purpose is to deliver secure, affordable and sustainable energy solutions with our communities and customers, and our SKILLED Values are as shown in Figure 2.

Figure 2 – Energy Queensland Vision, Purpose and Values

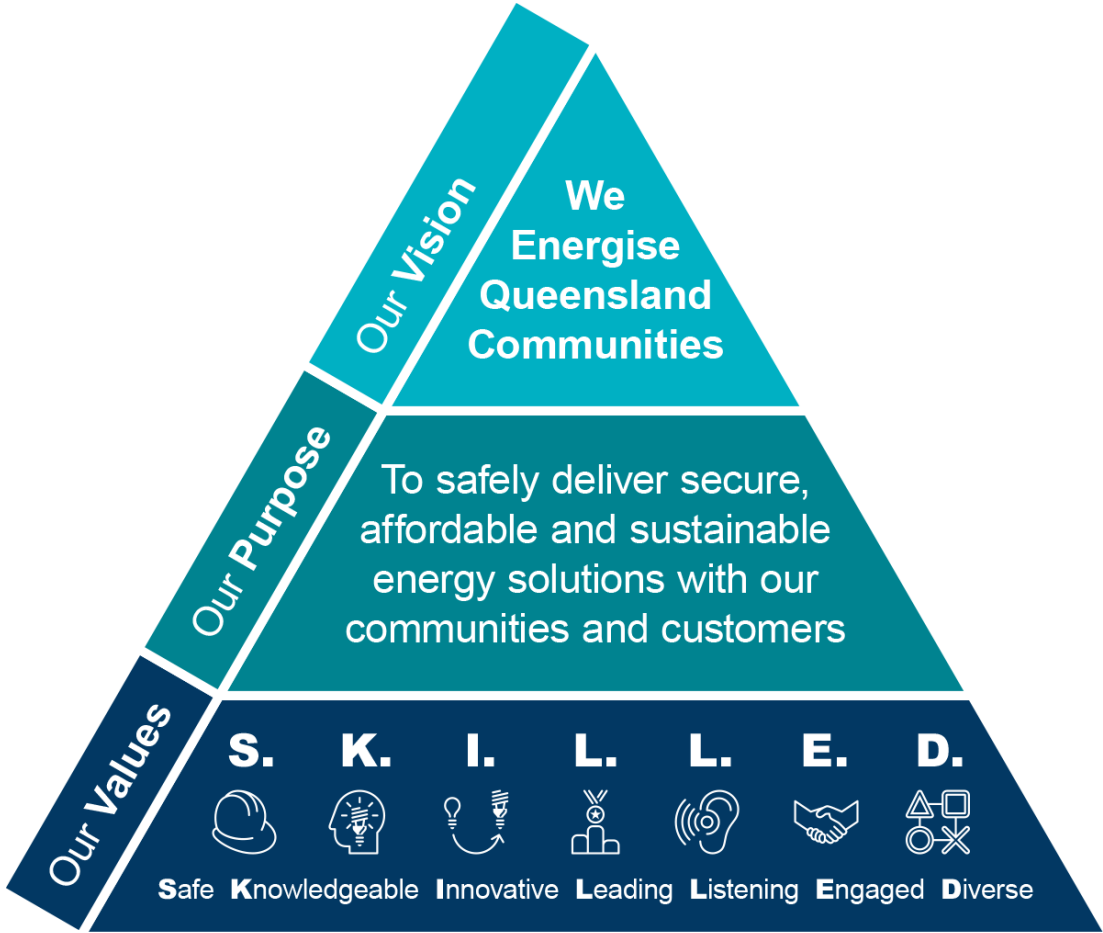

2.2 Electricity Distribution Network

Energex distributes electricity to over 1.6 million residential, commercial and industrial customer connections, supporting a population base of around 3.8 million in South East Queensland.

At the core of the business is a high performing electricity distribution network that consists of property, plant and equipment and assets valued at approximately \$12.5 billion.

The bulk of the electricity distributed enters Energex's distribution network through connection points into Powerlink Queensland's high voltage transmission network, which brings the electricity from the state's major generation plants. However, Energex also enables connection of Distributed Energy Resources (DER), such as solar energy systems and other embedded generators.

The Energex network is characterised by:

- Connection to Powerlink's transmission network at 27¹ connection point
- High density areas, such as the Brisbane Central Business District (CBD), and the Gold Coast and Sunshine Coast city areas, typically supplied by 110/11kV, 110/33kV, 132/33kV, or 132/11kV substation
- Urban and Rural areas where 110/33kV or 132/33kV bulk supply substations are typically used to supply 33/11kV zone substation
- Inner Brisbane suburban areas with extensive older, meshed 33kV underground cable networks that supply zone substation
- Outer suburbs and growth areas to the north, south and west of Brisbane, which are supplied via modern indoor substations of modular design
- New subdivisions in urban and suburban areas supplied by underground networks with pad mount substation.

Table 1 presents a summary of Energex's network and customer statistics over the past year. Changes in asset numbers over this timeframe have occurred as a consequence of demands for electricity, residential, commercial and industrial developments.

¹ Note: Count is distinguished by voltage level.

Table 1 – Summary of Network and Customer Statistics for 2021-22

Assets	2021-22
Total Overhead and Underground (km)	55,927
Lines – Length of Overhead (km)	
Total	35,098
LV (Low Voltage)	14,159
11kV	17,568
33kV	2,183
132kV and 110kV	1,188
Cables – Length of Underground (km)	
Total	20,829
LV	13,234
11kV	6,615
33kV	815
132kV and 110kV	165
Other Equipment (Quantity)	
Bulk Supply Substations	42
Zone Substations	246
Poles ¹	703,458
Distribution Transformers	52,111
Street Lights ²	401,010
Customer Numbers	
Residential	1,481,607
Other	133,713
Total ³	1,615,320

¹ All poles including customer poles and streetlight poles held on record.

² All streetlights including rate 3 streetlights.

³ Active and de-energised NMIs are counted. All other NMI status types are excluded.

All information as at June 30 each year.

Energex's assets are managed across six geographical areas. These hubs provide regional asset and resource management and can respond promptly to local network outages. The geographical boundaries for each area are shown in Figure 3.

Figure 3 – Energex Distribution Hubs

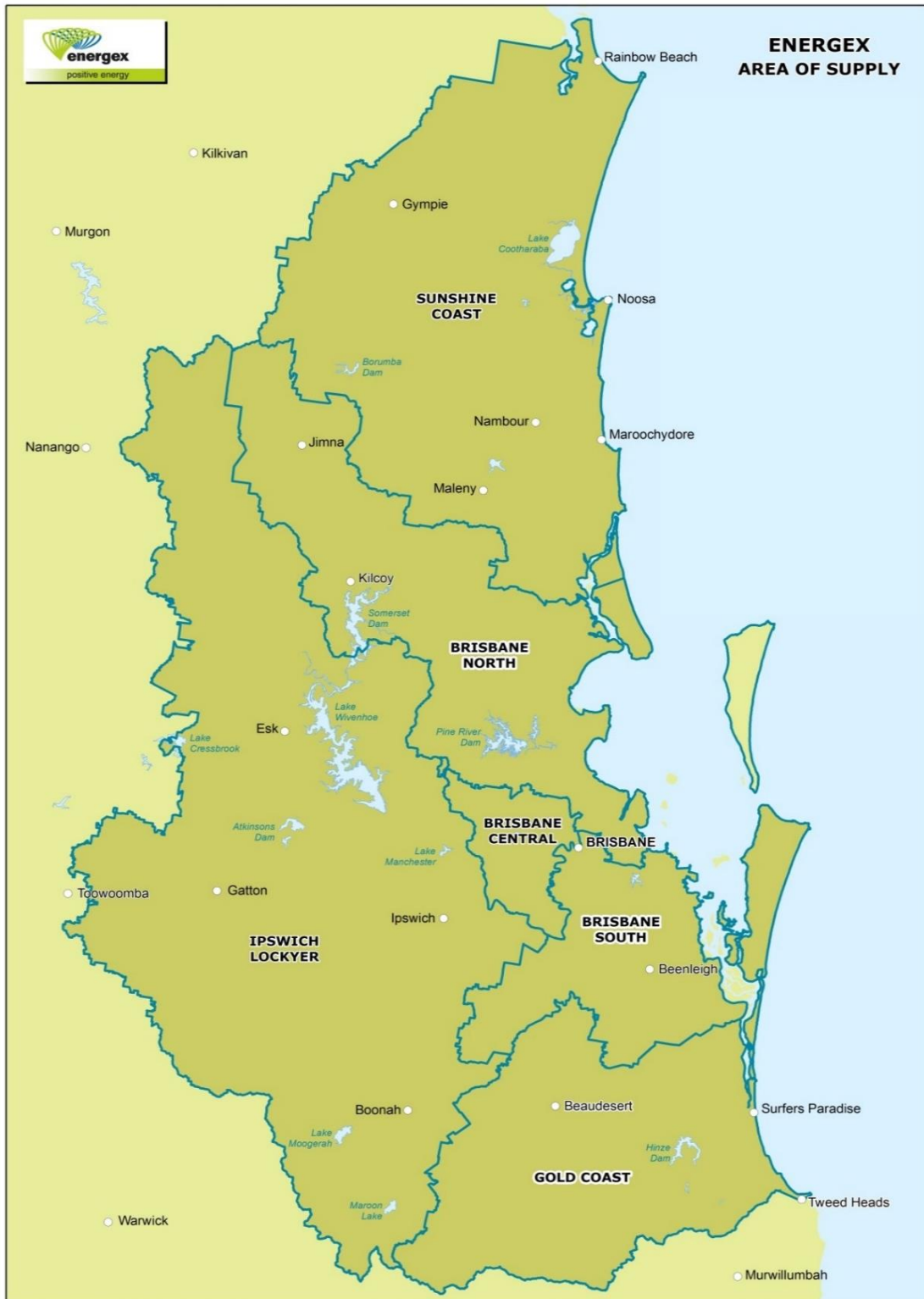

2.3 Network Operating Environment

This section presents key external drivers, associated industry impacts and our safety and environmental commitments that underpin our planning decisions in an operating environment increasingly dominated by distributed generation. Many of these have emerged from Energex's forward planning process which informs the identification of Energex's five-year business objectives covering this forward planning period. While customer demand is still the main trigger in our network augmentation decisions, bi-directional energy flow throughout the network is presenting new challenges particularly with respect to maintaining statutory voltage limits.

2.3.1 Physical Environment

South East Queensland (SEQ) experiences challenging environmental conditions in which to operate an electricity supply network.

Features of the region's climatic conditions impacting the distribution network are:

- High rainfall areas with rapid vegetation growth
- Periods of sustained high temperatures and/or high humidity
- Salt spray in exposed coastal areas resulting in reduced life of assets due to corrosion
- Bushfires, flooding and storm surges
- SEQ has some of Australia's highest incidence of Lightning activity.

Performance of the network under these conditions is discussed further in Section 9.3.

2.3.2 Shareholder and Government Expectations

We are continuing to increase the choices available to our customers, and enable renewable energy, by working to progress network tariff reforms and developing innovative energy-related solutions.

This supports the Queensland Government's target of 50% renewable energy by 2030, and net zero emissions by 2050.

With the support of the Queensland Government, we are continuing to facilitate the adoption of emerging storage technology, both Battery Energy Storage Systems (BESS) and Electric Vehicles (EVs).

2.3.3 Community Safety

Safety is the number one value for Energy Queensland – safety of our employees, our customers and the community. All business units within EQL play a part in ensuring community safety is maintained, however there are four key stakeholder business units who carry the bulk of responsibilities and accountabilities of ensuring the overarching program is maintained and remains effective.

The four key stakeholder business units are:

- Engineering – asset owner responsible for: Network Planning, Design, Maintenance, Operation and Electrical Safety of Network Assets
- Operations – Delivery of EQL's Program of Work (PoW) including construction, operation and maintenance of the network
- Customer – Coordinate and deliver Community Safety advertising and information campaigns in the market and liaison with Government and other key stakeholders in relation to community safety objectives, initiatives and concerns

- Services – Coordination of the Community Safety Steering Committee, incident management and analysis, internal and external reporting, SME on non-engineering matters.

Each of the four key stakeholder business units oversee, manage and contribute towards discrete aspects which, when assessed all together represent the overarching organisational approach to Community Safety.

Informed by incident data and learnings from investigating and attending incidents we continue to target industries at risk, who frequently work in close proximity to powerlines to raise awareness of the powerline safety dangers. This data identifies the industries with the greatest contact with powerlines - construction, aviation, agriculture, emergency services and transport.

Our important and long-running community safety campaign on powerline awareness has continued, supported by the lookup and live² online application that allows members of the community to pinpoint our overhead powerlines and power pole locations.

The 'app' was built by geospatially overlying powerlines onto imagery, enabling workers and others in the community to effectively plan activities near powerlines. Users are also able to examine worksites from various vantage points and identify the electrical hazards, assess powerline risks, implement appropriate control measures and access links with additional safety advice.

2.3.4 EQL Health, Safety and Environment Management System

The Energy Queensland Limited Health, Safety and Environment Management System (EQL HSE MS) has been developed to provide a framework to effectively manage health, safety, environment, cultural heritage and security risks across the organisation. This framework was modelled upon the existing management system requirements for Energex and Ergon Energy to enable the transition to a centralised management system. The management system is currently accredited to:

- ISO 14001:2015 Environment Management System
- ISO 45001:2018 Occupational Health and Safety Management System.

The management system consists of 12 Standards which are aligned to accreditation requirements. Standard 8 Control of Work consists of 14 Hazard Controls (HCs) to enable business units to implement fit for purpose risk controls. HCs include requirements which are accepted practice across Energy Queensland, which may exceed legal requirements and include:

1. Transport
2. Access and Entry
3. Community Safety
4. Plant, Tools and Equipment
5. Working with Electricity
6. Asset Safety
7. Manual Tasks
8. Hazardous Materials and Waste Management
9. Fit for Work

² Website:

<https://www.arcgis.com/apps/webappviewer/index.html?id=5a53f6f37db84158930f9909e4d30286>

10. Land and Water Management and Disturbance
11. Air, Energy and Greenhouse Gas
12. Occupational Health, Noise and Amenity
13. Security
14. Working at Heights.

The EQL HSE MS is subject to third party surveillance audits and the Electrical Safety Office (ESO) Electrical Entity audit conducted once per year.

2.3.5 Environmental Commitments

Energex is committed to reduce the environmental and cultural heritage impact of our operations as outlined in the Energy Queensland's [Environmental Sustainability & Cultural Heritage Policy](#)³. We will safely deliver secure, affordable and sustainable energy solutions for our customer and communities through reducing our carbon emissions, supporting increased connection of renewable, implementation of our First Nations Reconciliation Action Plan and create energy security for our communities in times of natural disasters.

The Energex electricity network traverses diverse environmental and culturally significant areas including coastal, rural and urban landscapes. The ISO 14001 (Environment) certified Energy Queensland Integrated Management Systems (IMS) provides an effective operational framework to plan, implement, monitor and improve our services with balanced consideration of the risks and opportunities to our environment, cultural heritage and communities. We implement and support robust systems and processes founded in legislative compliance, set and transparently report on objectives and targets to continually improve environmental and cultural heritage outcomes.

The [Energy Queensland Low Carbon Future Statement](#)⁴ outlines our support of Queensland's transition to a low carbon future, the management of our greenhouse gas emissions and the implementation of plans to build greater resilience to mitigate the potential risks of a changing climate.

2.3.6 Legislative Compliance

Energex Limited is a wholly owned subsidiary of Energy Queensland Limited which is a Queensland Government Owned Corporation (GOC).

The two shareholding Ministers to whom Energy Queensland Limited's Board report under the *Government Owned Corporations Act 1993 (Qld)*, are:

- Treasurer and Minister for Trade and Investment
- Minister for Energy, Renewables and Hydrogen and Minister for Public Works and Procurement.

Energex operates in accordance with all relevant laws and regulations, including:

- *Government Owned Corporations Act 1993 (Qld)*
- *Electricity Act 1994 (Qld)*
- *Electricity Regulation 2006 (Qld)*
- *Electricity Distribution Network Code*
- *Electricity – National Scheme (Queensland) Act 1997*

³ [Environmental Sustainability & Cultural Heritage P058 \(energyq.com.au\)](#)

⁴ [Low Carbon Future Statement Policy \(energyq.com.au\)](#)

- The National Electricity (Queensland) Law as set out in the schedule to the *National Electricity (South Australia) Act 1996*
- The National Electricity (Queensland) Regulations under the *National Electricity (South Australia) Act 1996*
- The National Energy Retail Law as set out in the schedule to the *National Energy Retail Law (South Australia) Act 2011*
- The National Energy Retail Regulations
- The National Electricity Rules and National Energy Retail Rules
- *Electrical Safety Act 2002* (Qld)
- *Electrical Safety Regulation 2013* (Qld)
- *Work Health and Safety Act 2011* (Qld)
- *Work Health and Safety Regulation 2011* (Qld)
- The Electrical Safety Codes of Practice 2019, 2020 and 2021
- State and federal environment and planning laws, including the *Environment Protection and Biodiversity Conservation Act 1999* (Cth), *Environmental Protection Act 1994* (Qld) and *Planning Act 2016* (Qld).

2.3.7 Economic Regulatory Environment

Energex is subject to economic regulation by the Australian Energy Regulator (AER) in accordance with the National Electricity Law and Rules. The AER applies an incentive-based regulatory framework that encourages Energex to provide services as efficiently as possible. The AER does so by setting the maximum regulated revenues that we are allowed to recover from our customers during each year of the regulatory control period. The revenues are based on an estimate of the costs that a prudent and efficient network business would incur to meet its regulatory obligations. Given that the revenues are locked in at the start of the period, we have a general incentive to provide our services at less than the forecast costs and keep the difference until the end of the regulatory period. In the following period, we share the benefits of efficiencies with our customers.

This general incentive framework is complemented by a suite of guidelines, models and incentive schemes, including, amongst others, the:

- Efficiency Benefits Sharing Scheme (EBSS) and the Capital Expenditure Sharing Scheme (CESS), which encourage us to pursue efficiency improvements in OPEX and CAPEX and share them with customers
- Service Target Performance Incentive Scheme (STPIS) which encourages us to set, maintain or improve service performance
- Demand Management Incentive Scheme (DMIS) and Demand Management Innovation Allowance Mechanism (DMIAM), which encourage us to pursue non-network options
- Regulatory Investment Test for Distribution (RIT-D), which requires us to undertake a cost-benefit analysis and consult with stakeholders before undertaking major investments
- Ring-fencing Guideline, which requires us to separate our regulated services from contestable services.

On 5 June 2020, the AER published its Final Distribution Determination for Energex for the 2020-25 regulatory control period, commencing 1 July 2020 to 30 June 2025. More information regarding Energex's allowed revenues and network prices can be found on the AER's website (www.aer.gov.au).

2.4 Asset Management Overview

Management of Energex's current and future assets is core business for Energex. Underpinning Energex's approach to asset management are a number of key principles, including making the network safe for employees and the community, delivering on customer promises, ensuring network performance meets required standards and maintaining a competitive cost structure.

This section provides an overview of Energex's:

- Best Practice Asset Management
- Asset Management Policy
- Strategic Asset Management Plan (SAMP)
- Network Investment Process.

2.4.1 Best Practice Asset Management

Energex recognises the importance of maximising value from assets as a key contributor to realising its strategic intent of achieving balanced commercial outcomes for a sustainable future. To deliver this, Energex's asset management practice must be effective in gaining optimal value from assets.

Energex is continuing to reshape its asset management practice to align with the ISO 55000 standard. This transition is a significant undertaking and will span several years, so a phased approach has been initiated focused on building capability across all seven major categories covered by the standard (i.e. Organisational Context, Leadership, Planning, Support, Operation, Performance Evaluation and Improvement).

2.4.2 Asset Management Policy

The asset management policy provides the direction and broad framework for the content and implementation of Energex's asset management strategies, objectives and plans. The policy directs Energex to undertake requirements associated with safety & people, meeting customer needs, and the commitment to ensure asset management enablers and decision-making capability meets the current and future needs of Energex.

This policy together with the Strategic Asset Management Plan (SAMP) are the primary documents in the asset management documentation hierarchy and influence subordinate asset management strategies, plans, standards and processes.

2.4.3 Strategic Asset Management Plan

Energex's SAMP is the interface that articulates how organisational objectives are converted into asset management objectives as shown in Figure 4. The SAMP also sets the approach for developing asset management plans and the role of the asset management system in supporting achievement of the asset management objectives.

Figure 4 – SAMP translates Corporate Objectives to Asset Management Objectives

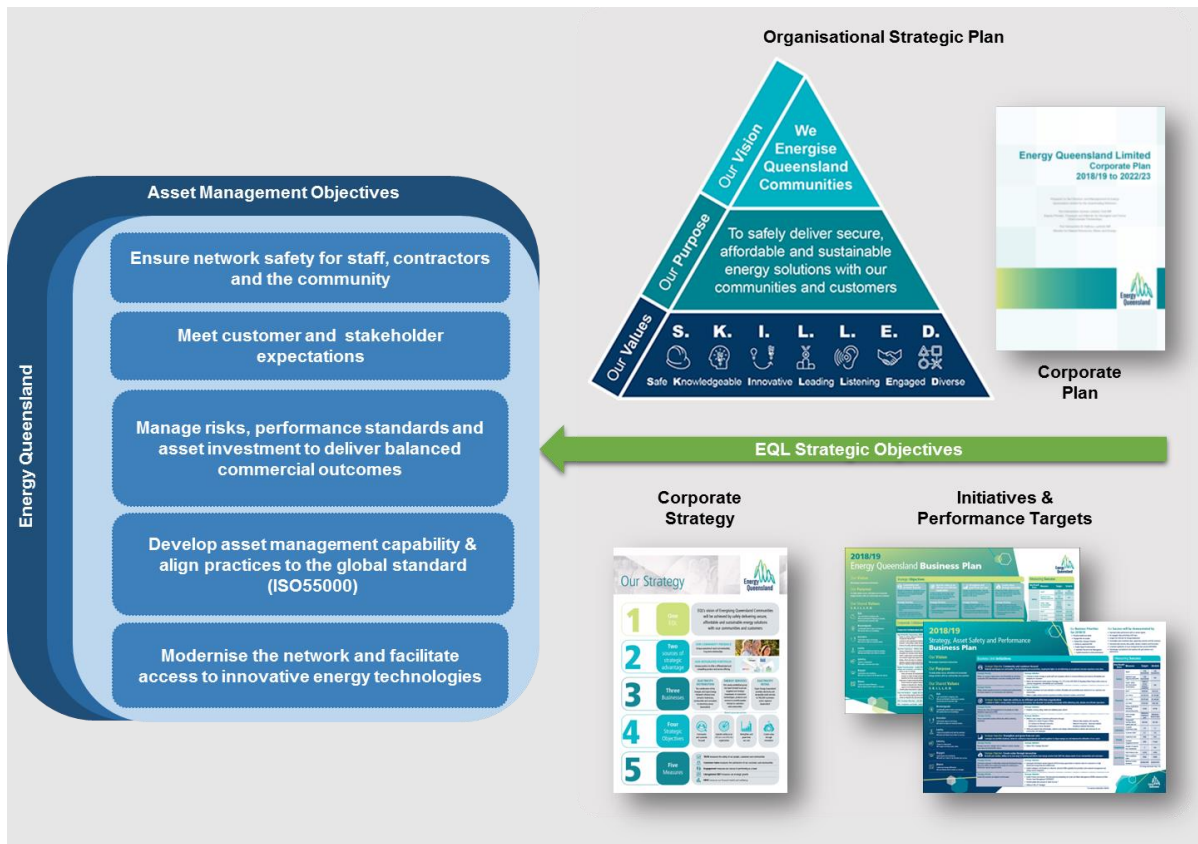

2.4.4 Investment Process

2.4.4.1 Corporate Governance

Energex has a four-tier governance process to oversee future planning and expenditure on the distribution network as shown in Figure 5.

Central to Energex’s governance process is legislative compliance. The Government Owned Corporations (GOC) Act requires the submission of a Corporate Plan (CP) and Statement of Corporate Intent (SCI) while the NER requires preparation of the DAPR. The network investment portfolio expenditure forecast is included in the five-year Corporate Plan and Statement of Corporate Intent.

Figure 5 – Program of Work Governance



The four tiers include:

1. **Asset Management Strategy & Policy:** Alignment of future network development and operational management with Energex strategic direction and policy frameworks to deliver best practice asset management
2. **Grid Investment Plan:** Development of seven year rolling expenditure programs and a 12-month detailed Program of Work (PoW) established through the annual planning review process. The Governing entities oversee
 - Fulfilment of compliance commitments
 - Ensure the network risk profile is managed and aligned to the corporate risk appetite
 - Approval of the annual network Programs of Work and forward expenditure forecasts.
3. **PoW Performance Reporting:** Energex has specific corporate Key Result Areas (KRA) to ensure the PoW is being effectively delivered and ensures performance standards and customer commitments are being met. Program assurance checks including review of operational and financial program performance is overseen by senior management through the monthly Works Program Committee to ensure optimal outcomes with appropriate balance between governance, variation impact risks, emerging risks and efficiency of delivery. A comprehensive PoW scorecard is prepared monthly and key metrics are included in the Operational Delivery which is a corporate Key Performance Indicator (KPI) that, with monthly performance reporting for key projects, informs the Executive and Board. Quarterly PoW updates are provided to the Board
4. **Project and Program Approval:** Network projects and programs are overseen by senior management and subject to an investment approval process, requiring business cases to be approved by an appropriate financial delegate.

2.4.5 Network Risk Management and Program Optimisation

Management of risk is a crucial foundation for effective asset management and an integral part of ISO 55000 Asset Management suite of standards. Energy Queensland's Network Risk Management Framework ensures we apply a consistent approach to the assessment of network risks. It aligns with AS/NZS ISO 31000:2009 Risk Management - Principles & Guidelines and with Energy Queensland's Portfolio Risk Management Framework. Energy Queensland continuously reviews inherent and emerging network risks to ensure optimisation of our projects and programs.

Network risk is assessed according to the following five risk categories:

- Safety
- Environment
- Legislated Requirements
- Customer Impacts
- Business Impacts.

Risk assessment involves development of credible scenarios that may lead to a specific risk consequence. This is followed by estimation of the likelihood of occurrence and subsequent development of a risk rating for each scenario. Projects and programs of work are then considered for inclusion in the PoW on a priority basis to deliver appropriate network-wide risk mitigation. Energex Network optimises its PoW to balance the inherent risk should some programs not proceed, it considers; cost and funding constraints, resourcing availability, performance targets and other project drivers including fulfilment of strategic objectives.

2.4.6 Further Information

Further information on our network management is available on the Energex website⁵.

⁵ Website: <https://www.energex.com.au/about-us>

Chapter 3

Community and Customer Engagement

- Overview
- Our Engagement Program
- What We Have Heard
- Our Customer Commitments

3 Community and Customer Engagement

3.1 Overview

To ensure we are meeting the unique and diverse needs of our communities and customers we engage regularly with our customers and other stakeholders on their thoughts, needs, expectations, and concerns.

With our industry undergoing a period of rapid transformation, an open dialogue is critical to enabling diversity of thought, innovation and, ultimately, more now than ever, better, more sustainable, customer-focused solutions. Across our group we operate a coordinated, multi-channel community and customer engagement and performance measurement program. These conversations, and the focus they provide, are fundamental to creating real long-term value for our customers, our business, and Queensland.

Our engagements continue to influence the asset management strategies and investment plans covered in this report and help to align our future thinking with the long-term interests of our communities and customers.

This year's engagements built on earlier extensive engagement around the network businesses' network investment plans and our Regulatory Determination for 2020-25, and our network tariff reform program, as well as focusing on the economic, social, environmental and governance topics relevant to our business that matter most to our different stakeholders.

This chapter provides an overview of our engagement activities and describes how they enable us to put our communities and customers at the heart of everything we do.

More information is available in our [Annual Report, and the companion document Towards and Electric Life 2030, and our Energy Charter Disclosure Report](#)⁶, and the [2020 and Beyond Community and Customer Engagement Report](#)⁷ published with our Regulatory Determination.

⁶ Website: <https://www.energyq.com.au/publications>

⁷ Website: <https://2020 and Beyond Community and Customer Engagement Report>

3.2 Our Engagement Program

3.2.1 Customer and Community Council and Other Forums

This year saw the renewal of the Energy Queensland Customer Council, now renamed the Customer and Community Council. The Council's new charter and broader membership have been to ensure not only our customers, but the wider community voice is captured in our engagements. To better support these representatives in engaging with the business, we introduced remuneration for the group's members to assist in capacity building and supporting their ability to engage.

We also established a Tariff Reform Working Group (TRWG), made up of industry and stakeholder representatives, with the aim of co-designing potential new network tariffs to be trialled with residential customers in 2022-23. The customer insights from this will inform our future reforms for Ergon Network's and Energex's next respective Tariff Structure Statements.

Network tariff reform is a complex topic that requires a balance between the needs of customers, the business and the Australian Energy Regulator, so it is vital that we bring our customers on the network tariff reform journey. Both the Customer and Community Council and TRWG are now bringing a broad cross section of voices to the table.

We also continue to support forums for major customers, local government and the agricultural sector to discuss topics relevant to specific customer groups.

3.2.2 Working with Industry Partners

We engage actively with our industry partners, both strategically and operationally.

The [Energy Charter⁸](#), of which we are a signatory, continues to provide a platform for collaboration with organisations from across the energy industry, building accountability across the supply chain and improving customer outcomes.

Direct engagement and service relationships with the different energy retailers who operate across the Queensland market also remains critical to delivering for our customers.

Our industry engagement also includes participation, with industry memberships, in state-wide forums and operational engagement to listen and share knowledge with electrical contractors, solar supplier/installers and property developers. These channels of communications are increasingly important to us as we move forward.

3.2.3 Community Leader Engagement

To better connect with our communities and ensure we are effective in our service delivery, we have 17 established operational areas across Queensland. Each area has a locally based manager who build relationships with our local community stakeholders and understand the areas unique concerns.

To support local stakeholder engagement, we also host Board stakeholder events regionally to ensure we keep in touch with our communities' expectations. While this remains challenging with the ongoing impact of COVID-19, they are considered to provide an important means for our Directors, the Executive and a wide group of managers and decision-makers to interact with local stakeholders and customers.

⁸ Website: <https://www.theenergycharter.com.au>

3.2.4 Online Engagement

We continue to use our digital engagement platform [Talking Energy](https://www.talkingenergy.com.au),⁹ as an effective tool to interact with targeted stakeholders, as well as a channel to reach a wider audience across Queensland as we engage on key energy topics and issues.

It has been especially useful this year in consulting with industry stakeholders on enabling dynamic customer connection for Distributed Energy Resources (DER) and for engaging community stakeholders interested in our Local Network Battery Plan, which is seeing utility-scale, network-connected batteries installed across regional Queensland to support the state's continual uptake of renewable energy.



3.2.5 Our Customer Research Program

This year, we embedded two new corporate measures; Customer Satisfaction (CSAT) and a Net Trust Score (NTS), to put customers at the centre of our decision-making. These new metrics are based on tracking research around our customer experience and social license or reputation that enables us to benchmark our brands against other businesses and help us raise the bar.

To target service improvements, we also continued to survey the customer experience following our key service interactions for each customer group, from the large businesses to our residential customers. Overall trends for satisfaction for each service, as well as specific feedback, from these surveys are used across the Group.

Our third tracking survey is the [Queensland Household Energy Survey](#).¹⁰ Funded by Energex and Ergon Energy Network in conjunction with Powerlink Queensland, this survey tracks customer perceptions and overall attitudes to electricity prices and power supply reliability, as well as energy use and energy efficiency behaviours, and interest in emerging energy-related technologies.

These were also supported by a program of additional market research activities used to explore specific topics more deeply, for example qualitative customer journey mapping to obtain insights into the customer experience around the purchase and charging behaviours of electric vehicle owners, and a customer survey with flood affected customers to obtain insights in to their experience of interacting with the network business as part of our disaster response to the February/March 2022 floods in Southern Queensland.

Additionally, we have also undertaken a second comprehensive materiality assessment of our Environmental, Social and Governance issues to better identify and prioritise the topics that matter most to our stakeholders. This review, which included stakeholder interviews, was important to maintaining a deep understanding of the contribution we can best make to sustainability, considering our rapidly changing operating environment, and the evolving priorities of stakeholders and issues important to the business. For more on this, refer to the online report [Towards an Electric Life 2030](#).¹¹

⁹ Website: <https://www.talkingenergy.com.au>

¹⁰ Website: <https://www.talkingenergy.com.au/qhes>

¹¹ Website: [Towards an Electric Life 2030](#)

This year's research builds on the [in-depth research undertaken](#),¹² both qualitative research (deliberative forums and focus groups) and quantitative research, to inform our Regulatory Determination, and the asset strategies and future works programs outlined in this report.

3.3 What We Have Heard

Through our engagement activities we continue to hear the following key messages:

- Safety should never be compromised – and it is an area where we could be 'smarter'
- Electricity affordability remains a concern for many customers – both from a cost of living and a business competitiveness perspective
- Our communities and customers value how we go about keeping the lights on, especially our response to severe weather events and other natural disasters
- Our customers want greater choice and control around their energy solutions
- Interest in renewables and growing concerns around climate change is fuelling customer and community expectations around the transition to a low carbon economy
- The economic environment continues to bring 'energy inclusion and customer vulnerability' and 'economic resilience and jobs' to the foreground.

3.3.1 Safety First

There is recognition across our communities and customers of the dangers of electricity, and that if the network is not appropriately managed it presents a risk to our communities and employees. We are expected to be vigilant, and to always make safety our priority.

Community education on electrical safety awareness is seen as important, especially during natural disasters.

Our customers expect that we continue to adopt technology and process improvements to look for smarter ways to deliver improved safety outcomes.

Our highest performing 'trust driver' in our NTS research *'Is strongly focused on safety'*, followed by *'They are a local employer'*.

Our community's health concerns around the COVID-19 pandemic, especially in our First Nations communities, continues to have implications for our operational response.

¹² Website: <https://www.talkingenergy.com.au/haveyoursay>

3.3.2 More Affordable Electricity

Pricing

Electricity affordability remains a concern for many of our customers, both from a cost of living and a business competitiveness perspective.

We track price and affordability perceptions in our annual [Queensland Household Energy Survey](#).¹³

Despite a number of years of tariff relief, the current volatility in the wholesale energy markets, and the associated rise in electricity prices, is leading to concerns about value and the disruption across the industry.

Customers generally do not consider network charges separately to their retail electricity bill. They simply expect the industry as a whole to deliver electricity price relief, without comprising the safety, security or reliability of supply or customer service standards.

Network Tariffs

Our customers are looking for tariffs that offer simplicity, savings, value and choice, and that reward them for their role in energy transition.

In the [2022 Queensland Household Energy Survey](#),¹⁴ 53% of customers indicated their willingness to change how they use electricity to manage both peak and minimum demand if they had a better understanding of what the personal benefits would be, with 40% indicating interest in time of use electricity pricing where they would pay less during the day and more during the evening when peak demand is an issue.

While informed stakeholders recognise that network tariff reform is needed to respond to the changes in the market and to deliver sustainable charges for the future, more engagement is required to further advance reforms for future years with customer tariff trials commencing in late 2022 to obtain insights into customer understanding and impacts of proposed new network and retail tariff options.

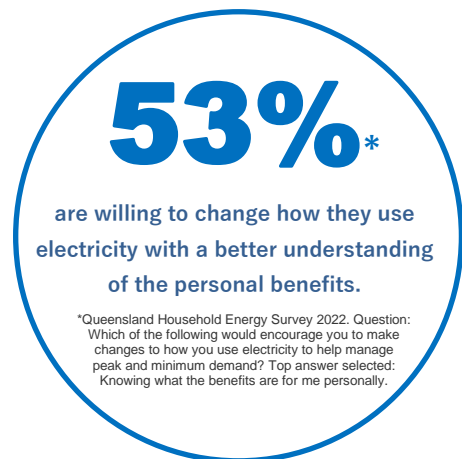
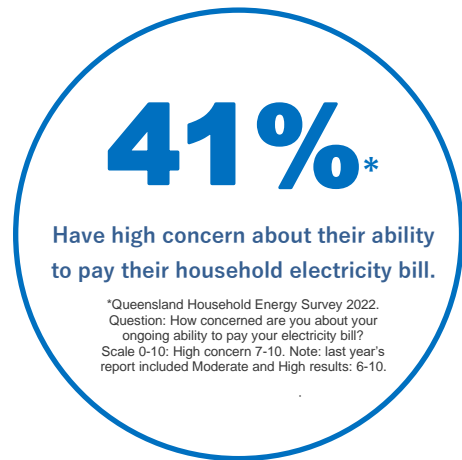

¹³ Website: <https://www.talkingenergy.com.au/qhes>

¹⁴ Website: <https://qhes.com.au/wp-content/uploads/2022/08/2022-QHES-Report.pdf>

Fairness

It is clear that we have a corporate responsibility in providing an essential service to do all we can to address electricity affordability, and to deliver to all Queenslanders whether ‘coast or bush’.

There remains concern around the ability of some to respond to the changes taking place in the industry. Together, we need to ensure everyone benefits equitably from solar and other emerging technologies and that vulnerable segments of the community are not left behind.

From a network tariff perspective, being ‘fair and equitable’ is both about minimising cross subsidies and managing the social and economic impact of any move to more cost reflective pricing.

There is also a need as a trusted advisor to provide independent impartial advice, and to help customers make informed choices in their energy use and behaviours.

3.3.3 A Secure Supply – Keeping the Lights On

Emergency Response

Queenslanders know that storms, cyclones, bushfires, floods and other disasters are beyond anyone’s control. Customers’ feedback on the natural disaster events we responded to continues to show we respond well when these events occur and that our contribution is important to communities in getting them back up and running quickly.

More than 180,000 customers lost power during the major floods and associated severe storms that occurred in Brisbane and across southern Queensland in early 2022. At its peak more than 57,000 customers were without electricity supply at any one time. In response, Energex and Ergon Network field crews and support teams were mobilised and worked tirelessly to safely restore network supply to all customers who could be safely reconnected.

Despite the ongoing impact of natural disasters across the network, 61% of participants in the 2022 [Queensland Household Energy Survey](#)¹⁵ indicated they have a positive sense of security around their electricity supply.

The second phase of the Thriving Communities Partnership Queensland Chapter’s [Disaster Planning and Recovery Collaborative Research Project](#)¹⁶, which has built on the national virtual roundtable in late 2020, strengthened our understanding of the relationship between the experiences of individuals, first responders and front-line service providers. The research highlights the ‘gatekeeper’ role electricity plays to action before and after a disaster; how the communications across the journey influence response and recovery; and provides a range of other insights. This has advanced collaborative opportunities for positive change.

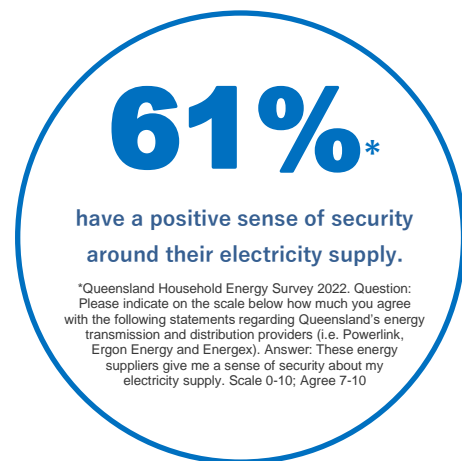

¹⁵ Website: <https://www.talkingenergy.com.au/qhes>

¹⁶ Website: <https://thriving.org.au/what-we-do/disaster-planning-and-recovery>

Reliability

General perceptions of Queensland's energy supply have continued to improve, with most customers agreeing that they have a reliable supply of energy.

Growing year-on-year, 74% of survey participants agreed they were provided with a 'reliable energy supply'. Sentiment that price and reliability are well balanced has also continued to increase in the 2022 [Queensland Household Energy Survey](#).¹⁷

Power outages have a range of immediate customer and broader economic impacts. The quality of supply is also important to some customers. Some customers, however, especially those in the more rural and remote areas of our network, consider they are poorly serviced.

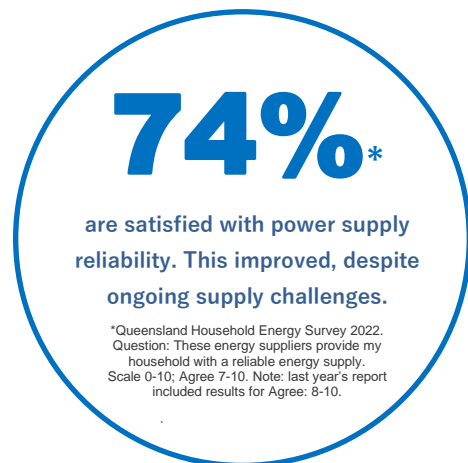

Customer Experience

This year we implemented our new corporate Customer Satisfaction (CSAT) metric approach, which involves surveying customers quarterly via an independent panel asking how satisfied they are with the services receive by the business. The new corporate CSAT metric measures customer satisfaction across all our brands with an indexed score provided for Energy Queensland. This year our CSAT recorded a score of 72.2/100, above our target (69/100) and stretch target (70/100). Importantly, the key CSAT drivers tracked indicate that as mentioned previously in this report our customers are generally satisfied that we *'provides a reliable power supply'* and in our ability to *'deliver work in a timely manner'* our top scoring key drivers, but that we have further progress to make in our drive to be *'customer focused'* and *'understand my [our customers'] needs'*.

As our interactions and research indicates, expectations around the customer experience are generally increasing, especially around handling their enquiries in a timely manner and in regard to information and notifications on issues such as power outages. Many see outage updates and restoration times as important as preventing the initial outage, a fact highlighted through the 2022 [Queensland Household Energy Survey](#)¹⁶ results, where 62% of respondents indicated they were satisfied with the time taken to restore electricity to their home after an outage, but only 38% satisfied with the communications around the outage.

Generally, our stakeholders support us in using technology to improve efficiency and reduce costs, but we note that the scale of our digital transformation program is significant and that this creates some stakeholder concerns around potential business and service disruption.

¹⁷ Website: <https://www.talkingenergy.com.au/qhes>

3.3.4 A Sustainable Future

Network as an Enabler

The number of households indicating their intention to consider installing solar energy continues to rise year on year, with many also now indicating interest in home battery storage systems. In the 2022 [Queensland Household Energy Survey](#)¹⁸, 15% of respondents indicated their intention to purchase battery storage within the next three years with a further 36% indicating a desire to do so within the next 3-10 years. These intentions could see around 150,000 home battery systems in use by 2030.

In the survey, over a third (34%) of participants were aware of the concept behind community batteries.

The growth in solar is changing the shape of load profiles across the day, and throughout the year, 'hollowing out' the load during the middle of the day. This has significant implications for the grid with the potential to impact system stability, and reverse power flows and voltages issues.

In the 2022 Queensland Household Energy Survey we found just under half (49%) of our customers are potentially aware of the need to manage minimum demand on the electricity network, rising to 61% amongst those who have solar PV.

With Electric Vehicles (EV) potentially being a significant load on the network in the coming years, the 2022 Queensland Household Energy Survey also continued to track perceptions on EVs.

Consideration of EVs has significantly increased, with 71% of survey participants that are considering purchasing a new vehicle in the next three years willing to consider an EV, up from 54% in 2020. Price and charging ability are the main barriers for many, with 59% indicating they are still too expensive and 43% highlighting concerns over lack of public charging stations.

The majority of the EV owners who participated in the survey indicated their willingness to personally manage their EV charging time to avoid peak electricity demand on the network (63%), with just over half (53%) also indicating they were open to the concept of a third party, such as their electricity network

26%*

intend to purchase new or additional solar energy for their home within the next three years.

*Queensland Household Energy Survey 2022. Question: Do you intend to purchase additional or replacement solar panels for your home within the next 3 years? / Do you intend to purchase solar panels for your home within the next 3 years?

49%*

are aware of the need to manage minimum demand on the electricity network.

*Queensland Household Energy Survey 2022. Question: Due to the high take up of rooftop solar PV systems, this creates high export of electricity to the grid and households using less electricity from the grid between 9am and 3pm than other times of the day. This is known as minimum demand. Are you aware of the need for electricity distributors to manage minimum demand on the grid?

71%*

of those considering purchasing a motor vehicle would consider an EV, versus 54% in 2020.

*Queensland Household Energy Survey 2022. Question: to those considering purchasing a motor vehicle in the next 3 years, would you consider purchasing a plug-in electric car or plug-in hybrid car in the next 3 years?

87%*

said it was important we modernise our electricity networks to continue to enable customers to take up new technologies.

*Future Energy Survey. Question: How important is it that we modernise our electricity networks to continue to enable customers to take up new technologies? 'Don't know' excluded.

¹⁸ Website: <https://www.talkingenergy.com.au/qhes>

provider, managing their charging to address electricity demand.

From earlier research we know our customers expect us to be able to facilitate and accommodate integration of renewables, battery storage and electric vehicles into the network, without creating risks to network security, supply quality or performance.

Despite the challenges of managing solar on the network and keeping voltages within statutory limits, across our networks we are continuing to see a decrease in the number of quality of supply enquiries lodged by customers. However, the largest proportion of these continue to be concerns relating to solar PV related issues as listed in Chapter 10.

Collaboration

Our customers, communities and other stakeholders, expect us to keep them informed in a timely manner and engage with them transparently and meaningfully on a regular basis.

Findings from research into our business customers' experience during power outages showed that while customers were highly supportive of the networks' need to conduct work relating to reliability, there were opportunities to support customers in preparing contingency plans and improve communications.

Across our industry's peak bodies and other stakeholders there is a strong desire to engage and work with us to realise the benefits from today and tomorrow's emerging technologies, and a recognition of the valuable role the network provides in the energy transformation.

This remains vital, with only 44% nationally in the Energy Consumers Australia's [Sentiment Survey June 2022](#)¹⁹ confident the market is working in their long term interests. In the context of this, in our own research, we are gaining more of an understanding around trust – 'working to make electricity more affordable' and 'to do the right thing'.

Information and awareness will remain important. Customers need to be informed to take advantage of emerging technologies and participate in the market. Vulnerable customers must not be left behind – information is important to removing barriers to participation.

Our demand management program continues to be viewed positively, with our stakeholders expecting us to collaborate with, and provide incentives to, customers and the supply chain to assist in demand management delivery and uptake. This collaboration is being outworked by [Ergon Energy and Energex's Demand Management Plan](#),²⁰ which seeks utilise customer and non-network service provider participation to address any network limitations. We have a variety of means to which stakeholders become informed about network limitations and express interest and indicate ability for participation on non-network solutions.

Connections

Reasonable, clear timeframes and costs for connections are critical to Queensland's economic development. Customers are seeking a simplification of our connection process, shorter time frames,

¹⁹ Website: <https://ecss.energyconsumersaustralia.com.au/sentiment-survey-june-2022>

²⁰ Website: https://www.energex.com.au/data/assets/pdf_file/0010/1006669/Demand-Management-Plan-2022-23.pdf

and for continued equitable support of embedded generator connections. There continues to be support for our efforts to align our service offering across Queensland.

3.4 Our Customer Commitments

As part of our planning process for our Regulatory Determination, we responded to the community and customer insights we heard at the time with a set of commitments for 2020 to 2025. Our Customer Commitments, provided on the following page, continue to prioritise our investment plans, including the strategies and specific investments reflected in this report.

OUR CUSTOMER COMMITMENTS

SAFETY FIRST

Our priority is to be Always Safe – to show leadership in health, safety and wellbeing across our industry and the broader community.

AFFORDABLE

We continue to look for ways to make electricity more affordable across our networks, and to advocate for the reforms needed for a bright energy future all Queenslanders.

PRICING

To help take the pressure off electricity prices, we'll continue to drive down the cost of distributing the electricity across Queensland.

NETWORK TARIFFS

Our tariff and other reforms will be transparent, fair and equitable. We'll continue to show leadership in the energy transformation – with reforms that help to realise the potential value of emerging technologies.

FAIRNESS

We recognise the need to support our customers and communities, especially during times of vulnerability. We are committed to delivering responsibly on what really matters so that no-one is left behind and our communities grow stronger.

SECURE

We're here 24/7 to keep the lights on – providing the peace of mind of a safe, reliable electricity supply, and from knowing that we'll be there 'after the storm'. We're here to make life easy.

EMERGENCY RESPONSE

We'll be there after the storm, prepared and with the resources to safely respond to whatever Mother Nature delivers. And work closely with others in emergency response.

RELIABILITY

We'll maintain recent improvements in power reliability – and continue to improve the experience of those being impacted by outages outside the standard.

SERVICE PROMISE

We'll strive to find new ways to provide a great customer experience – to make it easy. And we'll meet our Guaranteed Service Levels – if we don't, we'll pay you.

SUSTAINABLE

Making it easier to connect to the network – we give you as much control as you choose for your energy solutions with information and more sustainable choices.

NETWORK AS AN ENABLER

We're looking to the future and evolving the network to best enable customer choice in their electricity supply solutions. We'll innovate to integrate solar, batteries and other technologies with the network in a way that is cost effective and sustainable.

COLLABORATION

We'll engage with you and provide you with the information you need, when and how you need it, to support sustainable energy choices.

CONNECTIONS

We'll make it easier and more timely to connect to the network, helping you from beginning to end, with an aligned state-wide service offering and further system improvements.

Chapter 4

Network Forecasting

- Forecasting Assumptions
- Substation and Feeder Maximum Demand Forecasts
- System Maximum Demand Forecast

4 Network Forecasting

Forecasting is a critical element of Energex's network planning and is essential to the planning and development of the electricity supply network. Growth in peak demand is not uniform across the state of Queensland, therefore electrical demand forecasts are used to identify emerging local network limitations and network risks needing to be addressed by either supply side or customer-based solutions. Peak demand forecasts then guides the timing and scope of capital expenditure (to expand or enhance the network), or the timing required for demand reduction strategies to be established, or for risk management plans to be put in place.

A brief summary of the methodology and assumptions underpinning Energex's peak demand forecasts has been provided in this Chapter.

A Strategic Forecasting Annual Report is available detailing further discussion on the methodology and assumptions applied in the peak demand forecasts and including:

- Minimum demand forecasts
- Energy purchases and energy sales forecasts
- Customer number forecasts
- Distributed Energy Resources forecasts (solar PV, electric vehicles and battery storage systems)
- Economic and demographic forecasts and commentary relating to population growth, GSP and the Queensland economic outlook.

4.1 Forecast Assumptions

While there are a multitude of factors which influence each of the forecasts, there are also a number of key factors which have a wide-reaching impact.

4.1.1 Economic Growth

The level of economic activity is a major influence to many aspects of our industry. While the impact of economic growth is felt most directly at the individual household and business level, it is not possible to build a model which takes every one of these into account. As such, higher level measures of economic activity are used where measures of current activity and forecasts are available. Gross State Product (GSP) projections are a key driver to many of our forecasting models.

The Queensland Treasury released its 2022/23 State Budget in late June 2022. The COVID-19 pandemic had hit the state economy hard in the 2019/20 financial year, which resulted the Gross State Product (GSP) falling by 0.6%. However, the aggregate economic activity recovered 2.0% in the 2020/21 year, contributed by the substantial income support and stimulus provided across all levels of government, plus the substantial relaxation of restrictions and vaccine rollout. As a result, the Queensland economy and its local labour market have outperformed the rest of the nation over the same period. Despite the Omicron outbreaks in early 2022, coupled with the floods in February/March 2022, (estimated to be around \$1 billion, or ¼ percentage point of GSP), Queensland's domestic

economic activity, according to Queensland Treasury, still rose in the March-22 quarter, and was 7.8% higher than its pre-pandemic level.

Although Queensland recently experienced subdued overseas migration growth, the state has attracted interstate migrants to Queensland during the pandemic, which helped support overall population growth and activity. It is anticipated that the 2022/23 budget will help further enhance employment opportunities across Queensland, foster private sector investment and growth, and deliver record levels of infrastructure investment. This includes a \$59.1 billion infrastructure investment program over the next 4 years to 2025/26 to enhance the state's productive capacity. The Budget also provides \$6.8 billion in concessions (including subsidies, discounts and rebates) to individuals and families to ease cost of living pressures and reduce costs for business. Queensland Treasury predicts the state economy will grow by 3.0% in 2021/22 (slightly below the 3¼ % when the 2021/22 budget update was released) before slowing to 2¾ % over the years to 2025/26. Meanwhile, the labour market continues to remain robust. After falling to 4½ % in 2021/22, the state's unemployment rate is forecast to sit low across the years to 2025/26, between 4 and 4¼ %, as sustained employment growth and a pick-up in wages growth keep the participation rate elevated.

4.1.2 Solar PV

Solar PV has a significant load impact on our network, typically affecting the energy forecast outlook. The impact of solar PV is based on profiles which have been constructed to predict generation (and export) for rooftop systems for all forecast scenarios. In 2022, Energy Queensland had engaged ENEA Consulting to provide a Distributed Energy Resource (DER; which includes solar PV, Electric Vehicles and Energy Storage Systems) forecast for both Energex and Ergon Energy networks respectively.

A 0.5% per-annum degradation factor is used for solar PV systems. Small systems are designed to generate energy for the home with excess energy exported. Commercial-scale installations are larger and may or may not export to the grid. Utility-scale solar farms are designed to export.

Figure 6 illustrates the impact that solar PV has on the Energex summer system peak demand. Energex Summer system peak MW demand hit a historical high of 5,289MW between 2:30 and 3:00 pm on 2nd of February 2022 as the temperatures at Amberley hits a maximum of 33.4 degrees Celsius. It is estimated that solar PV reduced the peak by around 486MW at this time.

Figure 6 – System Demand – Solar PV Impact, 2 February 2022

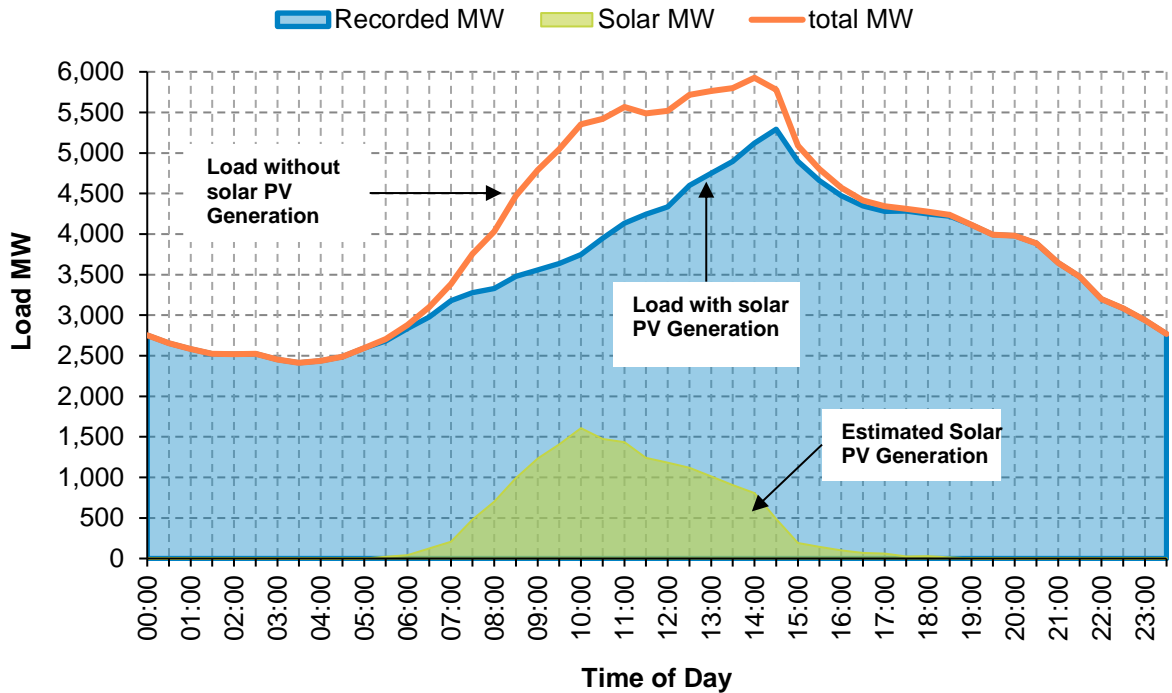

Solar PV’s impact on system peak demand is modelled separately by estimating and removing its historical impact, forecasting its future impact, and re-incorporating it into the overall system forecast.

Historically, temperature was the major variable on peak demand (after systematic factors such as time of day and day of year). However, the scale of solar PV generation means that cloud cover can create variations in generation output (thereby changing the source of supply to Powerlink) greater than what would be seen from temperature changes.

4.1.3 Electric Vehicles and Energy (battery) Storage

Mainstream uptake of electric vehicles (EVs) and Plug-in Hybrid electric vehicles (PHEVs) will increase energy and demand forecasts over the forecast horizon. The uptake rate of EVs and PHEVs has historically not been high due to a combination of factors including the high initial cost and low availability of various vehicle types. However, it is anticipated that EV is likely to have a significant increase through time with as more various vehicle types are on offer in the market and the EV cost creeping closer to price parity with its Internal Combustible Engine (ICE) counterpart. Therefore, the impact factored into the system demand forecast has been relatively small in the earlier years of the forecast but increases over time with the growing population of vehicles. Nonetheless, it is expected that a major part of the uptake of EV will be in the South East Queensland (SEQ).

Customer interest in energy storage systems (batteries of various kinds) continues to increase with the number of known energy storage systems in the Energex network being approximately 6,800 as of June 2022.

Energex’s forecasting model is based on an average typical hot summer day demand profile for residential and business customers, with the marginal impact of EVs, batteries and solar PV

incorporated into that profile. The impact of energy storage on the customer's energy consumption profile is 'behind the meter' which means that it cannot be directly measured.

4.1.4 Temperature Sensitive Load

Temperature sensitive loads such as air-conditioning and refrigeration are major drivers of peak demand load on the network. The most extreme loads seen on the network over a year can be driven by a combination of hot (and usually humid) weather conditions during times of high industrial and commercial activity (the scale of solar PV generation now creates other possibilities for extreme loads – see above). At the system level, the modelling process has continued to be refined over the years, with population replacing air-conditioning as a driver as it is better able to represent the impact of broader range of electrical appliances during the extreme conditions. Several weather stations are required to capture the variability of weather conditions across the network.

The process also requires a long history of quality weather data eliminating many data anomalies. Weather data from the following stations has been sourced from the Bureau of Meteorology (BOM), based on their representativeness of the weather in key population regions, and the quality of their extended weather history

- Amberley
- Archerfield
- Brisbane Airport
- Coolangatta
- Maroochydore.

Only a small proportion of observations were missing and were either estimated or substituted with data from nearby stations. The zone substation forecasting methodology also utilises weather data, with a process to identify the most relevant weather station to relate to a zone substation's load. Further details of the substation forecasting process are detailed below.

4.2 Substation and Feeder Maximum Demand Forecasts

The forecasting process provides the ability to predict where extra capacity is needed to meet growing demand, or new assets are required in developing areas. Energex reviews and updates its temperature-corrected, system, summer peak demand forecasts after each summer season and each new forecast is used to identify emerging network limitations in the sub-transmission and distribution networks. The bottom-up substation peak demand forecast is reconciled with the system level peak demand forecast, after allowances for network losses and diversity of peak loads. This process accounts for drivers which only become significant at the higher points of aggregation (e.g. economic and demographic factors), while also enabling investment decisions to be based on local factors. Hence, individual substation and feeder maximum demand forecasts are prepared to analyse and address limitations for prudent investment decisions.

The take-up of solar PV is continuing as electricity prices rise and the cost of solar PV falls, and the emerging influence of electric vehicles and battery storage systems has been incorporated at the system and substation levels of forecasting.

Balanced against this general customer trend, the forecasts produced post-summer 2021-22 have provided a range of demand growth rates, with many established areas remaining static while other areas like the northern Gold Coast, and the southern Sunshine Coast growing strongly. The forecasts are used to identify network limitations and to investigate the most cost-effective solutions which may include increased capacity, load transfers or demand management alternatives.

While growth in demand continues to increase at around 1.3% at the system level, there can be significant growth at a localised substation level. In the 2022-27 period, the percentage compound growth rates of zone substations were as follows:

- 52% of substations have an annual compound growth rate at or below 0%
- 33% have an average annual compound growth rate between 0% and 2%.
- 9% have an average annual compound growth rate between 2% and 5%
- 6% of zone substations have an annual compound growth rate exceeding 5%.

Demand management initiatives have impacted on peak loads at a number of zone substations. The initiatives include broad application of air-conditioning control, pool pump control and hot water control capability. Demand management is also being targeted at substations with capacity limitations in an effort to defer capital expenditure. The approach used is to target commercial and industrial customers with incentives to reduce peak demand through load shift, generation and call off load agreements. The resulting reductions are captured in the Substation Investment Forecasting Tool (SIFT) and in the ten-year peak demand forecasts.

The ten-year substation peak demand forecasts are prepared at the end of summer and are produced within SIFT. To enable appropriate technical evaluation of network limitations, these forecasts are completed for both existing and proposed substations. The forecasts are developed using data from internal sources as well as the Australian Bureau of Statistics (ABS), Australian Energy Market Operator (AEMO) and the Queensland Government. Economic and demographic influences are incorporated via the system demand forecasts. Independently produced forecasts for economic variables and photovoltaic installations, electric vehicles and battery storage systems uptake are also sourced from Deloitte's and the ENEA Consulting respectively.

Output from solar PV is generally coincident with Commercial and Industrial (C&I) peak demands, and there has been a significant uptake in PV for C&I premises. While this will provide benefits for those parts of the network which peak during times of significant PV generation, there are many other areas of the network which peak later in the afternoon/evening, where the impact of PV generation on the peak may either be limited or non-existent.

4.2.1 Zone Substation Forecasting Methodology

Energex employs a bottom-up approach, reconciled to a top-down evaluation, to develop the ten-year zone substation peak demand forecasts. Validated historical peak demands and expected load growth based on demographic and Distributed Energy Resource factors (DER – solar PV generation, Electric Vehicles, and un-aggregated battery energy storage capacity), which are used as data inputs into the forecasting model. The planning team provides local insights where relevant, as well as project, block load and load transfer information.

The peak demand forecasts are produced for:

- The 50 and 10 Probability of Exceedance (PoE) levels
- Each zone substation

- Summer and Winter
- Base, Low and High scenarios.

Zone substation forecasts are based on a probabilistic approach using a multiple regression estimation methodology. This approach has the advantage of incorporating a range of variability into the predictions.

A Monte Carlo simulation using BOM daily minimum and maximum temperature history is used to calculate the 10 PoE and 50 PoE maximum demands for each zone substation. Growth rates are then calculated using a separate model for summer and winter. Growth rates, load transfers and new major customer loads are then incorporated into the future load at each zone substation.

The zone substation forecasts are successively aggregated up to the bulk supply, and transmission connection points, to create forecasts at those levels – after taking diversity and losses into account. This aggregated forecast is then reconciled with the independent system demand forecast and adjusted as required.

The process sequence used to develop the ten-year substation demand forecast is briefly described as follows:

- Validated uncompensated substation peak demands are determined for the most recent summer period
- These loads are then associated with minimum and maximum temperatures at the relevant weather stations, to calculate the substation's temperature demand relationship
- Many industrial substations tend not to have much temperature sensitivity, as their load can vary due to a range of other factors. As a result, these 50 PoE and 10 PoE values tend to be based on sets of business rules chosen to reflect these expected load variations
- Previous substation peak demand forecasts are reviewed against temperature-adjusted results as part of a process looking for the causes behind individual variations
- Starting values for apparent power (MVA), real power (MW) and reactive power (MVA_r) are calculated for the key benchmarks of "summer day", "summer night", "winter day", and "winter night"
- The predicted impact of solar PV, battery storage, and plug-in EVs are incorporated into year-on-year peak demand growth rates derived from the customer load profiles and population forecasts
- The size and timing of block loads, transfers and projects are reviewed and validated with Grid Planning and Network Management before inclusion in the forecast
- The different elements of the forecast - growth rates, block loads, transfers are combined and applied to the starting values to produce a 10-year demand forecast
- The substation peak demand forecasts are reviewed extensively and compared with previous forecasts, with a focus on the relative error between recorded demand and the forecast for the most recent season. If necessary, adjustments are made to incorporate late information or factors not able to be included in the forecasting model
- Zone substation forecast peak demands are aggregated up to bulk supply substation, and transmission connection point, levels (after allowing for coincidence and losses) to produce forecasts at those network levels.

The zone substation forecast is "reconciled" against the system peak demand forecast to ensure that factors only clear at the distribution level (e.g. expected economic growth), are incorporated at the zone

substation level. This is done by calibrating relevant zone substations forecasts for the time of co-incident peak, which flows through to an adjustment of the zone substation's local peak.

Zone substation forecasts are based upon a number of inputs, including:

- Network topology (source: corporate equipment registers)
- Load history (source: corporate SCADA/metering database)
- Known future developments (new major customers, network augmentation, etc.) (source: Major Customer Group database)
- Customer categorisation (SIFT)
- Temperature-corrected start values (calculated by the FLARE forecasting model)
- Forecast growth rates for organic growth (calculated by the FLARE forecasting model)
- System maximum demand forecasts.

The impact of Embedded Generation on the Energex forecasted peak and minimum demand are estimated for each zone substation using the solar PV and Battery Energy Storage Systems uptake forecast and their corresponding demand load profiles. This is based on the medium Distributed Energy Resource (DER) uptake scenario for solar PV and battery storage systems forecast, sourced by ENEA Consulting for all zone substations. The forecasted Embedded Generation for each zone substation is disaggregated from the systems level forecast based on the historical DER penetration rates across each individual zone substation in the forecast. The demand load profiles for solar PV are then estimated by modelling the historical relation between available solar PV inverter capacity and the measured solar irradiance hourly profiles based on a typical peak demand and minimum demand day.

Electric vehicles (EV) are not considered as part of the embedded generating unit category as the Vehicle to Grid (V2G) technology considered to be at its infant stage, and the DER forecast suggests that EV would have an impact on the network from a peak demand perspective rather than generation.

The forecast use of distribution services (export) by embedded generating units are estimated from each zone substation's load profile forecast. The uptake of solar PV systems is pushing the middle of the day load towards zero and causing reverse power flow in some parts of the network. This reverse power flow has been utilised to represent the zone substation export caused by the Embedded Generation. The Embedded Generation export for each zone substation is forecasted on both peak and minimum demand events using the medium DER uptake scenario forecast and demand profiles.

4.2.2 Sub-transmission 110kV and 132kV Feeder Forecasting Methodology

A simulation tool is used to model the 110kV and 132kV transmission network. The software was selected to align with tools used by Powerlink and the Australian Energy Market Operator (AEMO). Powerlink provides a base model on an annual basis. This base model is then refined to incorporate future network project components. Two network loading scenarios are considered; native load and load with DER and generation integration. For the load scenario peak forecast loads at each bulk supply, zone substation and connection point are loaded into the model from SIFT. For the DER scenario, the DER forecast is determined and integrated into the SIFT loading and large generating systems are enabled.

Twenty models are created using this simulation tool, with each model representing the forecast for a particular season in a particular year. The models have five years of summer day 50 PoE and 10 PoE data and five years of winter night 50 PoE and 10 PoE data.

4.2.3 Sub-transmission 33kV Feeder Forecasting Methodology

Forecasts for sub-transmission feeders are produced for a five-year window aligning with the capital works program. Sub-transmission forecasts identify the anticipated maximum loadings on each of the sub-transmission feeders in the network under a normal network configuration.

Modelling and simulation is used to produce forecasts for the sub-transmission feeders. The traditional forecasting approach of linear regression of the historical loads at substations is not applicable since it does not accommodate the intra-day variation. The modelling approach enables identification of the loading at different times of day to equate to the line rating in that period. A software tool models the 33kV sub-transmission network. The simulation tool has built-in support for network development which provides a variable simulation timeline that allows the modelling of future load and projects into a single model.

Simulation models are created using existing network data. Future projects are then modelled with timings and proposed network configurations based on future project proposals being included. Future projects are automatically activated depending on the network analysis dates selected. The forecast peak loads at each substation for all years within the planning period are uploaded into the model from the SIFT. Eight models are produced, each containing forecast load for the different seasons. These include summer day, summer night, winter day and winter night, combined with 10 PoE or 50 PoE peak load. This enables the identification of worst-case risk period for each season.

These models are replicated for two network load scenarios that have been considered, native load and loading with DER and generation integration. The native load scenario provides indication of areas of the network may require augmentation due to load, impacts of phenomenon like solar masking being considered. The DER and generation integration scenario highlight areas of the network that have high penetration of generation and capacity constraints or areas where capacity for Embedded Generation remains.

4.2.4 Distribution 11kV Feeder Forecasting Methodology

Distribution feeder forecast analyses carry additional complexities in comparison to sub-transmission feeder forecasting. This is mainly due to the more intensive network dynamics, impact of block loads, variety of loading and voltage profiles, lower power factors, peak loads occurring at different times/dates and the presence of phase imbalance. Also, the relationship between demand and average temperature is more sensitive at the distribution feeder level.

Forecasting of 11kV feeder loads is performed on a feeder-by-feeder basis. The demand forecast begins by identifying and removing any temporary (abnormal) loads and transfers and then establishing a feeder load starting load profile. For peak demand forecast the starting load profile is determined by undertaking bi-annual 50 PoE temperature-corrected load assessments (post-summer and post-winter). This involves the analysis of daily peak loads for day and night to identify the load expected at a 50 PoE temperature after . The minimum demand starting load profile is the demand load profile of last year's minimum demand day after upstream power flow load adjustment. The upstream load adjustment is necessary for feeders without bi-directional real power data. The load adjustment is a model that detects the periods of upstream power flow (reverse power flow) and flips the real power sign from positive to negative.

On the macro level, the forecasting drivers are similar to those related to substations, such as economic and population growth, consumer preferences, solar PV systems, battery storage systems, electric

vehicles, etc. Accordingly, a combination of trending of normalised historic load data and inputs including known future loads, economic growth, weather, local government development plans, etc. is used to arrive at load forecasts.

Using a statistical distribution, the 10 PoE load value is extrapolated by using 80% of the temperature sensitivity from the 50 PoE load assessment. The summer assessment covers the period of December-January-February, the winter assessment from June-July-August, and minimum demand assessment is based on calendar year. Growth rates are applied, and specific known block loads are added and events associated with approved projects are also incorporated (such as load transfers and increased ratings) to develop the feeder forecast. In addition, the 10 PoE load forecast is used for determining voltage limitations.

In summary, the sources used to generate distribution feeder forecasts are as follows:

- The historic maximum demand values, in order to determine historical demand growths. These historical maximum demands have been extracted from feeder metering and/or Supervisory Control and Data Acquisition (SCADA) systems and filtered/normalised to remove any abnormal switching events on the feeder network. Where metering/SCADA system data are not available, maximum demands are estimated using After Diversity Maximum Demand (ADMD) estimates or calculations using the feeder consumption and appropriate load factors
- The Queensland Government Statistician's Office spatial population projections, combined with Energex's customer number forecasts to determine customer growth rates
- The forecast for solar PV systems, battery storage and EV from ENEA Consulting scenario modelling DER forecast is used as one of the growth drivers at distribution feeder level
- The temperature data, used to model the impacts of weather on maximum demand, is supplied by Weather Zone, which sources its data from the Bureau of Meteorology. This is used to determine approximate 10 and 50 PoE load levels
- Further forecast information is obtained from discussions with current and future customers, local councils and government.

The impact of Embedded Generation growth on feeder peak and minimum demand are estimated using the same methodology as zone substation forecast (refer to Section 4.2.1)

Similar to the zone substation forecasting methodology under Section 4.2.1, the demand of Embedded Generation on the Energex forecasted peak and minimum demand are also modelled for each 11kV distribution feeder. The medium DER uptake scenario was used for solar PV and Battery Energy Storage Systems along with their corresponding demand load profiles. EVs are not considered as part of the embedded generating unit category as described in Section 4.2.1.

The forecasted Embedded Generation for each 11kV distribution feeder substation is disaggregated from the systems level forecast based on the historical DER penetration rates across each individual feeder. The demand load profiles for solar PV are then estimated by modelling the historical relation between available solar PV inverter capacity and the measured solar irradiance hourly profiles based on a typical peak demand and minimum demand day.

The forecast use of distribution services (export) by embedded generating units are estimated from each 11kV feeder distribution load profile forecast. The uptake of solar PV systems is pushing the middle of the day load towards zero and causing reverse power flow in some parts of the network. This reverse power flow has been utilised to represent the 11kV distribution feeder export caused by the Embedded

Generation. The Embedded Generation export for each distribution feeder is forecasted on both peak and minimum demand events using the medium DER uptake scenario forecast and demand profiles.

4.3 System Maximum Demand Forecast

Energex reviews and updates its ten-year 50 PoE and 10 PoE system summer peak demand forecasts after each summer season and each new forecast is used to identify emerging network limitations in the sub-transmission and distribution networks. For consistency and robustness, the substation peak demand forecast ('bottom-up') is reconciled with the system level peak demand forecast ('top-down'), after allowances for network losses and diversity of peak loads.

The 'top-down' forecast is an econometric ten-year system maximum demand forecast based on identified factors which affect the load at a system-wide level. Inputs for the system maximum demand forecast include:

- Economic growth through the Gross State Product (source: ABS website and forecasts by Deloitte)
- Temperature (source: BOM)
- Population (source: Deloitte)
- Solar PV generation (source: customer installation data and ENEA Consulting)
- Load history (source: corporate SCADA/metering database)
- Electric Vehicles (source: ENEA Consulting)
- Energy Storage (source: ENEA Consulting).

The 'bottom-up' forecast consists of a ten-year maximum demand forecast for all zone substations (also described as 'spatial forecasts') which are aggregated to a system total and reconciled to the econometrically derived system maximum demand. These zone substation forecasts are also aggregated to produce forecasts for bulk supply substations and transmission connection points. Further details are available in the Zone Substation Forecasting Methodology section.

In recent years, there has been considerable volatility in Queensland economic conditions, weather patterns and customer behaviour which have all affected total system peak demand. The influence of Queensland's moderate economic growth has had a moderating impact on the peak demand growth through most of the state. At the same time, weather patterns have moved from extreme drought in 2009, to flooding and heavy rain in recent years, to extended hot conditions over the past several summer periods. Summer conditions in recent years have produced new record high maximum demand.

4.3.1 System Demand Forecast Methodology

The methodology used to develop the system maximum demand forecast as recommended by consultants ACIL Tasman is as follows:

- Develop a multiple regression equation for the relationship between demand and GSP, weighted maximum temperature, weighted minimum temperature, three continuous hot days, weekends, Fridays and Christmas period and November to March temperature data that excludes days with average temperature at selected weather stations that are below the set levels (for example, weighted mean temperatures < 22°C and daily maximum temperature <

28.5°C). Three weather stations were incorporated into the model through a weighting system to try to capture the influence of the sea breeze on peak demand. Statistical testing is applied to the model before its application to ensure that there is minimal bias in the model

- An error factor is applied to the simulated demands based on a random distribution of the multiple regression standard error. This process attempts to define the peak demand rather than the regression average demand.
- A Monte Carlo process is then used to simulate a distribution of summer maximum demands using the latest 30 years of summer temperatures plus an independent ten-year GSP forecast. That distribution of demands is used to identify the initial 50 PoE and 10 PoE maximum demands.
- Those initial 50 PoE and 10 PoE values are then calibrated to account for demand management initiatives, solar PV, battery storage and the expected impact of electric vehicles. That is, the impact of DER is included via a post-model adjustment.

Important measures used in this methodology consist of the following:

- The actual maximum coincident (or Peak) demand, is the highest rate of supply over a 30 minute interval over a season (summer or winter) during a year
- A 50 PoE demand/level - is the calculated estimate of a maximum demand that would be expected for an average season for that year. The 10 PoE demand/level is the maximum demand that could be expected in an extreme season (a 1 in 10-year event)
- The 50 and 10 PoE estimates of demand, enable growth estimates to be calculated without being distorted by variations in seasonal intensity. As such, the industry considers them the most accurate and reliable indicator of future demand in the network.

4.3.2 Medium, high and low case scenarios

Peak demand is impacted significantly by weather and economic conditions, population growth and technology adoption. Base, high and low scenarios are created by combinations of the economic forecasts, Monte Carlo simulations on summer daily temperatures and the DER post-model adjustments. While higher or lower levels of the individual DER components can vary positively or negatively with peak demand, the DER factors are incorporated as an aggregate impact with the DER scenario aligning with the corresponding peak demand scenario. The results of the forecasts are compared in Figure 7. Demand management load reductions are included in the forecast. The scenario's presented are based partly on DER scenarios developed by ENEA Consulting. The medium, high and low cases and are designed to capture future uncertainties and risks.

Figure 7 – Three Scenarios of EGX Summer Peak MW Forecasts @ 50 PoE Level

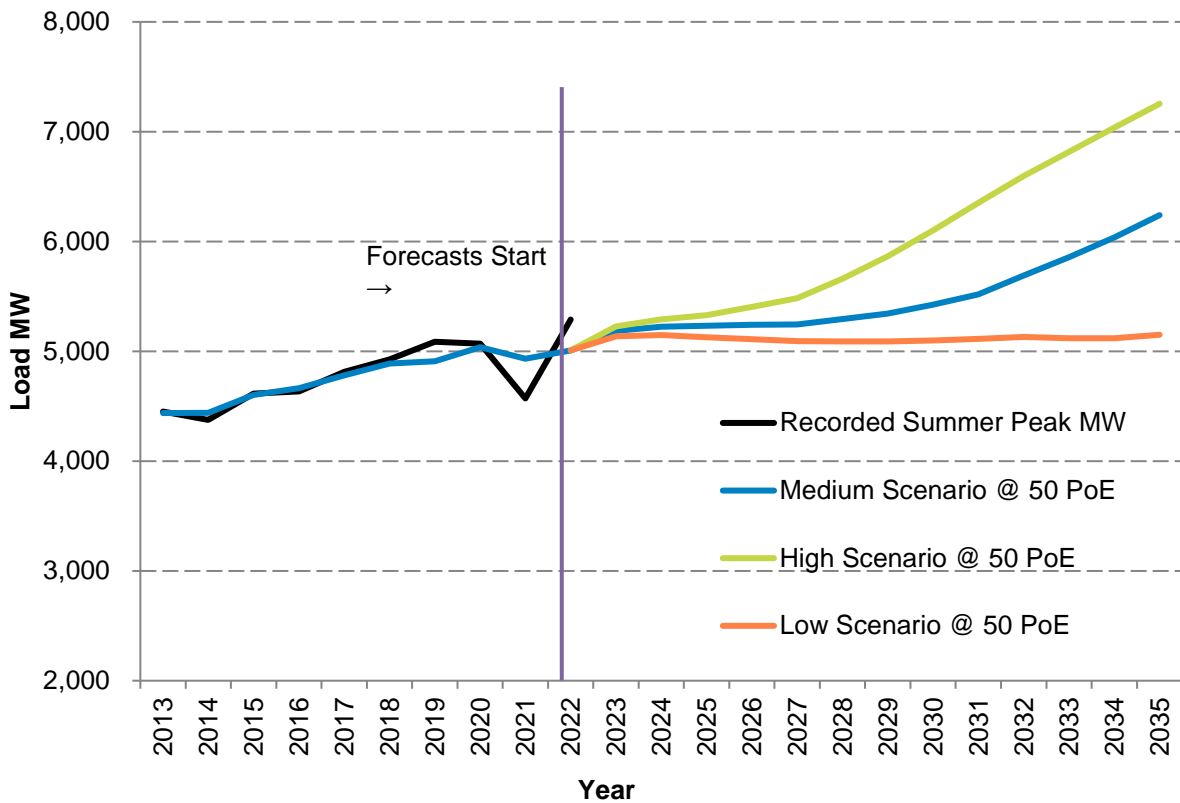

Energex Summer system peak MW demand hit a historical high of 5,289MW over 2:30 ~ 3:00 pm on 2nd-Feb-2022 as the temperatures at Amberley hit a maximum of 33.4 degrees Celsius. This peak is 15.7% higher than the previous year due to the combination seasonal intensity varying significantly between last year and this year, and the government response to COVID-19 boosting the economy.

This year's peak is unusual not only in terms of the increase over the previous year, but also in terms of the time of peak (mid-afternoon against the normal time between 4:30 ~ 5:30 pm) and is considered to be close to a 10 POE event. The main contributor came from the weather – a combination of a hot & humid day followed by the pre-storm cloud cover – lowering the PV generation considerably (thus triggering more MW requirement from the networks). The latest forecast projects that the 50 POE peak demand will increase from 5,008MW in 2021/22 to 5,689MW in 2031/32, as the negative impacts of COVID-19 fade away and the upbeat trend in DER (especially its EV component) accelerates. This equates to the 1.3% compounded annual growth.

Investment in new infrastructure is still required as additional areas are connected and the number of connected customers continues to grow. However, the visibility of this growth is being masked by changes in the existing base of customers via increasing energy efficiency, solar PV installations and demographic changes that are happening at lower levels of the network. Table 2 summarises the actual and temperature-corrected (50% PoE) demands based on a range of weather station temperatures and associated maximum demand changes over the past five years. Along with the actuals, the summer and winter 50 PoE values have been calculated to illustrate the underlying network growth. However, as these figures are derived from each year's model, yearly comparisons of the temperature corrected demands should only be made using a series of numbers from the same model.

Yearly peak demands vary due to changes in key drivers including (but not limited to) summer temperatures, cloud cover, the behaviour of customers etc. Extreme seasons provide valuable insights into the potential future loads for both average and extreme seasons.

Table 2 – Actual Maximum Demand Growth – South-East Qld

Demand	2017/18	2018-19	2019-20	2020-21	2021-22
Summer Actual (MW) ¹	4,926	5,086	5,069	4,570	5,289
Growth (%)	2.3%	3.3%	-0.4%	-9.8%	15.7%
Summer 50% PoE (MW)	4,888	4,909	5,038	4,934	5,008
Growth (%)	2.3%	0.4%	2.6%	-2.1%	1.5%
	2017	2018	2019	2020	2021
Winter Actual (MW)	3,458	3,643	3,748	3,878	3,890
Growth (%)	-5.4%	5.3%	2.9%	3.5%	0.3%
Winter 50% PoE (MW)	3,520	3,675	3,763	3,861	3,851
Growth (%)	-0.7%	4.4%	2.4%	2.6%	-0.2%

¹ The Summer Actual Demand has been adjusted to take account of Embedded Generation operating at the time of System Peak Demand.

Table 3 lists the maximum demand forecasts over the next five years. The summer peak demand is forecast to increase to 5,185MW by 2022/23 in line with our expectation for an average season. Summer peak demands over the 2021/22 – 2031/32 period are forecast to increase with an annual average growth rate of 1.3%, reaching 5,689MW in 2031/32.

The forecast of solar PV generation, EVs and Battery storage systems at the time of summer peak demand is shown in Table 4. Analysis indicates that the continued growth of solar PV will reduce loads during daylight hours, causing system peak demands to occur slightly later towards the end of the forecast horizon. Energex has also developed a model for the adoption of battery storage with the impact on peak demand being driven by large solar PV customers with little or no feed-in tariffs (FIT). There are an increasing number of solar PV customers with systems that provide more electricity than they can use internally during the day but are not receiving the 44 cents per kWh FIT. These customers are likely to be very interested in battery storage and are seen to be the early adopters. The projected impact of battery storage systems on system peak demand is shown in Table 4. The model assumes that battery storage will primarily be charged by solar PV and discharged over the late afternoon and early evening period between 4pm and 8pm with an initially small but growing impact on the system peak demand.

Table 3 – Maximum Demand Forecast (MW) – South-East Qld

Forecast ^{1, 2}	2022-23	2023-24	2024-25	2025-26	2026-27
Summer (50% PoE)	5,185	5,223	5,233	5,242	5,245
Growth (%)	-	0.7%	0.2%	0.2%	0.1%
Summer (10% PoE)	5,535	5,576	5,589	5,598	5,598
Growth (%)	-	0.7%	0.2%	0.2%	0.0%
	2022	2023	2024	2025	2026
Winter (50% PoE)	3,878	3,943	3,965	4,026	4,051
Growth (%)	-	1.7%	0.6%	1.5%	0.6%
Winter (10% PoE)	4,022	4,094	4,121	4,189	4,226
Growth (%)	-	1.8%	0.7%	1.7%	0.9%

¹ The five-year demand forecast was developed using three weather station weighted data as recommended by ACIL Allen.

² The demand forecasts include the impact of the forecast economic growth as assessed in May 2022.

Table 4 – Contribution of Solar PV, EVs and Battery Storage Systems to Summer System Peak Demand

Impact on Summer System Peak Demand (MW)	2023	2024	2025	2026	2027	2028	2029	2030	2031	2032
Solar PV Capacity	-184	-208	-232	-255	-149	-159	-168	-176	-183	-7
Electric Vehicle Load	2	2	3	4	16	25	45	78	124	452
Battery Storage Systems Load	-9	-13	-18	-25	-41	-53	-62	-69	-76	-80

Chapter 5

Network Planning Framework

- Background
- Planning Methodology
- Key Drivers for Augmentation
- Network Planning Criteria
- Plant Thermal Rating
- Voltage Limits
- Fault Level
- Planning of Customer Connections
- Major Customer Connections, including Embedded Generators
- Joint Planning

5 Network Planning Framework

5.1 Background

Energex's Network planning framework aims to provide a balance between the customers' need for a safe, secure, reliable and high quality electricity supply with the customers' desire for a minimal service cost. A key part of the network planning process is to optimise the economic benefits of network augmentation and renewal facilitating "non-traditional" options beyond the boundaries of the network, such as demand management, Embedded Generation solutions and other approaches. Addressing of network limitations and risks is at the core of the planning framework to ensure the solutions are optimal to meet current and future requirements.

The selection of the optimal network and business solution is achieved by:

- Determining and critically assessing key network limitations
- Developing and evaluating a broad range of network and non network solutions
- Seeking to integrate and optimise outcomes using a variety of planning inputs
- Staging of project phases to ensure prudent expenditure.

This section outlines the network planning criteria, process and framework that underpins our network planning approach. There are several definitions essential to the understanding of Energex's network planning philosophy. Reliability of supply is the probability of a system performing adequately under normal operating conditions. A reliable network that meets service obligations is an important objective and is dependent on two measures - adequacy and security.

Adequacy is the capacity of the network, and its components, to supply the electricity demand in accordance to acceptable quality of supply standards. It includes requirements that network elements operate within their thermal ratings, whilst maintaining voltage within statutory limits.

Security is the ability of the network to cope with faults on major plant and equipment without the uncontrolled and prolonged loss of load. A secure network often factors in redundancy of major plant and equipment to tolerate the loss of single elements of the system. Energex plans network investment to meet its Safety Net targets as listed in Table 5. The standard allows Energex to make use of available transfers and non-network capabilities and is inherent in the assessment of security standard compliance. Energex's planning standard for sub-transmission networks takes into account the Value of Customer Reliability (VCR) and obligated Safety Net targets, with the later embedded in our Distribution Authority, to alleviate the adverse outcomes of low probability, high consequence events. In 2021 Energex began to incorporate a risk quantification framework into its planning methodology, along with incorporating the AER's Customer Export Curtailment Value (CECV) framework.

The security standard takes into account the following key factors:

- Feeders and substations are assigned a category according to the criteria defined in the Distribution Authority (CBD, Urban, Rural) and the appropriate Safety Net target is assigned to relevant network types
- Plant and power line thermal ratings depend upon their ability to discharge heat and are therefore appreciably affected by the weather, including ambient temperature and, in the case of overhead lines wind speed
- A range of actions to defer or avoid investments, such as non-network solutions, automated, remote and manual load transfer schemes and the deployment of a mobile substation and/or mobile generation, increase utilisation of network assets
- Value of Customer Reliability is utilised to justify and optimise investment timing
- Specific security requirements of large customer connections that are stipulated under the relevant connection agreements.

The Energex distribution network is also required to maintain voltage levels within legislative requirements and ensure safe operation under fault conditions. These requirements are addressed during the annual planning review. In general, the factors that impact demand growth, plant thermal rating limitations, load transfer capabilities and asset condition which, combined with planning and security criteria, risks and security of supply, network performances, non-traditional solutions and overall economics of potential investment are embedded in network planning process.

5.2 Planning Methodology

5.2.1 Strategic Planning

Energex's planning process involves production of long-term strategic network development plans. These plans assess the electricity supply infrastructure requirements for defined areas based on the most probable forecast load growth projections. Scenario forecasting is used to develop alternative network development plans for a range of economic forecasts, population growths, and new technologies (such as PVs, electric vehicles and battery energy storage systems). Demographic studies based on local government plans are carried out to help indicate the likely long-term demand for electricity across a development area. These include scenario modelling to test various outcomes, such as high or low customer response to demand management, tariff reform and energy efficiency initiatives.

The strategic planning process is an iterative and analytical process that provides an overall direction for the network development of a region. The purpose of strategic network development plans is to ensure the prudent management and investment for network infrastructure in both the short and long term, and to coordinate developments to address constraints and meet utilisation targets.

Strategic network development plans detail the results of the long-term strategic forecasting and network planning studies that produce the set of recommendations for proposed works over the study period for a specific supply area. This includes:

- Details of all proposed works over the study period, including variations and dependence on different trigger factors
- Recommendations for easement and site acquisitions required in advance of any proposed works, including variations and dependence on trigger factors.

The long-term nature of strategic planning means that there is significant uncertainty around the estimations of ultimate load growth (worst case scenario) and exact location of load. The output of the strategic planning process gives direction to the medium and long-term recommendations, while allowing strategic site and easement acquisition and approvals to proceed. Specific outcomes of strategic network development plans may be used to identify areas where non-network solutions have potential to defer or avoid network augmentation. These are ongoing and reviewed as required.

5.2.2 Detailed Planning Studies

In order to address the forecast network limitations and ensure ongoing safe and reliable operation of the network, network augmentation and replacement project options for a specific site/network are identified in the detailed planning studies. With a typical outlook of 10 years, this information informs regulatory processes through Joint Planning, the DAPR, the revenue submission and regulatory information notices. This information also informs financial forecasting, easement and future substation acquisition activities.

These planning studies are conducted at the sub-transmission and distribution level to consolidate and assess any other factors that may have a material impact on the studied network. This usually includes an assessment of:

- Non-network alternatives
- Fault levels
- Voltage levels
- Security of supply requirements
- Quality of supply and network reliability considerations
- Asset condition and renewal
- Customer connections activity
- Local, state and federal government decisions and directions.

Based on the network requirement dates, and/or the target completion dates, each capital project is brought into the PoW and then investigated in detail for the preparation of comprehensive business cases, regulatory documents and project approval reports in accordance with the NER and Energex standard practices, procedures and policies. This process ensures the current and future adequacy of the Energex sub-transmission and distribution networks. The information informs regulatory processes through the RIT-D, joint planning and demand side engagement activities.

The planning process for a network segment involves the following major steps in a typical routine planning cycle:

- Identify network risks/limitations in the system
- Validate load forecasts
- Evaluate the capability of the existing system
- Formulate network options to address these risks/limitations and identify any feasible non-network solutions from prospective proponents
- Compare options on the basis of technical and economic considerations
- Select a preferred development option
- Undertake regulatory public consultations for projects as required, and carry out detailed evaluation upon receipt of any alternative solutions from the registered participants/ proponents
- Initiate action to implement the preferred scheme through formal project approvals.

Project planning and approvals are currently carried out in accordance with the RIT-D requirements applicable for the projects having credible options valued at more than \$6 million.

5.3 Key Drivers for Augmentation

Network augmentation can be the result of changes in customer requirements, load growth, aged assets, upstream augmentation works, changes in network reconfiguration or major customer works that impact the shared network.

There are four general types of customer activity that can cause constraints in Energex's distribution system and prompt the need to invest:

1. Organic growth that occurs when existing customers increase or change the profile of their electricity usage in a part of the network, or across the network. For example, the increase in air conditioner installations in the 1990's or the installation of solar systems in recent years
2. Increases in the number of residential or small commercial customers in a part of the network
3. Block loads connecting to a part of the network, such as new large commercial or industrial customers
4. Changes/installation of medium to large scale embedded generators and/or storage technology.

Without network augmentation or non network investment, customers' increased demand can result in load demand exceeding planning limits (including component capacity/ratings, voltage regulation limitations and protection limit encroachment) and/or the breach of network security criteria.

Augmentation works within our network can also be driven by Powerlink, as the Transmission Network Service Provider (TNSP). Work on Powerlink's network may also require compulsory activity within our network in order to ensure the transmission network integrity and capacity can be delivered to the distribution network. Such activity could be the result of increased fault levels or plant rating limitations. These types of augmentation activities are analysed and reviewed as part of the Joint Planning process conducted between Energex and Powerlink (or other DNSPs) as required by the NER.

Demand Forecast

Accurate demand forecasting is essential to the planning and development of the electricity supply network. Energex has adopted a detailed and mathematically rigorous approach to forecasting of electricity demand, and customer numbers. These methods are described in detail in Chapter 4. Energex also undertakes regular audits and reviews by external forecasting specialists on its forecasting models. Demand forecasts are not only undertaken at the system level but are also calculated for all substations and feeders for the forward planning period. These forecasts are used to identify emerging network limitations and risks that need to be addressed by either network or non-network based solutions. These forecasts are then used as an input to determine the timing and scope of capital expenditure, or the timing required for demand reduction strategies to be established, or risk management plans to be put in place.

Asset Age and Condition

Energex has an extensive Asset Lifecycle Management program which is discussed in detail in Chapter 8. An important output of this program is the identification of equipment which is nearing end of life due to condition and/or age. In the case of major plant items, such as power transformers, high voltage circuit breakers etc. the end of life information is considered within the planning process as a “network limitation,” just like any other (capacity) network limitation. Hence, the options to either refurbish, replace, or retire the plant item is considered in the context of network safety, security, and reliability standards.

5.4 Network Planning Criteria

Network planning criteria is a set of rules that guide how future network risk is to be managed or planned for, and under what conditions network augmentation or other related expenditure (such as demand management) should be undertaken.

There are two widely recognised methodologies for the development of planning criteria for power systems:

- Deterministic approaches (e.g. N-1, N-2, etc.)
- Probabilistic (risk-based) approaches.

Energex is required under Distribution Authority No. D07/98 to adhere to the deterministic planning approach where full consideration is given to the network risk at each location, including operational capability, plant condition and network meshing with load transfers.

The criteria gives consideration to many factors including the capability of the existing network asset, the regulated supply standards (such as voltage, quality, reliability, etc.), the regulatory framework around investment decision making, the magnitude and type of load at risk, outage response capability and good electricity industry practice. Consideration is given to the complexity of the planning process versus the level of risk, allowing for simpler criteria to apply where lower risks exist and where the cost of potential investments is smaller.

While the probabilistic planning criteria is far more complex in application, the criteria increases the focus on customer service levels:

- **Customer Value Investment** predominantly driven by the benefits gained from a reduction in the duration of unplanned outages (i.e. Value of Customer Reliability (VCR)), but also including (where applicable) other classes of market benefits
- **Mandatory Investment:** this includes the regulated standards for the quality of supply as per the NER, and the Minimum Service Standards (MSS) and Safety Net requirements in the Distribution Authority and any other regulatory obligations.

For increased confidence on the network investments, proposed investments that are not mandatory must have a positive Net Present Value (NPV) when all significant costs and benefits are accounted for, over a reasonable evaluation period (usually 20 years). While mandatory investments may not be NPV positive different options and benefits are still considered for each project with the lowest present cost option being selected for progression. All investments are risk ranked and prioritised for consideration against Energex's budget and resource levels, with some network risks managed operationally.

5.4.1 Value of Customer Reliability

In December 2019, the AER published the results of an investigation into the value that NEM customers place upon reliability.

According to the AER Review, the VCR:

“seek to reflect the value different types of customers place on reliable electricity under different conditions. As such, VCRs are useful inputs in regulatory and network investment decision-making to factor in competing tensions of reliability and affordability. Importantly, VCR is not a single number but a collection of values across residential and business customer types, which need to be selectively applied depending on the context in which they are being used “

Components of VCR calculation include:

- Energy at Risk (EaR): the average amount of energy that would be unserved following a contingency event, having regard to levels of redundancy, alternative supply options, operational response and repair time
- Probability of the Contingency (PoC) occurring in a given year at a time when there is energy at risk
- Network losses between the metering point and the customer
- Customer mix, by energy consumption across various customer sectors.

The first three factors are combined to calculate the 'annualised probability-weighted Unserved Energy (USE)' in MWh. The last factor, customer mix, is combined with the AER VCR tables to calculate the 'energy-weighted locational VCR' (in \$/MWh). Finally, the two are multiplied to calculate the annual economic cost of unserved energy (VCR) associated with the given contingency (or contingencies). By also considering load growth and (for example) plant ageing, estimates of the annual VCR are calculated across the evaluation period (usually 60 years).

Changes in VCR associated with a particular project (or option) represent a benefit (if positive), or a cost (if otherwise) that is used as a benchmark to assess proposed solutions. To be comparable, proposed solutions are required to be expressed in terms of annualised costs or annuities. By balancing the VCR and the cost of supply, a more efficient service can be provided to our customers.

5.4.2 Safety Net

While the VCR approach described above provides an effective mechanism for keeping costs low while managing most network risk; high-consequence-low-probability events could still cause significant disruption to supply with potential customer hardship and/or significant community or economic disruption.

The Safety Net requirements outlined in the Distribution Authority address this issue by providing a set of “security criteria” that set an upper limit to the customer consequence (in terms of unsupplied load) for a credible contingency event in the Energex network as shown in Table 5 and Table 6. Energex is required to meet the restoration targets defined in Schedule 3 of Energex’s Distribution Authority “...to the extent reasonably practicable”.

This statement acknowledges that regardless of level of preparation, there will always be combinations of circumstances where it is impossible to meet the restoration targets at the time of an event, though these should be rare. For example, if it is unsafe to work on a line due to adverse weather conditions, though these should be rare. In addition, during the planning phase, where the risk of failing to meet the target timelines is identified as being of very low probability, investment to further mitigate the risk would generally not be recommended, as per industry best practice. This risk is also addressed with larger customers that enter into a negotiated connection contract with Energex, as the parties are able to agree upon the particular terms of the supply arrangement, including when and to what extent there may be restrictions on supply. Energex considers this approach strikes an appropriate balance in meeting the safety net targets while ensuring that investments in the network are prudent and efficient, and meets customer expectations of a secure, reliable and affordable supply.

The application of the Safety Net ensures that under system normal conditions the normal cyclic capacity of any network component must be greater than the forecast load (10 PoE). The capacity of the network is also assessed based on the failure of a single network component (transformers or power lines) against the 50 PoE forecast load. This enables the load at risk under system normal (LAR_n) and the load at risk for contingency conditions (LAR_c) to be assessed as key inputs to investment planning against Safety Net targets.

Load Transfer Capability

Energex’s Safety Net integrates the full use of load transfers between sub-transmission systems and zone substations. These use the sub-transmission or distribution feeder networks to reduce the impact of an outage in the event of a major plant failure. Load transfer capabilities for each zone substation are calculated using load flow studies, taking into account the thermal ratings and voltage stability of the network. For example, the load transfer capability at a substation level in an urban network is calculated based on 75% of the sum of all available transfers on each of the supplied distribution feeder. The 75% factor is applied to account for diversity and to provide a margin of error for unforeseen circumstances such as protection coverage. The transfer amount applies throughout the forward planning period. In addition, more detailed load transfer studies are incorporated during individual project planning phases. Where these assessments indicate that the network is not able to meet the required Safety Net, the resulting network limitation must be addressed to ensure that the Safety Net compliance is achieved.

Table 5 – Safety Net

Category	Safety Net Targets
High Security	<ul style="list-style-type: none"> Ensure that any single credible event does not result in a loss of customer supply.
CBD	<ul style="list-style-type: none"> Any interruption in customer supply resulting from an N-1 event at the sub-transmission level is restored within 1 minute.  <p>The diagram for CBD shows a load profile starting with an 'Initial Load' (green bar) up to a '50 PoE' (blue dashed line). At 'Fault at T=0', the load drops to zero for '1 min'. It then recovers to a 'Minimum Restored Load' (green bar) until the next '50 PoE'.</p>
Urban	<ul style="list-style-type: none"> no greater than 40MVA (16,000 customers) is without supply for more than 30 minutes; no greater than 12MVA (5,000 customers) is without supply for more than 3 hours; and no greater than 4MVA (1,600 customers) is without supply for more than 8 hours.  <p>The diagram for Urban shows a load profile starting with an 'Initial Load' (green bar) up to a '50 PoE' (blue dashed line). At 'Fault at T=0', the load drops to zero for '30 min' with a label 'Maximum 40MVA Interruption'. It then recovers to a lower level for '3 hrs' with a label 'Maximum 12MVA Interruption'. It recovers again for '8 hrs' with a label 'Maximum 4MVA Interruption'. Finally, it recovers to the 'Minimum Restored Load' (green bar) until the next '50 PoE'.</p>
Rural	<ul style="list-style-type: none"> no greater than 40MVA (16,000 customers) is without supply for more than 30 minutes; no greater than 15MVA (6,000 customers) is without supply for more than 4 hours; and no greater than 10MVA (4,000 customers) is without supply for more than 12 hours.  <p>The diagram for Rural shows a load profile starting with an 'Initial Load' (green bar) up to a '50 PoE' (blue dashed line). At 'Fault at T=0', the load drops to zero for '30 min' with a label 'Maximum 40MVA Interruption'. It then recovers to a lower level for '4 hrs' with a label 'Maximum 15MVA Interruption'. It recovers again for '12 hrs' with a label 'Maximum 10MVA Interruption'. Finally, it recovers to the 'Minimum Restored Load' (green bar) until the next '50 PoE'.</p>

Table 6 – Service Safety Net Targets

Feeder Type	Demand Range	Allowed Outage Duration to be Compliant
CBD	No outage Compliant	No outage Compliant
Urban – Following an N-1 event	>40MVA	No outage Compliant
	12 - 40MVA	30 minutes Compliant
	4 - 12MVA	3 hours Compliant
	<4MVA	8 hours Compliant
Short Rural – Following an N-1 event	>40MVA	No outage Compliant
	15 - 40MVA	30 minutes Compliant
	10 -15MVA	4 hours Compliant
	<10MVA	12 hours Complaint

Efficient investments under the Safety Net provisions will provide mitigation for credible contingencies that could otherwise result in outages longer than the Safety Net targets.

A Safety Net review of the network’s sub-transmission feeders with zone and bulk supply substations are performed annually to examine the network transfer capabilities, forecasts, substation asset ratings, bus section capabilities, network topologies and protection schemes. Further work is undertaken to ensure items within the operational response plans are outworked, this may include asset spares, location of specialist machinery, access conditions and skills of crews. Energex annually reviews the inventory of mobile substations, skid substations and mobile generation and site suitability, to apply injection, if required to meet Safety Net compliance.

Energex continues to review the changing state of the network for Safety Net compliance as part of the normal network planning process, ensuring that care is taken to understand our customers’ needs when considering the competing goals of service quality against cost of network.

5.4.3 Risk Quantification and CECV

Energex has also incorporated risk quantification methodology into its planning analysis. This framework provides a way to monetise items such as safety, environmental or bushfire risks.

In June 2022 the AER published their final determination of the Customer Export Curtailment Value (CECV). This methodology provides a mechanism to monetise the value reducing DER generation export due to network limitations and where appropriate help to provide justification for network augmentation.

This acknowledges, that regardless of level of preparation, there will always be combinations of circumstances where it is impossible to meet the restoration targets at the time of an event, for example, if it is unsafe to work on a line due to adverse weather conditions, though these should be rare. In addition, during the planning phase, where the risk of failing to meet the target timelines is identified as being very low probability, investment to further mitigate the risk would generally not be recommended, as per industry best practice.

5.4.4 Distribution Networks Planning Criteria

Distribution feeder ratings are determined by the standard conductor/cable used, and installation conditions/stringing temperature. Consideration is also given to Electro-Magnetic Fields (EMF) impacts, as well as to the reliability impacts of increasing load and customer counts on a distribution feeder.

Target Maximum Utilisation (TMU) is used as a trigger for potential application of non-network solutions or capacity improvements for the 11kV network.

CBD and Critical Loads

In the Energex CBD scenario, and for loads that require full supply redundancy to manage contingencies, meshed networks are utilised. Mesh networks consist of multiple feeders from different bus sections of the same substation interconnected through common distribution substations. A mesh network can lose a single component without losing supply to the customer – with the loss of any single feeder; the remaining feeders must be capable of supplying the total load of the mesh.

In a balanced feeder mesh network, each feeder supplies an approximately equal amount of load and has the same rating, as the name describes. Any feeder in a balanced three feeder mesh should be loaded to no more than 67% utilisation under system normal conditions at 50 PoE. Any feeder in a balanced two feeder mesh should be loaded to no more than 50% utilisation under system normal conditions at 50 PoE.

Mesh networks are more common in the denser Brisbane CBD areas where high reliability is critical and thus the loss of a single feeder should not affect supply.

Urban Feeders

In relation to Safety Net an Urban Feeder is a radial feeder, with ties to adjacent radial feeders. A radial feeder with effective ties to three or more feeders should be loaded to no more than 80% utilisation under system normal conditions at 50 PoE.

Following the loss of a feeder, utilising ties to other feeders allows supply to be restored to the affected feeder without overloading the tie feeders. Values of TMU may need to be adjusted to ensure that there is adequate tie capacity to adjacent zone substations in accordance with the Safety Net criteria.

It is recognised that tie capacity may not be available under all loading conditions because of voltage limitations.

Short Rural Feeders

For a point load that has no ties, or a short rural radial feeder, the TMU will be capped at 0.90 at 50 PoE, unless the supply agreement specifically requires a different value.

Consideration of Distribution Losses

Distribution losses refer to the energy loss incurred in transporting energy across the distribution network. They are represented by the difference between energy purchased and energy sold. Energex includes all classes of market benefits (including network losses) in its analysis that it considers to be material for all projects, including those under the RIT-D and those projects where there is a material difference in losses between options.

5.5 Plant Thermal Ratings

Plant thermal ratings are guided within Energex by the Energy Queensland Limited Plant Rating Manual. The methodology within the manual is written with reference to the appropriate Australian Standards. The plant thermal rating methodology provided encompasses all primary current carrying components of all primary plants including overhead conductors, underground cables, power transformers and substation HV equipment.

An alignment of the plant rating philosophies between Energex and Ergon Energy was completed to form the EQL Plant Rating Manual. The process involved a review of the environmental weather conditions and operational time blocks for overhead static line ratings. As a result of this review, changes have been made to include the entire region of the Energex Network within the (Ergon) Eastern and Coastal climate zone and adopting the ambient temperature and wind speeds throughout the day as shown in Figure 8. The overhead line thermal ratings are affected by conditions such as ambient temperature, wind velocity and solar radiation.

All overhead line assets will maintain their existing ratings calculated using the legacy environmental conditions and assumptions. The new plant rating methodology will be applied to newly installed overhead feeders. Consolidation of new and existing feeder ratings will be undertaken as part of the Digital Enterprise Building Blocks (DEBBs) migration and legacy ratings only used for operational requirements.

Overhead conductors are rated in accordance with Electricity Supply Association of Australia (ESAA) publication D(b)5-1987. Reference is also made to AS 7000-2010 and EQL's environmental assumptions. Energex's current overhead line design is based on a conductor operating temperature of 75°C. The ratings used are intended to maintain statutory clearance and maintain the working life of the conductors whilst obtaining the maximum capacity.

An evening time block has been introduced to the Energex Network is shown in Table 7. A day is now split into day, evening and night/morning for both summer and winter. The shoulder seasonal months of April, May, September, October and November are generally rated with summer parameters.

Table 7 – Energex Distribution Area Climate Parameters

Rating Limits	Summer Day		Summer Evening		Summer Night / Morning		Winter Day		Winter Evening		Winter Night / Morning	
	Dec-Mar		Dec-Mar		Dec-Mar		Jun-Aug		Jun-Aug		Jun-Aug	
	(6am-6pm)		(6pm-10pm)		(10pm-6am)		(6am-6pm)		(6pm-10pm)		(10pm-6am)	
Climate Region	Wind	Ambient	Wind	Ambient	Wind	Ambient	Wind	Ambient	Wind	Ambient	Wind	Ambient
	m/s	°C	m/s	°C	m/s	°C	m/s	°C	m/s	°C	m/s	°C
Eastern & Coastal	1.3	35	0.8	31	0.3	27	1.2	28	0.5	23	0.3	23

Figure 8 – EQL Climate Zones

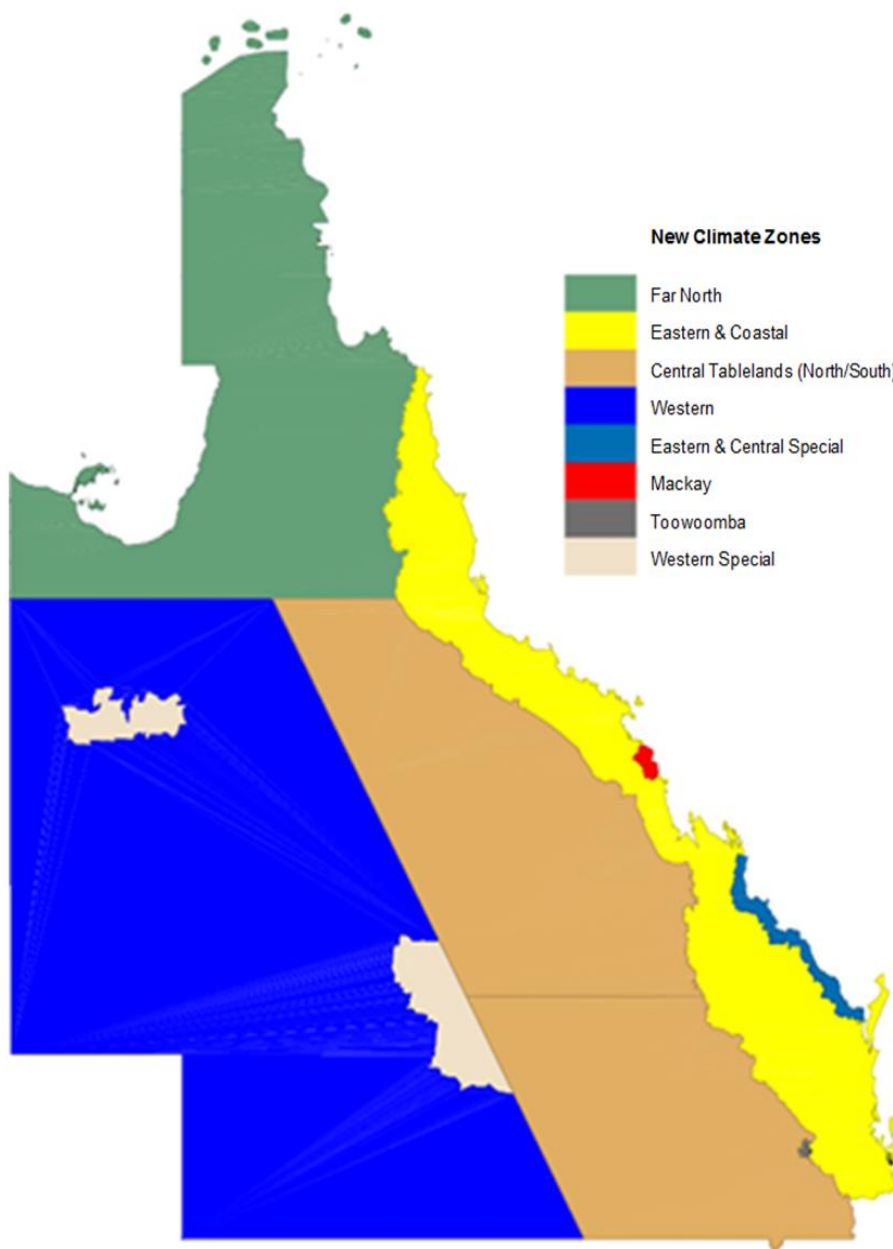

In design of curtailment schemes for renewable and other types of generation, a maximum threshold of 100°C is applied to overhead lines to ensure that generators curtail at a sufficient rate to maintain conductor temperatures below 100°C given the standard set of climate assumptions in Table 7. In general, Energex's plant thermal ratings are determined based on the following:

- Power transformers are rated in accordance with IEC 60076. The vast majority of the Energex power transformer fleet has remote temperature monitoring of their critical internal components. This real time temperature monitoring performs a vital role in the risk management of the transformers when the more arduous ratings are in force. Energex applies up to three different thermal ratings for power transformers dependant on network conditions:

- The Normal Cyclic rating is the maximum permissible peak loading for the applied load cycle that a transformer can supply, given weighted ambient temperatures, without reducing the design life of the transformer
 - The Emergency Cyclic rating is the maximum permissible peak loading for the applied load cycle that a transformer can supply without transgressing any of the physical temperature limitations of the materials of which the transformer is constructed. This rating is only applicable in substations where more than one power transformer shares the load, which is usually the case in Energex substations. This rating allows time for the repair/replacement of faulty plant
 - The Short Time Emergency rating is the maximum permissible loading for the given load cycle that a transformer can supply for up to two hours, immediately following the loss of one of the transformers in a multiple transformer zone substation. By the end of the two-hour period, the load has to be reduced to at least the emergency cyclic rating. This rating allows for load transfers.
- For generators connected to Energex network that result in reverse power flows up to nameplate value, transformer ratings are limited to the base cooling mode of Oil Natural Air Natural (ONAN) for the purpose of the connection. Ageing studies conducted as part of the connection process may apply further restrictions
 - HV switchgears are rated in accordance with AS 62271. HV switchgears also have a number of ratings which are based on the applied load cycle, ambient temperatures and the thermal mass of the individual switchgear. The default rating is the manufacturers nameplate rating of the switchgear
 - Underground cables are rated in accordance with IEC 60853 and IEC 60287 supported by Energex’s environmental assumptions.

5.6 Voltage Limits

5.6.1 Voltage Levels

Energex’s HV distribution network consists of 4 different voltage levels. Table 8 contains the system nominal and the system maximum voltage that equipment is typically manufactured to operationally withstand, and as such the maximum voltage levels that can be imposed without damaging plant.

Table 8 – System Operating Voltages

System Nominal Voltage	System Maximum Voltage
132kV	145kV
110kV	121kV
33kV	36kV
11kV	12kV

5.6.2 Sub-transmission Network Voltage

Target voltages on bulk supply substation busbars are set in conjunction with Powerlink Queensland. In general, the sub-transmission busbars at Powerlink Connection Points are operated without Line Drop Compensation (LDC) and with a fixed voltage reference or automatic Volt Var Regulation (VVR) set point.

Sub-transmission network configuration can impact the voltages on the downstream network. Energex maintains the voltages at the customers’ connection points according to connection agreements where the customers are supplied directly at the 132kV, 110kV or 33kV levels. For all other situations, the sub-transmission network aims to maintain voltage levels at the substation Low Voltage (11kV) buses within a target range. Energex utilises automatic schemes to control the voltages, accounting for the difference in voltage that can occur on the LV side of substations between periods of maximum demand and light load, and during single contingency outage conditions or high solar PV penetration. A voltage limitation occurs if a target bus voltage cannot be maintained. The target range depends on various factors such as the type and magnitude of load, customer category, and connection agreement. This is typically 11.2kV in urban areas and 11.3kV in rural areas during peak load times.

Augmentation of the transmission and sub-transmission network may be required when voltage limitations occur on the sub-transmission network under system normal conditions with 10 PoE forecast loads, or under N-1 conditions with 50 PoE forecast loads consistent with the Safety Net.

Where it can assist in meeting voltage limits, VVR should be applied on zone substation transformers to optimise the voltage regulation on the distribution network. In some instances, issues such as the distribution of load on individual feeders may mean that VVR is not a feasible solution.

These limitations are identified as part of the simulations carried out and described in Section 4.2.3 and are also reported in the limitations tables contained in Appendix C.

5.6.3 11kV Distribution Network

For 11kV distribution systems, the network is operated at supply voltage standard at a customer’s point of connection, as described in Table 10, and considerations are also made to the variable impacts of the different Low Voltage (LV) network configurations on subsequent LV customers supply voltage.

Table 9 provides an indicative level of the maximum HV voltage drops in the distribution network, to ensure acceptable supply voltage to LV customers. The drop defined is from the zone substation bus to the feeder extremity, for steady state conditions or 10-minute aggregate values.

Table 9 – Steady State Maximum Voltage Drop

Energex targets	Maximum voltage drop – no LDC	Maximum voltage drop – LDC
Urban	4%	7%
Short Rural	-	10%

Assessment of the 11kV feeder voltage level is performed using a load flow package with anticipated 10 PoE loads under system normal configuration, or under N-1 conditions with 50 PoE forecast loads.

In the main, the model assumes the following voltage levels at the substation at peak times:

- CBD Substations 99%
- Urban Substations short 101.3%
- Urban Substations Long 101.8%
- Rural Substations 102.7%.

The assessment identifies voltage drops anywhere on the 11kV feeders, and prudent practices are applied to address areas that are outside the allowable limits. Augmentation of the distribution network generally occurs when voltage limitations occur on the distribution network under system normal conditions with 10 PoE forecast loads, or under N-1 conditions with 50 PoE forecast loads.

At present, there are 11kV feeders with voltage constraints identified in the Energex distribution network model during system normal conditions. Operational measures have been identified to address these feeders where a project has not been justified.

5.6.4 Low Voltage Network

There are over 55,000 Low Voltage (LV) feeders in the Energex network. Design guidelines are available to determine transformer tap settings and the After Diversity Maximum Demands (ADMD) for customers.

Energex is required to manage the voltage on these LV circuits within a tolerance range of 230 volts + 10%/-6% (216 volts to 253 volts). There are many factors which impact the voltage present at the customer connection point, including voltage regulation settings at the zone substation, 11kV and LV network planning and design practices as well as customer owned installations such as embedded generators. In particular, the influx of solar PV systems connected to the LV network has added a new level of complexity to voltage management.

Energex has traditionally relied upon maximum demand indicators to identify limitations on distribution transformers. This approach is no longer adequate and Energex is now rolling out distribution transformer monitoring. These monitors, along with customer feedback, are now being used to identify areas of voltage non-compliance. Remedial works are being targeted initially to minimise the risk of damage to customer equipment from voltage excursions with high volts having the highest priority.

Energex has explored a number of remediation works to manage voltage levels of LV networks which include:

- Changes to the LDC or VVR settings at the zone substation
- Resetting distribution transformer taps
- Balancing of the LV network with an emphasis on the solar PV load
- Upgrading of the transformer or installation of a new transformer (to reduce the lengths of LV circuits)
- Increasing the LV conductor size
- Installation of targeted transformer monitoring devices in response to network LV changes and PV installations.

Augmentation of the LV network may be required where rebalancing of customer loads and solar connections or resetting the distribution transformer taps is not sufficient to ensure voltages are within statutory limits. In this case, it is required to reduce the voltage drop through the transformer and LV

circuits typically by uprating or installing a new transformer and reconfiguring the LV network. Low Voltage Regulators (LVR) and Statcoms may also provide an additional reinforcement option.

5.6.4.1 Maximum Customer Voltage

The National Electricity Rules gives utilities the authority to specify the customer supply voltage range within the connection agreement for HV customers above 22kV. The National Electricity Rules requires RMS phase voltages to remain between $\pm 5\%$ of the agreed target voltage (determined in consultation with AEMO), except for at times following a contingency event, where the supply voltage shall remain between $\pm 10\%$ of the system nominal RMS phase to phase voltage. In Queensland, for customers less than 22kV, the Queensland Electricity Regulations (QER) specifies steady-state (i.e. excluding transient events such as transformer energisation) supply voltage ranges for LV and HV customers.

Table 10 details the standard voltages and the maximum allowable variances for each voltage range from the relevant QER and National Electricity Rules.

Table 10 – Maximum Allowable Voltage

Nominal Voltage	Maximum Allowable Variance
<1000V (230V Phase to Neutral 400V Phase to Phase)	Nominal voltage +10%/- 6%
1000V – 22,000V	Nominal voltage +/- 5% or as agreed
>22,000V	Nominal voltage +/- 10% or as agreed

The values in Table 10 assume a 10 minute aggregated value, and allow for 1% of values to be above this threshold, and 1% of values to be below this threshold.

5.7 Fault Level

Fault levels on the Energex network are affected by factors arising within the Energex network or externally, such as the TNSP's network, generators and customer connections.

Fault level increases due to augmentation within the Energex network are managed by planning policies in place to ensure that augmentation work will maintain short circuit fault levels within allowable limits.

Fault level increases due to external factors are monitored by annual fault level reporting, which estimate the prospective short circuit fault levels at each substation. The results are then compared to the maximum allowable short circuit fault level rating of the switchgear, plant and lines to identify if plant is operated within fault level ratings. Energex obtains upstream fault level information from TNSPs annually and changes throughout the year are communicated through joint planning activities as described in Section 5.10.

New connections of Distributed Generation and Embedded Generations which increases fault levels are assessed for each new connection to ensure limits are not infringed. Known embedded generators are added to Energex's simulation models so that the impacts of these generators on the system fault levels

are determined. Table 11 lists design fault level limits that apply at Energex installations.

Table 11 – Energex Design Fault Level Limits

Network Type	Voltage (kV)	Existing Installation	New Installation
		Current (kA)	Current (kA)
Sub-transmission	132	25 / 31.5 / 40	40 (1s)
Sub-transmission	110	25 / 31.5 / 40	25 (3s)
Sub-transmission	33	13.1 / 25	25 (3s)
Distribution	11	13.1	25 (3s)

While Table 11 presents design fault ratings, new equipment typically has ratings higher than these figures, however, some old equipment may have lower ratings. Hence, site specific fault levels are considered in planning activities for network augmentations or non-network solutions to ensure the fault level does not exceed the ratings of the installed equipment. It should be noted that these fault levels are quoted with a 1 second duration, and a faster protection clearing time will be considered where appropriate. This can be further investigated when fault levels approach limits.

5.7.1 Fault Level Analysis Methodology Assumptions

Energex performs fault level analysis at all bulk supply point and zone substation High Voltage (HV) and Low Voltage (LV) buses in our network.

These studies are undertaken using Energex’s sub-transmission network model which has been developed and prepared using the PowerFactory network modelling software program. A transmission network model has been provided by Powerlink and merged with the sub-transmission model at all of Energex’s respective transmission connection points.

Short circuit simulation studies are carried out for 3-phase, 2-phase to ground and 1-phase to ground faults in accordance with IEC 60909 Short-circuit currents in three-phase A.C. systems. Studies are performed to obtain both maximum and minimum fault levels for specific network configurations.

All short circuit simulation results are stored in a database which is then validated and analysed prior to publishing. For meshed networks, additional analysis is carried out to identify the fault current contribution of individual circuits, hence identifying the current which a breaker is subjected to under a fault condition. Equipment having a rated short circuit withstand below the observed fault level are then identified.

5.7.1.1 Maximum Fault Level Analysis

The maximum fault level studies are based on two possible network configurations:

- **System Normal:** where all network elements remain as per their normal state
- **System Maximum:** where all normally open switches are closed within the boundary of a substation to produce the maximum fault level result for that substation.

The network sources used to obtain maximum fault levels for both the system normal and system maximum network configuration are based on Powerlink's maximum generation dispatch scenarios for fault level analysis purposes.

Based on the IEC 60909 standard, the maximum fault level analysis studies are carried out based on the following assumptions:

- A voltage factor of 1.1 is used to create a driving voltage of 1.1 p.u.
- Major network connected generators are assumed to be in operation
- All transformers are fixed at nominal tap
- Conductor temperature of 20°C.

5.7.1.2 Minimum Fault Level Analysis

The minimum fault level studies are based on two possible network configurations:

- **System Normal:** where all network elements remain as per their normal state
- **System N-1:** where a single item of plant is removed from service to produce the minimum fault level result for that substation.

The network sources used to obtain minimum fault levels for both the system normal and system N-1 network configuration are based on Powerlink's minimum generation dispatch scenarios for fault level analysis and system strength assessment purposes.

Based on the IEC 60909 standard, the minimum fault level analysis studies are carried out based on the following assumptions:

- A voltage factor of 1.0 is used to create a driving voltage of 1.0 p.u.
- All network connected generators within the Energex network are assumed to be offline
- All transformers are fixed at nominal tap
- Conductor temperature is referred to the maximum operating temperature

5.8 Planning of Customer Connections

Customer Initiated Capital Works (CICW) are defined as works to service new or upgraded customer connections that are requested by Energex customers. As a condition of our Distribution Authority, Energex must operate, maintain and protect its supply network in a manner that ensures the adequate, economic, reliable and safe connection and supply of electricity to our customers. It is also a condition that it allows, as far as technically and economically practicable, its customers to connect to its distribution network on fair and reasonable terms.

Energex has a [Connection Policy](#)²¹ that details the circumstances in which a customer must contribute towards the cost of its connection and how it is to be treated for regulatory purposes. This Policy came into effect on 1 July 2020.

²¹ Website: https://www.energex.com.au/data/assets/pdf_file/0017/1009052/Connection-Policy-2020-2025.pdf

5.9 Major Customer Connections, including Embedded Generators

Energex is committed to ensuring that, where technically viable, Major Customer Connections (MCC) customers are able to connect to the network. A MCC process is available on our website which aligns with the connection processes in Chapters 5 and 5A of the NER. We have a dedicated Major Customer Team to support MCC. Information on the processes can be found at our [website](#)²².

The process generally applies to proposed connections where the intended Authorised Demand (AD) or load on our network exceeds 1,000kVA (1MVA) or where power usage is typically above 4GWh per annum at a single site.

Energex also has clear processes for the connection of Embedded Generating systems, which applies to Embedded Generations of 30kVA and above. The processes may vary depending on the size of the generating unit and whether the system is exporting into our network. These processes are also listed on our [website](#)²³.

The connection of any MCC or Embedded Generating systems requires various levels of technical review. An assessment into the effect that the connection will have on existing planning and capacity limitations (including component capacity/ratings, voltage regulation limitations and protection limit encroachment, system stability and reliability, fault level impacts and the security criteria) is necessary to ensure that Energex continues to operate the network in a manner that ensures the adequate, economic, reliable and safe connection and supply of electricity to its customers.

5.10 Joint Planning

5.10.1 Joint Planning Methodology

Energex conducts joint planning with distribution network service providers and transmission network service providers as required. Joint planning involves Ergon Energy in the vicinity of Toowoomba and Gympie, Essential Energy, Powerlink, TransGrid and Terranora Link in the vicinity of the NSW & Queensland border.

The joint planning process ensures that different network owners operating contiguous networks, work cooperatively to facilitate the identification, review and efficient resolution of options to address emerging network limitations from a whole of distribution and transmission network perspective. In the context of joint planning, geographical boundaries between transmission and distribution networks are not relevant. Joint Planning follows the same principles and considerations outlined in Sections 5.2 in developing proposed solutions and engaging with stakeholders.

For joint planning purposes, the primary focus is to ensure that network capacities are not exceeded. These limits relate to:

²² Website: <https://www.energex.com.au/our-services/connections/major-business-connections/large-generation-and-batteries>

²³ Website: <https://www.energex.com.au/our-services/connections/major-business-connections/large-generation-and-batteries>

- Thermal plant and line ratings under normal and contingency conditions
- Plant fault ratings during network faults
- Network voltage to remain within acceptable operating thresholds
- Replacement of ageing or unreliable assets
- Network stability to ensure consistency with relevant standards.

5.10.2 Joint Planning and Joint Implementation Register

A register has been set up to capture all information relating to limitation identification, planning, consultation and subsequent project implementation between Energex and external parties. This ensures joint activities are tracked throughout the lifetime of a project, from the time a limitation is identified to final commissioning of the chosen solution. The register is shared with the respective TNSP or DNSP and is updated regularly.

5.10.3 Joint Planning with Powerlink

In the past 12 months Energex has actively engaged with Powerlink on the following joint planning studies. These limitations have network drivers that have a notional target date in the forward planning period (2022-23 to 2026-27), as summarised in Table 12.

Additional joint planning activities have occurred in the past 12 months for network drivers on the Energex, Ergon Energy and Powerlink networks that notionally occur beyond the forward planning period.

Table 12 – Joint Planning Activities Covering 2022-23 to 2026-27

Energex Works Estimated Cost (\$ M)	Project Description	Indicative Timing	2021 DAPR Reported Timing	Comments
1 - 2	Redbank Plains 110kV Replace primary plant (Powerlink Project)	Jun-24	Dec-24	Subject to RIT-T
0	Mudgeeraba 275/110kV transformer replacement/retirement (Powerlink Project)	NA	NA	No Energex works required
0	SEQ reactive power and voltage control (Powerlink Project)	NA	NA	No Energex works required
0.3	Goodna Substation Limitations	Jun-23	NA	Energex to install POP scheme

5.10.4 Joint Planning with other DNSP

There were no specific joint planning network investigations necessary between Energex and other DNSPs during 2021-22. Energex continues to work closely with Ergon through joint business practices. Energex continues to monitor emerging network limitations beyond the forward planning period on the

southern Gold Coast and broader region, associated with Essential Energy, TransGrid, Powerlink and Terranora Link.

5.10.5 Further Information on Joint Planning

Further information on Energex's joint planning and joint network investment can be obtained by submitting email to the following address:

DAPR_Enquiries@energex.com.au

5.11 Network Planning – Assessing System Limitations

5.11.1 Overview of Methodology to Assess Limitations

The methodology shown in Figure 9 is used in the preparation of the Distribution Annual Planning Report to identify and address network limitations, joint planning projects and RIT-D projects.

Figure 9 – System Limitations Assessing Process

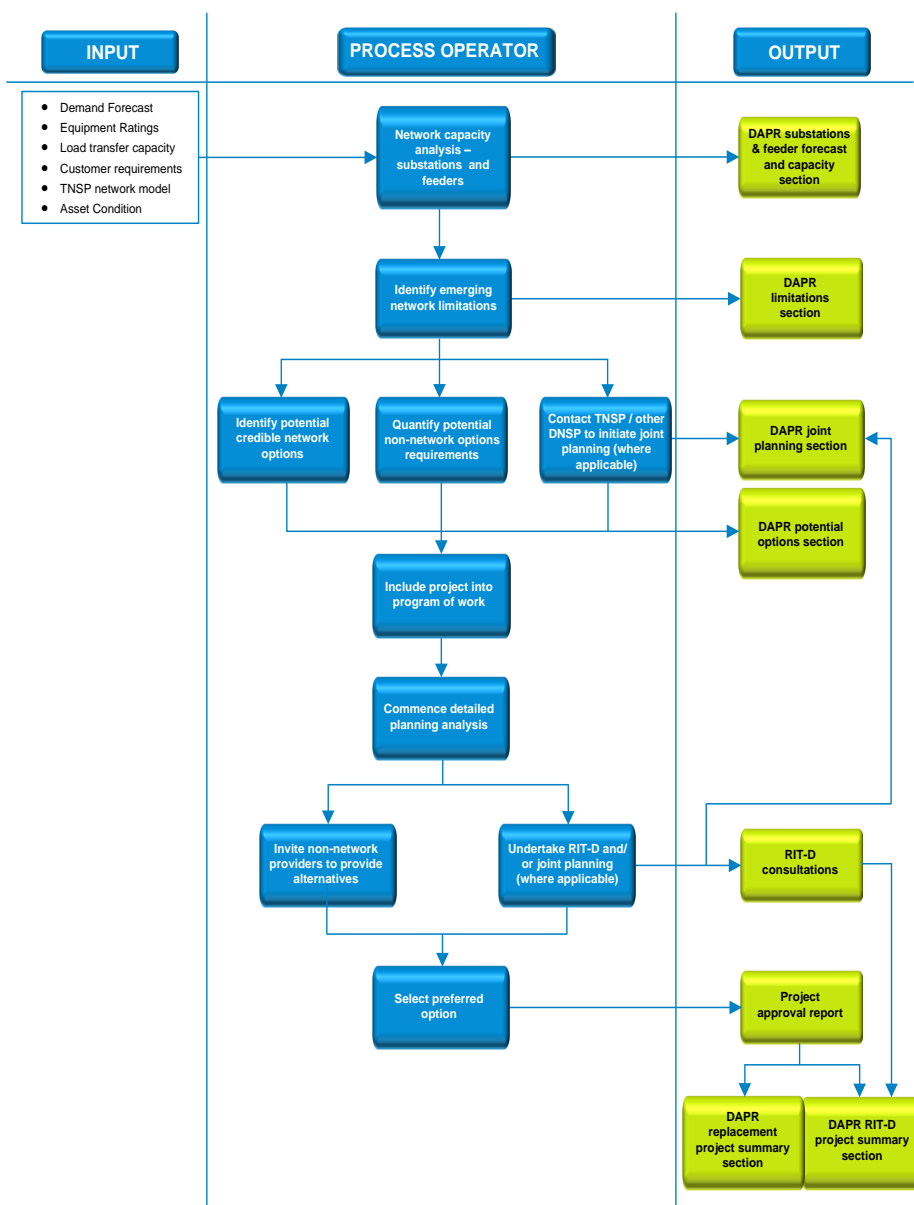

Following the assessment of emerging network limitations, network and non-network options are considered for addressing the prevailing network limitations. These recommendations then become candidate projects for inclusion in the Energex Program of Work (PoW) and are allocated with a risk score based on the Energex network risk-based assessment framework for prioritisation purposes.

The PoW also undergoes ongoing assessment to determine if targeted area demand management activities can defer or remove the need for particular projects or groups of projects. Remaining projects form the organisation’s PoW for the next five years. Detailed planning is also done for each PoW project to complete a RIT-D consultation if required, and obtain project approvals for acquisitions, construction and implementation.

5.11.2 Bulk and Zone Substation Analysis Methodology Assumptions

Energex uses a software tool to assess emerging capacity limitations for all bulk supply and zone substations, taking into account information such as non-network, manual, remote and automated load transfers, circuit breaker/secondary system ratings, generator support and reference to the current

security standards. All reviews are performed annually with comprehensive results included in Appendix D of the DAPR. All assessments are evaluated based on the current network security standards which are detailed in 5.4.2. All calculations are based on the latest load forecasts which align with the forecast information provided in Section 4.3.1.

5.11.3 Sub-transmission Feeder Analysis Methodology Assumptions

Based on the forecasting methodology described in Section 4.2.2 using the simulation tool, load flow studies are performed to identify system limitations on the transmission network under system normal or contingency conditions.

Contingency analysis is performed to identify all overloaded feeders for all credible contingency events. Contingency transfers are not included in this automated model, but are considered in subsequent analysis. The load flow results are then exported to Energex's analysis tools and reporting systems.

Energex reviews and analyses these load flow results using additional data not contained in the model itself. This includes information such as non-network alternatives, load transfer capacities (Manual, Remote and Automatic), circuit breaker/secondary system ratings, generator support and reference to the current security standards. The outcome of the analysis would trigger further investigations and identification of potential solutions to address the limitations.

5.11.4 Distribution Feeder Analysis Methodology Assumptions

The methodology and assumptions used for calculating the distribution feeder constraints are as follows:

- The previous maximum demands are determined from the historical metering/SCADA data for each feeder. These maximum demands are filtered to remove any temporary switching events. Energex temperature corrects these load maximum demands to 50 PoE and 10 PoE load assessments
- The future forecast demands for each feeder are then calculated based on the historical and current customer growth rate, block loads (major developments) and other localised factors
- The worst utilisation period (summer day, summer night, winter day or winter night) are calculated by dividing the period maximum demand by the period rating. This is the determining period which will trigger a potential exceedance
- The year and season (i.e. summer or winter) is recorded where the maximum utilisation exceeds the Target Maximum Utilisation (TMU) for that feeder. The TMU of each feeder takes into account the ability, of generally, transferring loads from four feeders into three feeders with some use of mobile generation to restore all loads in the event of a fault on the 11kV network. This is to allow for operational flexibility and load transfers to restore load during a contingency event. The TMU is generally 80% of the feeder rating for radial feeders, and is individually determined for meshed feeders, dedicated single customer feeders and feeders with limited tie capacity.

Note: the above mentioned methodology is only a planning level criteria, which triggers further detailed analysis based on a number of factors. Not all breaches of these criteria will trigger augmentation.

Chapter 6

Overview of Network Limitations and Recommended Solutions

- Network Limitations – Adequacy, Security and Asset Condition
- 11kV Primary Overcurrent and Backup Protection Reach Limits
- Summary of Emerging Network Limitations
- Regulatory Investment Test (RIT-D) Projects
- Emerging Network Limitations Maps

6 Overview of Network Limitations and Recommended Solutions

6.1 Network Limitations – Adequacy, Security and Asset Condition

There are no limitations identified on the transmission-distribution connection points with the TNSPs covering the forward planning period. Energex conducts joint planning with TNSPs as described in Section 5.10.1. Limitations affecting either network will be investigated jointly and follow the RIT-T or RIT-D process to ensure prudent solutions are adopted.

6.1.1 Bulk and Zone Substation Capacity Limitations

For each bulk and zone substation, a separate summary forecast of load, capacity and limitations has been produced for summer and winter based on the Safety Net. These results are contained in Appendix D. outlines the network limitations that have been identified through this process.

6.1.2 Sub-transmission and Distribution Feeder Capacity Limitations

For each sub-transmission feeder and distribution feeder, a separate summary forecast of load, capacity and available load transfers for summer and winter has also been produced, and the results are also contained in Appendix E. Feeder limitations are identified using the simulation models and processes as described in Section 4.2.2 and Section 5.11.3. The outcome of this analysis would then potentially trigger the creation of new strategic projects which indirectly may or may not trigger an update of the forecast and re-run of the models.

6.1.3 Asset Condition Limitations

Energex has a range of project based planned asset retirements which will result in a system limitation. These retirements are based on the Asset Management Plans outlined in Section 2.4. These projects can be found in Appendix C, Substations Limitations and Proposed Solutions, and Sub-transmission Limitations and Proposed Solutions.

6.1.4 Fault Level Limitations

Energex performs fault level analysis for switchgear at all 132kV, 110kV, 33kV and 11kV buses as well as 33kV and 11kV feeders. Both 3-phase and 1-phase to ground faults are simulated in the studies and the worst case is identified in accordance with IEC 60909 Short-circuit currents in three-phase A.C. systems.

Where fault levels are forecast to exceed the allowable fault level limits, then fault level mitigation projects are initiated. This year's detailed analysis did not identify any additional switchgear fault rating limitations in comparison to the 2021 DAPR.

Table 13 below summarises the identified limitations across the Energex network for the DAPR period.

Table 13 – Summary of Substation and Feeder Limitations

Asset Type		Limitation Type		
		Capacity	Asset Condition	Fault Level
Limitations with Proposed Solutions	Bulk Substation	0	1	0
	Zone Substation	5	16	0
	132kV and 110kV Sub-transmission Feeder	0	0	0
	33kV Sub-transmission Feeder	4	6	0
	Distribution Feeder	10	0	0
Limitations not Addressed	Bulk Substation	3	0	0
	Zone Substation	8	0	0
	132kV and 110kV Sub-transmission Feeder	1	0	0
	33kV Sub-transmission Feeder	7	0	0
	Distribution Feeder	13	0	0

6.2 11kV Primary Overcurrent and Backup Protection Reach Limits

Energex engaged with a consultant to undertake a review of the existing protection settings of 11kV distribution feeders in determining whether a systematic protection issue exists within the network.

As part of the report's recommendation, Energex conducted a review of its 11kV feeder primary protection reach to further improve network safety and increase network transfer tie capabilities.

Six percent of the total Energex 11kV feeders have been identified for potential improvements and is currently being addressed through protection setting changes, installation of 11kV Pole Mounted Reclosers (PMR) and fuses, and 11kV feeder reconductoring works. These works have now been completed. Energex has also developed a program for rectifying backup protection reach limitations at around 100 zone substations across its network. Approximately a quarter of these projects have moved

into construction, and a quarter are approved and have moved into detailed design. The remaining projects are programmed for approval over the next 2-3 years.

6.3 Summary of Emerging Network Limitations

Appendix C provides a summary of proposed committed work in the forward planning period and highlights the upcoming limitations for each bulk supply, zone substation, transmission feeder, sub-transmission and distribution feeders. Potential credible solutions are provided for limitations with no committed works.

6.4 Regulatory Investment Test for Distribution (RIT-D) Projects

6.4.1 Regulatory Investment Test Projects – In Progress

As per the National Electricity Rules clause 5.17.3, and detailed further in Section 2.2 of the RIT-D Application Guidelines (December 2018), a RIT-D proponent is not required to apply the RIT-D for projects where the estimated capital cost of the most expensive potential credible option is less than the RIT-D cost threshold (as varied in accordance with a ‘RIT-D cost threshold’ determination). The RIT-D cost threshold is \$6 million.

The following approved projects shown in Table 14 have credible options greater than the RIT-D cost threshold of \$6 million. As such, the Final Project Assessment Reports for these projects are published in the Energex [website](#)²⁴ under Current Consultations.

Table 14 – In Progress RIT-D Projects

Project Name	RIT-D Forecast/Actual Completion ¹
Jimboomba and Beaudesert Network Limitation	Qtr 2 2023
Lindum	Qtr 1 2023
Rosewood Limitation	Qtr 2 2023
Toogooloowah	Qtr 2 2023
West End Limitation	Qtr 2 2022

¹ Dates correct as of November 2022.

²⁴ Website: <https://www.energex.com.au/our-services/projects-and-maintenance/rit-d-projects>

6.4.2 Foreseeable RIT-D Projects

The forward Energex Program of Work (PoW) includes projects (having credible network options costing more than \$6 million) that have the potential to become RIT-D projects. A summary list of such projects that have been identified to address emerging network limitations in the forward planning period is shown in Table 15.

Table 15 – Potential RIT-D Projects

Project Name	RIT-D Commencement ¹
West End 3rd Transformer	Q1 2025

¹ Dates correct as of November 2022.

6.4.3 Urgent or Unforeseen Projects

During the year, there have been no urgent or unforeseen investments by Energex that would trigger the RIT-D exclusion conditions for the application of regulatory investment testing.

6.5 Emerging Network Limitations Maps

This section covers the requirements outlined in the NER under Schedule 5.8 (n), which includes providing maps of the distribution network, and maps of forecasted emerging network limitations. The extent of information shown on maps, using graphical formats, has been prepared to balance adequate viewing resolution against the number or incidences of maps that must be reported. In addition to system-wide maps, limiting network maps are broken up into groupings by voltage. For confidentiality purposes, where third party connections are directly involved, the connecting network is not shown.

This information is provided to assist parties to identify elements of the network using geographical representation. Importantly, this does not show how the network is operated electrically. More importantly, this information should not be used beyond its intended purpose.

Following feedback from customers, interactive maps are now available on the Energex website via the following link: [DAPR Map 2022](#)²⁵

The maps provide an overview of the Energex distribution network, including:

- Existing 132kV, 110kV and 33kV feeders
- Existing bulk supply and zone substations
- Future bulk supply and zone substations approved in the five year forward planning period
- Existing 132kV, 110kV and 33kV feeders with identified Safety Net limitations within the five year forward planning period
- Existing bulk supply and zone substations with identified Safety Net limitations within the five year forward planning period.

²⁵ Website: <https://www.energex.com.au/daprmap2022>

Chapter 7

Demand Management Activities

- What is Demand Management
- How Demand Management integrates into the Planning Process
- Energex's Demand Side Engagement Strategy
- What has the Energex DM Program Delivered over the last year
- Energex DM Program delivery over the next year
- Key Issues Arising from Embedded Generation Applications

7 Demand Management Activities

Demand Management (DM) is part of our suite of solutions for network management which may be used instead of, or in conjunction with, investments in network infrastructure to ensure an optimised investment outcome.

7.1 What is Demand Management

In the context of electricity networks, DM is the act of modifying demand and/or electricity consumption, for the purpose of reducing or delaying network expenditure (i.e. removing or delaying an underlying network constraint). This definition recognises that DM need not be specific to removing networks constraints only at times of peak demand. It can also provide solutions in response to the retirement or replacement of an aging asset; redundancy support during equipment failure; minimum demand and associated issues with voltage, system frequency and power quality management; managing diverse power flows and system security issues. With rapidly growing DER in the network, DM must evolve to include management of these customer assets to optimise end-to-end investment.

DM can also be particularly valuable when there is uncertainty in demand growth forecasts, as DM does not lock in long-term irreversible investment. In these situations, DM can provide considerable 'option value' and flexibility.

DM solutions are also known as non-network solutions as they provide an alternative to network based solutions. In the Energex and Ergon Energy context, DM involves working with our customers and DM providers to modify demand and/or energy consumption to reduce operational costs or be an alternative to capital expenditure. The more capital expenditure that can be deferred or avoided, the greater the savings to our customers.

DM must be deployed to match the temporal (i.e. how often and what duration) and spatial (i.e. what level of the network and how many customers are affected) nature of the network constraint. As more DER is connected to our network, the temporal and spatial nature of network constraints will change. As such, our DM capability will need to adapt to suit these new and emerging network constraints.

There are different approaches to DM as listed below and shown in Figure 10.

- Demand Response (DR) which is used when required
- Energy efficiency, which results in permanent reduction of demand
- Strategic load growth, which results in permanent increase of demand, beyond 'valley filling'.

These approaches are implemented by customers or DM providers in exchange for financial incentives or as required by a connection standard.

Figure 10 – DM Approaches

Description	
<p>Demand Response (DR): Temporary modification of load or generation as required (e.g. in response to signal from network or price signal). There are different types of DR used for wholesale, emergency, network and ancillary services.</p>	
<p>Peak shaving – reducing demand during peak period (e.g. using onsite generation or battery storage). PeakSmart air conditioning is an example of emergency DR aimed at ‘peak shaving’.</p>	
<p>Load shifting – shifting demand outside of peak demand periods. Load control tariffs are an example of network DR aimed at ‘load shifting’. They can also be used for emergency DR.</p> <p>Valley filling – shifting demand into periods of low demand. Time of Use (TOU) tariffs and load control tariffs are examples of network and wholesale DR aimed at ‘valley filling’.</p>	
<p>Flexible load and generation – modifying load and generation according to DR signals, published technical constraint envelopes and energy market prices (e.g. batteries could be charged during times of low demand). The Dynamic Customer Connection consultation²⁶, Dynamic Operating Envelopes (DOE), Vehicle to Grid (V2G) trials and AEMO’s recent Wholesale Demand Response Mechanism consultation²⁷ are potential future examples of wholesale and/or network DR platforms, strategies and approach.</p>	
<p>Energy Efficiency: Permanent reduction of demand, at peak times and non-peak times.</p>	
<p>Energy efficiency – using less electricity to perform the same task.</p>	
<p>Strategic flexible load growth: permanent increase of demand (where network capacity allows), beyond ‘valley filling’.</p>	
<p>Strategic flexible load growth – encouraging new loads (where network capacity allows), beyond valley filling. For example, growth in EVs and other modes of electric transport and electrification of industrial processes.</p>	

- — Typical residential customer load profile
- — Load or generation after demand management
- — Typical solar generation

²⁶ Website: <https://www.talkingenergy.com.au/dynamicder>

²⁷ Website: <https://aemo.com.au/en/initiatives/trials-and-initiatives/wholesale-demand-response-mechanism>

For more detailed information concerning our DM plans including strategy, customers and challenges please refer to our [Demand Management Plan \(April 2022\)](#)²⁸.

7.2 How Demand Management integrates into the Planning Process

The planning process as outlined in Chapter 5 includes the identification of network constraints and the assessment of DM solutions. When a network constraint is identified, a screen of non-network options is completed to determine if DM solutions offer credible options. Where a screening test finds that a non-network option may provide an efficient alternative solution (by partially or fully addressing the constraint), market engagement and investigation of possible DM solutions is initiated.

'In market' engagement activity depends upon forecast expenditure, size and timing of the constraint. Where total capital expenditure of the most expensive credible option is greater than \$6 million, a RIT-D is undertaken. For the list of projects that required a RIT-D assessment over the last year refer to Section 6.4 and RIT-D consultation information available on the Energex [website](#)²⁹.

Where the forecast capital expenditure for the most credible option is less than \$6 million, opportunities for credible non-network solutions are developed by gauging interest and ability of service providers and customers to participate. This is achieved by inviting proponents to respond to a Request for Proposal (RFP).

Where a non-network solution is selected, a contract is established with the customer to provide permanent (energy efficiency) or point in time (when required) demand response. Measurement and verification is undertaken to determine the response achieved. The verified change in demand becomes an input into the forecast and the planning process. Figure 11 and Figure 12 show the process of non-network solution assessment process for project expenditures smaller and greater than \$6M respectively.

²⁸ Website: https://www.energex.com.au/_data/assets/pdf_file/0010/1006669/Demand-Management-Plan-2022-23.pdf

²⁹ Website: <https://www.energex.com.au/our-services/projects-and-maintenance/rit-d-projects>

Figure 11 – Non Network Assessment Process for Expenditure <\$6M

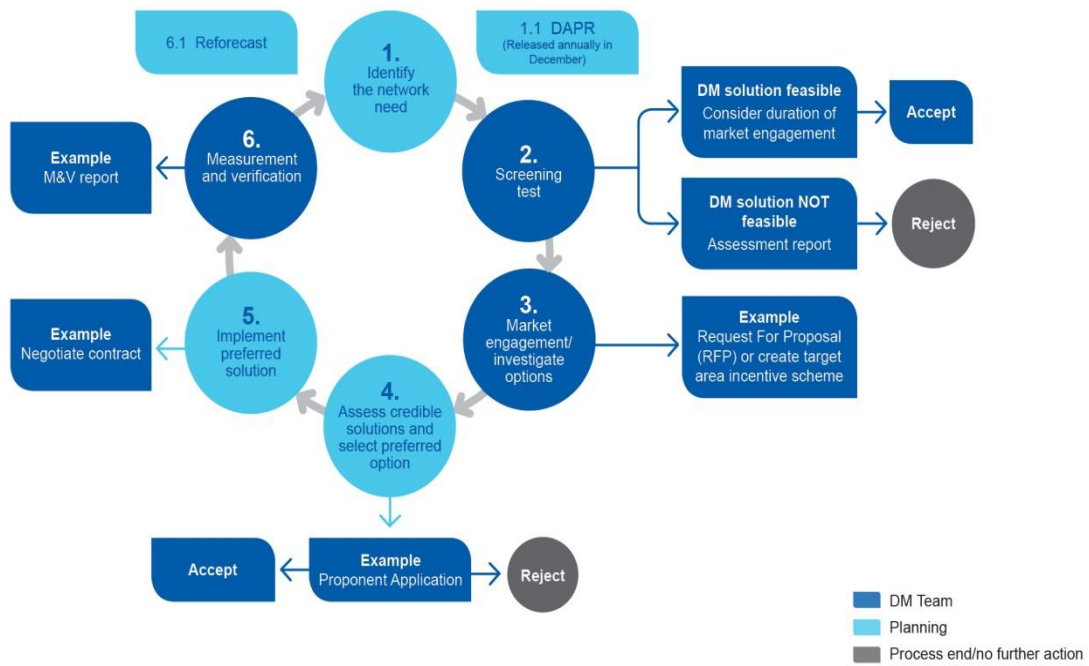
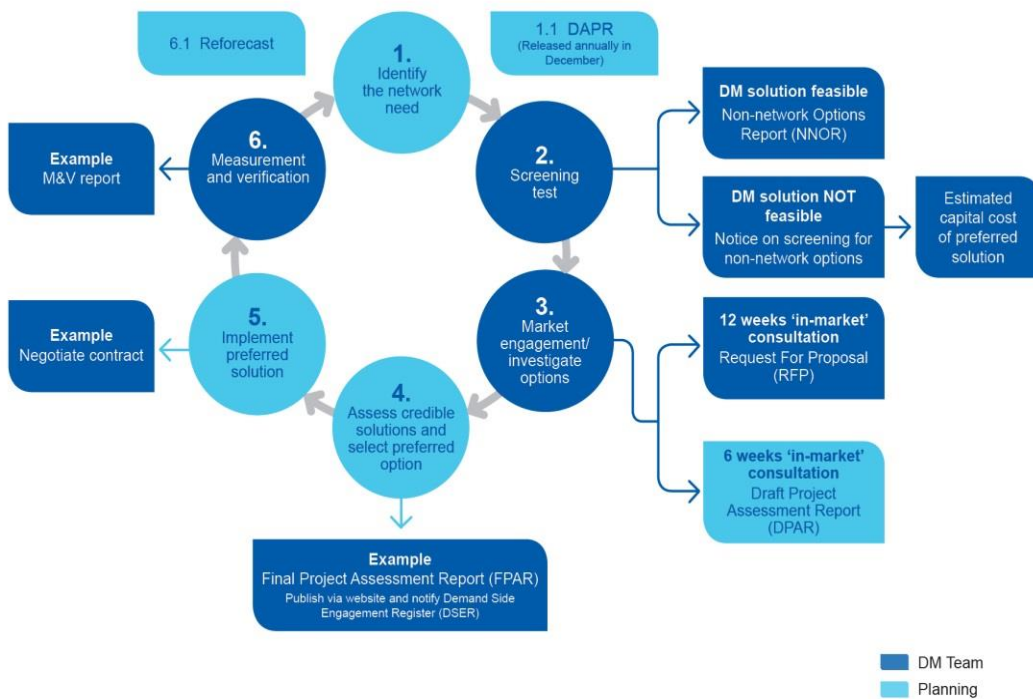

Figure 12 – Non Network Assessment Process for Expenditure >\$6M (RIT-D)



7.3 Energex's Demand Side Engagement Strategy

The Energex Demand Side Engagement Strategy (DSES) communicates how Energex engages with customers and non-network solution providers with respect to the supply of credible demand side solutions to address system constraints and lower costs for customers in the network distribution areas. The DSES retains our commitment to:

- Embed demand side engagement and non-network screening of network constraints into the distribution planning process
- Identify and transparently provide details of Energex network constraints to customers and non-network service providers in consistent, simple and easy to understand terminology
- Identify and incentivise non-network solutions for broad based and targeted areas, engaging stakeholders and third party providers, as outlined in the Energex Demand Management Plan
- Provide adequate time, support and mechanisms for stakeholders to engage, respond and participate in non-network solutions
- Deliver and report non-network solutions that prevent, reduce or delay the need for network investment.

A copy of the DSES can be found on our [website](#)³⁰.

7.4 What has the Energex DM Program delivered over the last year?

Four key initiatives were delivered by the DM Program in 2021-22:

- Broad based
- Targeted
- DM Development
- DM innovation.

7.4.1 Broad based Demand Management

This initiative is available to residential and small business customers across the whole network. Demand reductions can occur across the whole network, rather than just in a local area with a network constraint. Broad based DM delivers direct control of loads during periods of extreme demand or emergency response. This capability is called up through our Summer Preparedness Plan (refer to Section 9.3.1) to minimise interruptions during summer season extreme weather conditions.

Incentives are provided to customers who enrol their PeakSmart air conditioners or connect their appliances to load control tariffs. Incentives are also given to industry partners who install PeakSmart enabled air conditioners. For more information on PeakSmart visit our [website](#)³¹.

³⁰ Website: https://www.energex.com.au/_data/assets/pdf_file/0020/1005725/Demand-Side-Engagement-Strategy.pdf

³¹ Website: <https://www.energex.com.au/manage-your-energy/cashback-rewards-program/peaksmart-air-conditioning/peaksmart-air-conditioning-rewards>

7.4.2 Targeted Demand Management

This initiative is available to customers and DM providers who can deliver DM solutions in specific areas of the network identified as having future network constraints (refer Sections 6.1 Sub-transmission Feeder Limitations, 11kV Distribution Feeder Limitations and Appendix E). Market engagement is undertaken to seek DM solutions from customers and DM providers. Incentives are offered to customers or DM providers to deliver DM solutions.

In 2021-22, 'in market' engagement for DM solutions continued via numerous Regulatory Investment Test consultations and Distribution Feeder Target Areas across the region (refer 6.4). Verified customer and service provider DM solutions in these areas, which met technical, time and cost requirements were incentivised to deliver demand reductions. In addition, Energex is currently managing one network support agreement to provide non-network solutions during the 2021-2022 year. Early market engagements were released seeking Request for Proposals (RFP) for 14 distribution feeder limitations in SEQ.

7.4.3 Demand Management Development

This initiative drives continuous improvement of existing initiatives and enabling future DM capability. This included promoting DM through:

- Contributing and engaging in a range of market and industry consultations and forums with DM providers, manufacturers, large retailers and aggregators
- Influencing DM related standards and regulations including the suite of AS/NZS 4755 standards, which outline demand response capabilities for residential appliances. The new standard AS 4755.2 currently being finalised, is expected to increase adoption of standardised demand response by appliance manufacturers, aggregators and networks. This will enable further innovation and software solutions for demand response of appliances
- Supporting network tariff reform by leading the development of proposed tariff trials in partnership with two electricity retailers to commence in the first quarter of 2023
- Coordinating the development of an emergency backstop mechanism (refer to Section 11.7) , to implement the required system, documentation and process changes to enable the Connection Standards to reflect the backstop requirements
- Working with industry partners to develop products which enable the demand response market, e.g. home energy management systems. Trials of these offers have been underway
- Working with electric vehicle stakeholders to get a greater understanding of potential impacts associated with EVs charging on the network and educating and informing the market
- Direct Load Control trial to inform the design for Audio Frequency Load Control configurations to maximise solar soak and minimise impact on customers' amenity and ensure capability is still available to manage peak loads.

7.4.4 Demand Management Innovation

The initiative supports future energy choices and DM capabilities that reduce long term network costs. A suite of innovative trials and projects to test and validate DM products and processes are funded via Demand Management Innovation Allowance Mechanism (DMIAM). These trials and projects are often started in response to emerging network challenges and opportunities (refer to Section 6.1).

A DMIAM annual report is developed each year that summarises current and completed projects. The latest report can be found on our website: [DMIAM Annual Report](#)³².

7.5 Energex DM Program delivery over the next year

Annually, Energex publishes a Demand Management Plan which includes our strategy for the next five years. Our strategy is to:

- Ensure efficient investment decision making
- Incentivise customer efficiency
- Active customer response enablers
- Manage two-way energy flows
- Transform supply at the Fringe of Grid
- Invest in innovation.

This plan explains our approach for delivering the Demand Management Program for Queensland and represents the initiatives and activities for the next financial year including the promotion of non-network solutions. A copy of our [Demand Management Plan 2022-23](#)³³ is available [online](#)³⁴. While striving to meet our long term strategy, our DM portfolio will continue to evolve in response to system and local network needs and as innovations are implemented. Some of the key focus areas of action for 2022-23 will be to undertake a vehicle to grid functionality trial; a capacity tariff trial in partnership with a Retailer(s); increase network DER hosting capacity through improved network visibility and dynamic operating envelopes; and trialling batteries with customers in remote areas.

Further information on our DM program and the promotion of non-network options are detailed on our [Cashback Reward](#)³⁵ website pages.

In the forward planning period, those areas for which we will be seeking non-network solutions will be published via our Current Consultation [pages](#)³⁶ on our website.

7.6 Key Issues Arising from Embedded Generation Applications

Energex continues to focus on improving efficiency and satisfying customer experiences. The continued focus on the revision of processes, together with additional training for technical staff continues the path to developing a more customer-centric approach.

³² Website: <https://www.energex.com.au/manage-your-energy/managing-electricity-demand/demand-management-innovation-allowance>

³³ Website: https://www.energex.com.au/_data/assets/pdf_file/0010/1006669/Demand-Management-Plan-2022-23.pdf

³⁴ Website: https://www.energex.com.au/_data/assets/pdf_file/0005/1006691/Demand-Management-Innovation-Allowance-Report-2019-20.pdf

³⁵ Website: <https://www.energex.com.au/manage-your-energy/cashback-rewards-program/peaksmart-air-conditioning/peaksmart-air-conditioning-rewards>

³⁶ Website: <https://www.energex.com.au/our-services/projects-and-maintenance/rit-d-projects>

Key issues for Embedded Generation include:

- Voltage management on distribution feeders with significant solar PV generation connected
- Fault level impacts including the increase in fault levels exceeding the rating of shared distribution assets located in the vicinity of embedded generator connections involving rotating machine generators
- Management of operational issues with an increasing number of embedded generators.

These issues present on-going challenges for Energex in terms of managing operational costs while also maintaining compliance, safety and quality of supply to the standards required by regulations.

7.6.1 Connection Enquiries Received

Energex has established processes which apply to connection enquiries and applications for embedded generators. These processes comply with the requirements of the National Electricity Rules. In 2021-22 the number of connection enquiries received is shown in Table 16. For micro EG 30kW or less (mainly solar PV), there is no connection enquiry phase i.e. all connection requests are processed as applications.

Table 16 – Embedded Generator Enquiries

Connection Enquiries	Number 2021-22
Embedded Generator (EG) Connection Enquiries – Micro EG 30kW or less	Not applicable
Embedded Generator Connection Enquiries >30kW Low Voltage	594
Embedded Generator Connection Enquiries >30kW High Voltage	0

7.6.2 Applications to Connect Received

In 2021-22 the number of applications to connect is shown in Table 17.

Table 17 – Embedded Generator Applications

Connection Applications	Number 2021-22
Embedded Generator Connection Applications – Micro EG 30kW or less	39,485
Embedded Generator Connection Applications >30kW Low Voltage	267
Embedded Generator Connection Applications >30kW High Voltage	0

7.6.3 Average Time to Complete Connection

In 2021-22 the number of applications received and connected took an average time to complete as shown in Table 18.

Table 18 – Embedded Generator Applications – Average Time to Complete

Connection Applications	Average time to complete 2020-21
Embedded Generator Connection Applications – Micro EG 30kW or less	18 business days
Embedded Generator Connection Applications >30kW Low Voltage	170 business days
Embedded Generator Connection Applications >30kW High Voltage	N/A

Note: Typically, there are no applications for connection of large renewable generation to Energex' sub-transmission networks

Chapter 8

Asset Life-Cycle Management

- Approach
- Preventative Works
- Line Assets and Distribution Equipment
- Substation Primary Plant
- Substation Secondary Systems
- Other Programs
- De-Rating

8 Asset Life-Cycle Management

8.1 Approach

Energex has a legislated duty to ensure all staff, the Queensland community and its customers are electrically safe. This duty extends to eliminating safety risks based on the “so far as is reasonably practicable” principle. If elimination of a safety risk is not practical, our responsibility is to mitigate risks based on the same principle.

Energex’s approach to asset life-cycle management, including asset inspection, maintenance, refurbishment and renewal, integrates several key objectives, including:

- Achieving its legislated safety duty
- Delivering customer services and network performances to meet the required standards
- Maintaining an efficient and sustainable cost structure.

Policies are used to provide corporate direction and guidance, and plans are prepared to provide a safe, reliable distribution network that delivers a quality of supply to customers consistent with legislative compliance requirements and optimum asset life. These policies and plans cover equipment installed in substations, the various components of overhead powerlines, underground cables and other distribution equipment.

The policies and plans define inspection and maintenance requirements, and refurbishment and renewal strategies for each type of network asset. Asset life optimisation takes into consideration maintenance and replacement costs, equipment degradation and failure modes as well as safety, customer, environmental, operational and economic consequences.

All assets have the potential to fail in service. Energex’s approach to managing the risk of asset failures is consistent with regulatory requirements including the *Electricity Act 1994 (Qld)*, *Electrical Safety Regulation 2002* and the *Electricity Safety Code of Practice 2010 – Works and good asset management practice*. We distinguish between expenditure for:

- Inspection and preventative maintenance works, where each asset is periodically assessed for condition, and essential maintenance is performed to ensure each asset continues to perform its intended function and service throughout its expected life
- Proactive refurbishment and replacement, where the objective is to renew assets just before they fail in service by predicting assets’ end-of-life based on condition and risk
- Run-to-failure refurbishment and replacement, which includes replacing assets that have failed in service.

A proactive approach is undertaken typically for high-cost, discrete assets, such as substation plant, where Energex records plant information history and condition data. This information is used to adjust maintenance plans and schedules, initiate life extension works if possible, and predict the remaining economic life of each asset. Proactive replacement or refurbishment is then scheduled as near to the predicted end of economic life as practical. This approach is considered the most prudent and efficient approach to achieve all required safety, quality, reliability and environmental performance outcomes, having regard for the whole-of-life equipment cost. The consequence of failure impacts the priority for replacement of the asset in the overall works program.

Low-cost assets, where it is not economic to collect and analyse trends in condition data, are operated to near-run-to-failure with minimal or no intervention. These assets are managed through an inspection regime, which is also required under legislation. The objective of this regime is to identify and replace assets that are very likely to fail before their next scheduled inspection. In addition, asset class collective failure performance is assessed and analysed regularly, with adverse trends and increasing risk issues becoming drivers for targeted maintenance, refurbishment or replacement programs.

Actual asset failures are addressed by a number of approaches depending on the nature of the equipment, identified failure modes and assessed risk. The approaches include on-condition component replacement, bulk replacement to mitigate similar circumstances, risk-based refurbishment/replacement and run to failure strategies.

All inspection, maintenance, refurbishment and renewal works programs are monitored, individually and collectively, to ensure the intended works are performed in a timely, safe and cost-effective fashion. These outcomes feed back into asset strategies to support prudent and targeted continuous improvement in life cycle performance overall.

8.2 Preventative Works

Energex manages safety and service compliance requirements via various preventative inspection and minor maintenance programs. These are collectively described below.

8.2.1 Asset Inspections and Condition Based Maintenance

Energex generally employs condition and risk-based asset inspection, maintenance, refurbishment and replacement strategies in line with its asset management policies and strategies discussed in Section 2.4. End-of-economic-life replacement and life-extension refurbishment decisions are informed by risk assessments considering safety, history, performance, cost, and other business delivery factors.

All equipment are inspected at scheduled intervals to detect physical indications of degradation exceeding thresholds that are predictive of a near-future failure. Typical examples of inspection and condition monitoring activities include:

- Analysis of power transformer oil to monitor for trace gases produced by internal faults
- Inspection of customer service lines
- Assessing the extent of decay in wood power poles to determine residual strength
- Inspection of timber cross-arms to detect visible signs of degradation
- Inspection of cable pits
- Electrical testing of circuit breakers.

In particular, Energex has a well-established asset inspection program to meet regulatory requirements. All assets are inspected in rolling period inspection programs.

Remedial actions identified during inspections are managed using a risk assessed priority code approach. Pole assets, for example, employ a Priority 1 (P1) coding which requires rectification within thirty (30) days and Priority 2 (P2) unserviceable poles require rectification within six months. This ensures the required actions are completed within the recommended regulatory standards.

Consistent with the principles of ISO 55000 Asset Management, Energex is building its capability with an ongoing investment into technologies that deliver improvement in risk outcomes and efficiency. These efforts include utilising LiDAR data from the aerial asset and vegetation monitoring management technology. This aircraft-based laser and imaging capture system provides spatial mapping of the entire overhead line network. The data captured is processed to enable identification and measurement of the network and surrounding objects such as buildings, terrain and vegetation. The system creates a virtual version of the real world to allow the fast and accurate inspection and assessment of the physical network and the surrounding environment, particularly vegetation. The integration of this information into our decision framework and works planning processes is increasingly delivering productivity and efficiency improvements, not only with vegetation management but with other network analytics such as clearance to ground analysis, clearance to structure analysis, pole movement and leaning poles analysis with other innovative identification systems being developed.

8.2.2 Asset Condition Management

The processes for inspection and routine maintenance of Energex's assets are well established and constantly reviewed. Energex uses its asset management system to record and analyse asset condition data collected as a part of these programs. Formal risk assessments are conducted for all asset classes, identifying failure modes and consequences, as well as suitable mitigation measures. The results of these programs are regularly monitored, with inspection, maintenance, refurbishment and renewal strategies evolving accordingly. These strategies in turn are used to inform forecast expenditure.

Energex employs EA Technology's Condition Based Risk Management (CBRM) modelling methodology for assets where the effort required to develop, maintain and collect the information required to support the models is justified. This methodology combines current asset condition information, engineering knowledge and practical experience to predict future asset condition, performance and residual life of assets. The CBRM system supports targeted and prioritised replacement strategies. This technique is currently used for Substation Power Transformers, Circuit Breakers and Instrument Transformers as well as Underground Cables of 33kV and above.

The outputs from CBRM, Health Indices, are used in conjunction with an engineering assessment to form the basis of the application of the risk-based methodology. The risk-based methodology allows Energex to rank projects based on their consequence of failure in addition to their probability of failure. The development of the asset investment plan and specific projects are based on the risk score in conjunction with the engineering assessment and optimised to derive the asset investment program.

Figure 13 provides a summary of the process for delivering network asset investment planning condition-based risk management.

Figure 13 – Process to Create Asset Investment Plan

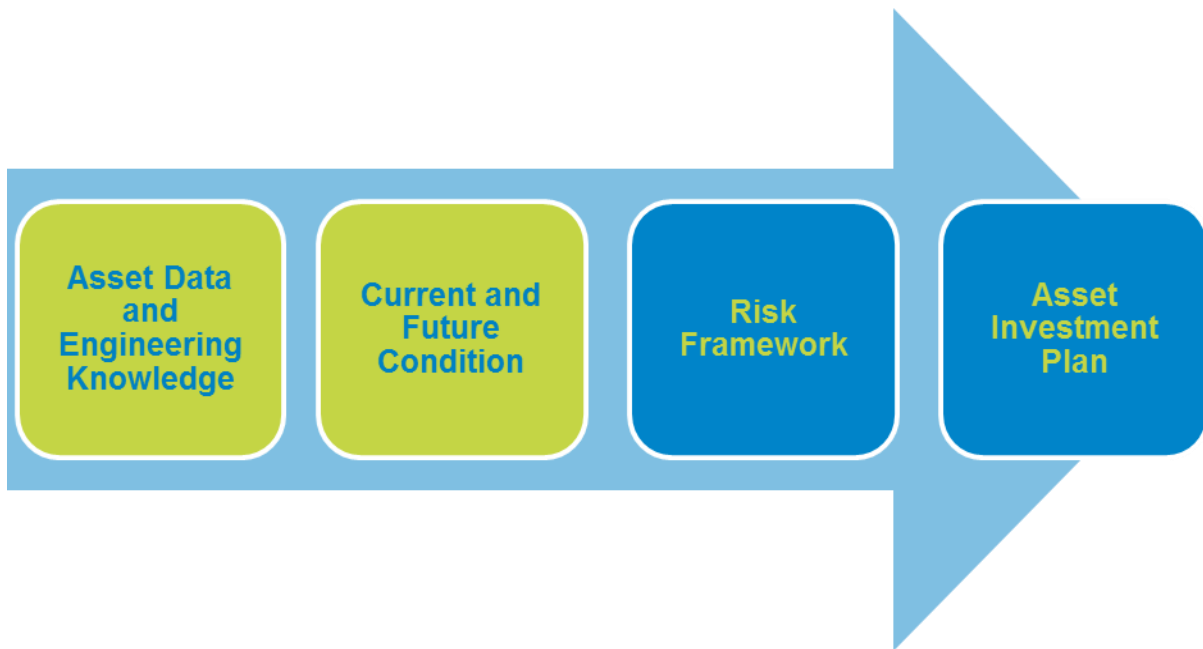

Energex manages the replacement of assets identified for retirement through a combination of specific projects and more general programs.

Projects are undertaken where limitations are identified that are specific to a substation or feeder. Limitations of this nature are considered in conjunction with other network limitations including augmentation and connections to identify opportunities to optimise the scope of the project to address multiple issues and minimise cost. Project planning is undertaken in accordance with the Regulatory Investment Test for Distribution (RIT-D) which considers the ongoing need for the asset to meet network requirements as well alternative solutions to replacement and the impact on system losses where material. Assets without an ongoing need are retired at economic end of life and are not considered for replacement.

Programs of replacement are undertaken when the scope of works to address the identified limitations is recurring across multiple locations and does not require consideration under the Regulatory Investment Test for Distribution.

The following sections provide a summary of the replacement methodologies for the various asset classes in the Energex network.

8.3 Line Assets and Distribution Equipment

8.3.1 Pole and Tower Refurbishment and Replacement

Poles and towers are inspected periodically as required by Queensland legislation. Poles require very little maintenance except for removal of vegetation and termite and bacteria barrier treatments, normally carried out during the inspection process. The majority of pole replacement is driven by well-established inspection programs used to identify severe structural strength degradation. Structural strength is determined in accordance with AS 7000.

A small volume of poles are also replaced when undertaking reconductoring programs as an efficient means of work delivery. Poles replaced under reconductoring programs will be either identified as approaching end of life based on asset criteria or as a result of mechanical design requirements to support the new conductor.

Targeted pole replacement programs make up the small remainder of the forecast. This program is estimated, based on a combination of criteria that identify assets approaching end of life and that present a high risk in the event of in-service failure. The criteria used are a combination of pole type, age, location, previous strength assessment and/or the period the pole has been nailed. Risk is largely determined by the location, with priority being given to replacement in high risk areas such as the vicinity of schools and public amenities.

Pole nailing is a mid-life refurbishment method intended to restore ground line structural strength lost due to below-ground bacterial degradation and is applied based upon inspection outcomes. To date, pole nailing achieves an average of 15 years additional asset life. Historical, nailing volumes have been used to forecast future nailing volumes.

8.3.2 Pole Top Structure Replacement

Pole top structure condition and failure consequence risks (safety, customer reliability, environmental and business) are regularly assessed through asset inspection and defect identification processes. The majority of pole top replacements are driven from the inspection and defect management process and are funded through OPEX for the Energex network. Replacements funded through OPEX are not detailed in this document.

The majority of pole top structure replacements funded through REPEX based programs are replaced as part of conductor and pole replacement programs. High risk aging populations of pole top structures, specifically crossarms, are replaced through targeted replacement programs and contribute to the overall REPEX replacement volume. Crossarms flagged to be replaced as part of targeted replacement programs are combined with other assets to identify sections of the network that present higher risk in order to determine prioritisation of replacements.

8.3.3 Overhead Conductor Replacement

Overhead conductor condition is difficult to assess in-situ as current visual inspection methods can only identify surface defects. Conductor age, type, construction, environment and in-service performance history are used as proxies for condition. Energex employs a data driven refurbishment software tool to identify overhead conductor operating at beyond its expected technical life based on the replacement criteria documented in the Asset Management Plan (AMP) – Overhead Conductors. At-risk conductor is then field assessed by subject matter experts during project scoping to validate the corporate data

and assess the asset in service. The number of splices/joints identified in each span is used as an indicator of in-service condition.

3/12G galvanised steel (SC/GZ) and small diameter Hard Drawn Bare Copper (HDBC) conductors have been identified and confirmed as prone to failure due to corrosion and mechanical fatigue caused by reduced stranding and cross-sectional area. These populations contribute significantly to the in-service failures and defects observed on the Energex network. Refer to the Asset Management Plan for a comprehensive breakdown of the installed population, current levels of service and current and emerging technical issues.

Due to the geographically dispersed nature of the network, populations of conductor are subject to different operating environments and failure modes. Targeted programs are therefore aimed at known problematic conductor types and initially focused on those installed in populated, coastal regions where the likelihood of in-service asset failure is considered greater. Remaining aged populations are managed through routine inspection programs with ongoing monitoring of conductor failure rates and performance metrics.

The prioritised scope of HV and LV distribution overhead conductor reconductoring is:

- All hard drawn bare copper 7/0.104" imperial and smaller aged 70+
- All galvanised steel 3/12 imperial conductor aged 55+
- Small diameter ACSR imperial conductor aged 70+.

Additionally, this approach has identified at risk 33kV conductor operating at or beyond its technical life based on condition, which presents a significant safety risk to electricity workers and the general public.

8.3.4 Underground Cable Replacement

Energex employs Condition Based Risk Management (CBRM) to forecast the retirement of underground cables greater than or equal to 33kV. Asset condition and failure consequence risks (safety, customer reliability, environmental and business) are regularly assessed for each cable within this population. This begins with a "Health Index" (HI) developed to represent asset condition. A higher HI value represents a more degraded asset, with corresponding higher likelihood of failure. In turn, this reflects as a higher likelihood of inability to achieve the basic customer energy delivery service. Energex considers assets for replacement when HI reaches 7.5. The Energex risk framework is applied to prioritise asset replacement at a program level within financial and resource constraints.

In general, distribution and Low Voltage (LV) cables are replaced upon identified defect or ultimate failure.

Underground cable assets are inspected periodically, as required by Queensland legislation. At transmission and sub-transmission voltages, routine maintenance monitors the electrical condition of the cable over sheaths and sheath voltage limiters, the performance of pressure feeds, the accuracy and condition of pressure gauges and alarm systems and the physical condition of the above ground structures and terminations. At distribution voltages, periodic inspections check the external condition of distribution cable systems including link pillars, link boxes and service pillars to ensure equipment remains in an acceptable condition.

Energex has initiated the following proactive, targeted programs aimed at known problematic underground distribution assets:

8.3.4.1 Underground Network Demand Replacement

Concentric Neutral Solid Aluminium Conductor (CONSAC) is a legacy aluminium sheathed paper insulated LV cable installed on the network during the 1970's. The aluminium sheath also serves as the neutral conductor in this cable construction. The aluminium sheath is susceptible to corrosion which can lead to open circuit of the neutral and therefore can pose a significant safety risk.

8.3.4.2 Corrosion of Cast Iron Cable Potheads

Cast iron potheads are an obsolete legacy cable termination used to transition from the underground to overhead system. Each core of a multicore cable is terminated through porcelain bushings contained in a cast iron box. A dielectric material, such as hydrocarbon oil or asphalt, is used to fill the box. Corrosion of the outer casing leads to water ingress and potential catastrophic failure of the termination. Due to data quality issues, small populations of these terminations exist and are to be replaced upon discovery.

8.3.4.3 Cable Pit Inspections

Cable pits are underground access chambers used during underground cable installation, housing cable joints, and splitting/routing cables. These concrete cable pits are subject environmental conditions that corrode cable supports and concrete steel reinforcement. Cable joints are also subject to water ingress and heat/overloading deterioration, which may result in an overpressure of the chamber causing the pit lid to dislodge.

8.3.5 Customer Service Line Replacement

Service replacement programs include works as part of an ongoing strategy to ensure compliance with statutory regulations relating to the condition assessment of customer services. Compromised or broken neutral connections can lead to a dangerous rise in potential on the installations earthing system and metallic parts, which can compromise a person's safety. Public shocks are required to be reported to the Electrical Safety Office (ESO) and are monitored against corporate performance targets. This asset class is narrowly performing at an acceptable level against these metrics due to ongoing proactive replacement programs. Energex has also initiated online monitoring of service integrity using in house LV safety monitors and access to smart meter data where applicable. Table 19 lists the number of Neutral Failures over the previous three years.

Table 19 – Number of Energex Neutral Failures by Financial Years

Type of Fault	2019-20	2020-21	2021-22
Neutral Faults	74	99	128

8.3.6 Distribution Transformer Replacement

Distribution transformers are inspected periodically as required by Queensland legislation. Distribution transformers require very little maintenance except for removal of vegetation and animal detritus. They are reactively replaced, due to either electrical failure or poor condition as assessed by ground based inspection. It is generally considered uneconomical to refurbish distribution transformers, and they are routinely scrapped once removed. Replacements are generally undertaken with modern equivalent units.

8.3.7 Distribution Switches (including RMUs) Replacement

These assets are inspected periodically as required by Queensland legislation. All assets require basic cleaning maintenance such as removal of vegetation and animal detritus. HV switches require some mechanical maintenance, mostly related to moving parts. Oil filled Ring Filled Units (RMUs) require some maintenance related to cleaning of oil sludge. SF6 gas filled switches and RMUs require little other maintenance.

LV and HV switches, fuse assets and RMUs are replaced reactively, either on electrical failure or on poor condition as assessed by ground based inspection. Problematic asset types are proactively replaced by targeted programs.

Some refurbishment of components outside of sealed gas chambers is undertaken where economical to do so for in-service assets. It is generally considered uneconomical to refurbish LV and HV switches, fuse carriers and RMUs once removed, and they are routinely scrapped. Replacements are generally undertaken with a modern equivalent unit.

8.4 Substation Primary Plant

8.4.1 Power Transformer Replacement and Refurbishment

Asset condition and failure consequence risks (safety, customer reliability, environmental and business) are regularly assessed for each individual transformer. This begins with a “Health Index” (HI) developed to represent asset condition. A higher HI value represents a more degraded asset, with corresponding higher likelihood of failure. In turn, this reflects as a higher likelihood or inability to achieve the basic customer energy delivery service. Energex considers assets for replacement when HI reaches 7.5. The Asset Management Plan documents the basis of the condition analysis and derivation of Health Index. Energex employs CBRM modelling to identify the poorest condition assets. The oldest substation transformers in the population that have exceeded their technical life are also considered as potential candidates for replacement to avoid an unsustainable build-up of exceptionally aged assets.

Replacement of potential candidate assets is subsequently considered based on network requirements and in alignment with other network drivers such as augmentation and customer requested works to ensure the final option to address the identified limitation is the most cost effective from a whole-of-network perspective. The Energex risk framework is applied to prioritise asset replacement at a program level within financial and resource constraints.

8.4.2 Circuit Breaker, and Switchboard Replacement and Refurbishment

Substation circuit breakers and reclosers condition and failure consequence risks (safety, customer reliability, environmental and business) are regularly assessed for each individual substation asset. This begins with a “Health Index” (HI) developed to represent asset condition. A higher HI value represents a more degraded asset, with corresponding higher likelihood of failure. In turn, this reflects as a higher likelihood of inability to achieve the basic customer energy delivery service. Energex considers assets as potential candidates for replacement when HI reaches 7.5. The Asset Management Plan for Circuit Breakers and Reclosers documents the basis of the condition analysis and derivation of the HI, using CBRM modelling to identify the poorest condition assets. The Energex risk framework is applied to prioritise asset replacement at a program level within financial and resource constraints.

Reclosers are a low cost item of plant used on lines in the distribution network where they are generally replaced on failure. Reclosers are also used in smaller substations as a low-cost circuit breaker alternative where they are managed similarly to circuit breakers.

Line reclosers are visually inspected periodically, as required by Queensland legislation. No other condition assessment is employed. Once physical indicators (e.g. severe corrosion, excessive oil leakage or loss of gas) develop that establish the recloser is at physical end of life, it is replaced.

Many line reclosers fail in service. Because of the volumes and labour costs involved, it has proven to be uneconomical to refurbish retired reclosers and they are routinely scrapped. Replacements are generally undertaken with a modern equivalent unit.

Modern reclosers require very little maintenance except for periodic battery replacement and removal of vegetation and animal detritus.

8.4.3 Instrument Transformer Replacement and Refurbishment

Instrument transformer's condition and failure consequence risks (safety, customer reliability, environmental and business) are regularly assessed for each individual substation asset. A more degraded asset has a corresponding higher likelihood of failure. This has adverse implications on network protection as well as staff and public safety. In turn, this reflects as a higher likelihood of inability to achieve the basic customer service delivery and a safe network for the Queensland community. Energex considers assets for replacement based on assessed end of technical life, condition and risk. The Energex risk framework is applied to prioritise asset replacement at a program level within financial and resource constraints.

Where practical, timing of replacement is coordinated with other necessary works occurring in the substation to promote works efficiencies.

8.5 Substation Secondary Systems

8.5.1 Protection Relay Replacement Program

Protection relays are condition monitored and older models require regular maintenance. Protection relays react to power system faults and automatically initiate supply de-energisation. Failure consequences are predominantly damage to plant and safety impacts, including loss of ability to respond to power system faults and heightened safety risks due to continued energisation of failed assets. Duplication and redundancy are typically employed to reduce these safety risks, although some older sites retain designs where backup protection does not completely compensate for initial protection asset failure. Due to the potential consequences of relay failure, Energex has adopted a proactive replacement program targeting problematic and near end of life relays.

Wherever possible, replacement of obsolete protection schemes is undertaken with other capital work such as primary plant replacement or augmentation for efficiency reasons. In circumstances where this is not possible, standalone projects for replacement of the obsolete protection schemes are undertaken.

8.5.2 Substation DC Supply Systems

Outcome of a battery failure inside a substation can lead to high safety consequence such as serious injury to Energex personnel and reliability risk consequences such as complete loss of control and protection at a substation. Maintaining the operational reliability of substation DC services is paramount.

Batteries are inspected and tested annually. As the batteries degrade with use and time, component elements are replaced upon failure, while complete battery banks and chargers are replaced on age.

8.6 Other Programs

8.6.1 Vegetation Management

Vegetation encroaching within minimum clearances of overhead powerlines presents safety risks for the public, Energex employees and contract workers. Vegetation in the proximity of overhead powerlines is also a major cause of network outages during storms and high winds.

Energex maintains a comprehensive vegetation management program to minimise the community and field staff safety risk and provide the required network reliability. To manage this risk, we employ the following strategies:

- Cyclic programs, to treat vegetation on all overhead line routes. The cycle times are managed based on species, growth rates and local conditions; as well as
- Reactive spot activities to address localised instances where vegetation is found to be within clearance requirements and is unable to be kept clear until the next cycle - or has been reported for action by customers.

Energex works cooperatively with local councils to reduce risk of vegetation contacting powerlines.

8.6.2 Overhead Network Clearance

Energex has an obligation to meet the minimum clearance standards specified under the Electrical Safety Act (2002) (Qld) and associated regulations. The Fugro Roames™ LiDAR technology was deployed in 2016-17 and has allowed individual identification of conductor span clearance to ground and structure issues for all conductor types except service lines.

The most recent LiDAR overhead network clearance survey commenced in August 2020 on a three-year cycle. Energex has adopted an improved clearance defect identification by using a combined physical LiDAR process and algorithm to identify clearance defects at a corrected ambient temperature of 35°C. The LiDAR overhead network clearance survey was completed and all survey results published by January 2022. Work has commenced on the rectification in accordance to the priority matrix which is risk based and follows the “so far as is reasonably practicable” principle with priority given to high risk areas such as schools & agricultural areas and the level of accessibility of clearance to structure defects. The survey revealed 8,130 clearance issues that require addressing.

8.7 Derating

In some circumstances, asset condition can be managed through reducing the available capacity of the asset (derating) in order to reduce the potential for failure or extend the operational life. For example, reducing the normal cyclic rating of a power transformer due to moisture content. The reduction of available capacity may have an impact on the ability of the network to supply the forecast load either in system normal or contingency configurations and therefore results in a network limitation. Limitations of this nature are managed in alignment to augmentation processes.

Chapter 9

Network Reliability

- Reliability Measures and Standards
- Service Target Performance Incentive Scheme (STPIS)
- High Impact Weather Events
- Guaranteed Service Levels (GSL)
- Worst Performing Distribution Feeders
- Safety Net Target Performance
- Emergency Frequency Control Schemes and Protection Systems

9 Network Reliability

9.1 Reliability Measures and Standards

This section describes Energex's reliability measures and standards. Our network planning and security criteria, when combined with reliability targets, underpins prudent capital investment and operating costs to deliver the appropriate level of service to customers.

Energex uses the industry recognised reliability indices to report and assess the reliability performance of its supply network. The two measures used are:

- System Average Interruption Duration Index (SAIDI). This reliability performance index indicates the total minutes, on average, that the system is unavailable to provide electricity during the reporting period
- System Average Interruption Frequency Index (SAIFI). This reliability performance index indicates the average number of occasions the system is interrupted during the reporting period.

9.1.1 Minimum Service Standard (MSS)

The MSS defines the reliability performance levels required of our network, including both planned and unplanned outages, which guides us to maintain the reliability performance levels where the MSS limits have been met. The MSS limits for both SAIDI and SAIFI are applied separately for each defined distribution feeder category – CBD, Urban, and Short Rural.

The reliability limits are prescribed in Energex's Distribution Authority (DA), No. D07/98, October 2019. Energex is required to use all reasonable endeavours to ensure that it does not exceed the SAIDI and SAIFI limits set out in the Distribution Authority for the relevant financial year. Circumstances beyond the distribution entity's control are generally excluded from the calculation of SAIDI and SAIFI metrics.

Under Energex's DA, exceedance of the same MSS limit in three consecutive financial years is considered a 'systemic failure' and constitutes a breach. The MSS limits for the regulatory control period in Schedule 2 of the Distribution Authority remain flat up to 2025.

9.1.2 Reliability Performance in 2021-22

The normalised results in Table 20 highlight a favourable performance against MSS for all of Energex's network performance measures in 2021-22.

Table 20 – Annual Normalised Reliability Performance Compared to MSS Limits

	Feeder Category	2020-21 Actual	2021-22 Actual	2021-25 ³⁷ MSS Limits
SAIDI (mins)	CBD	8.07	4.91	15
	Urban	70.44	80.38	106
	Short Rural	180.78	202.35	218
SAIFI	CBD	0.085	0.072	0.150
	Urban	0.638	0.647	1.260
	Short Rural	1.331	1.442	2.460

In 2021-22, Energex reliability of supply was favourable to the DA's MSS limits for all performance measures.

Figure 14 depicts the five-year rolling average reliability performance for both SAIDI and SAIFI at whole of regulated network level, which demonstrate continual improvement to 2019-20 but has seen performance in 2020-21 and 2021-22 slightly unfavourable. The dominant reason is impact of severe weather caused by the La Nina atmospheric and oceanic phenomena cycle in 2021-22. Energex's overall duration of MSS outages increased by 8.5% in 2021-22 when compared to 2010-11, while frequency of outages decreased by 24.9% when compared to 2010-11. Overall performances are balanced reflection of the targeted investments made during the last two regulatory control periods towards achieving the regulated MSS standards and changes in weather patterns over large areas of Energex's distribution networks affecting restoration times.

³⁷ A single MSS Limit is set for each feeder category for each Regulatory Control Period

Figure 14 – Annual Network SAIDI and SAIFI Performance Five-year Rolling Average Trend

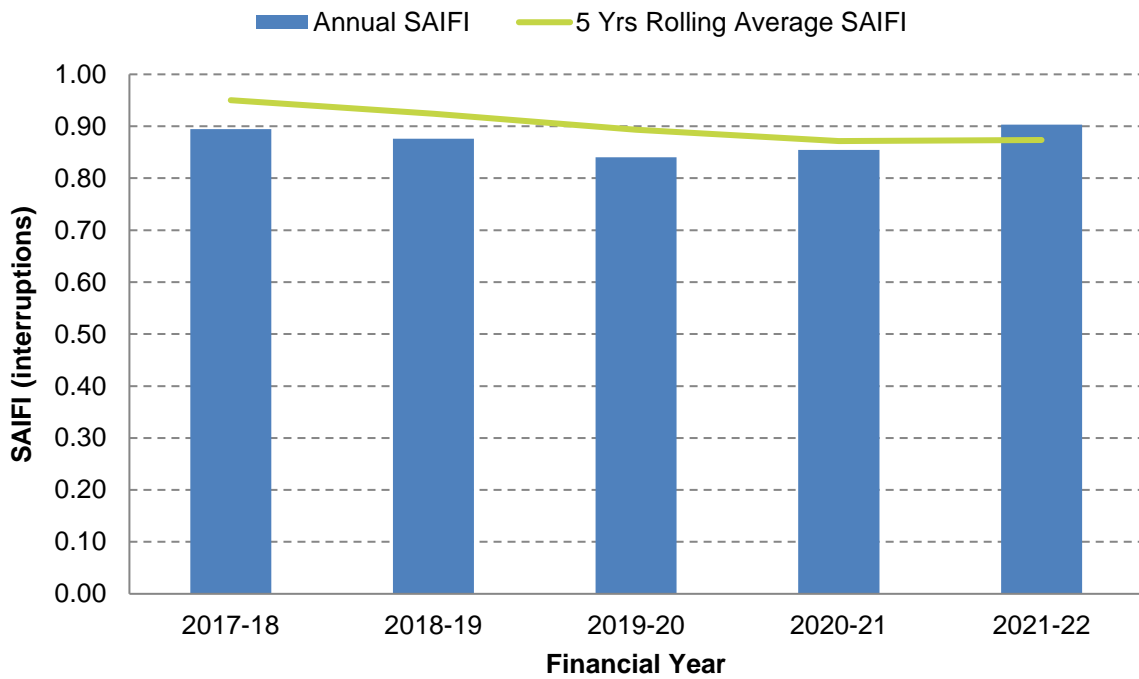
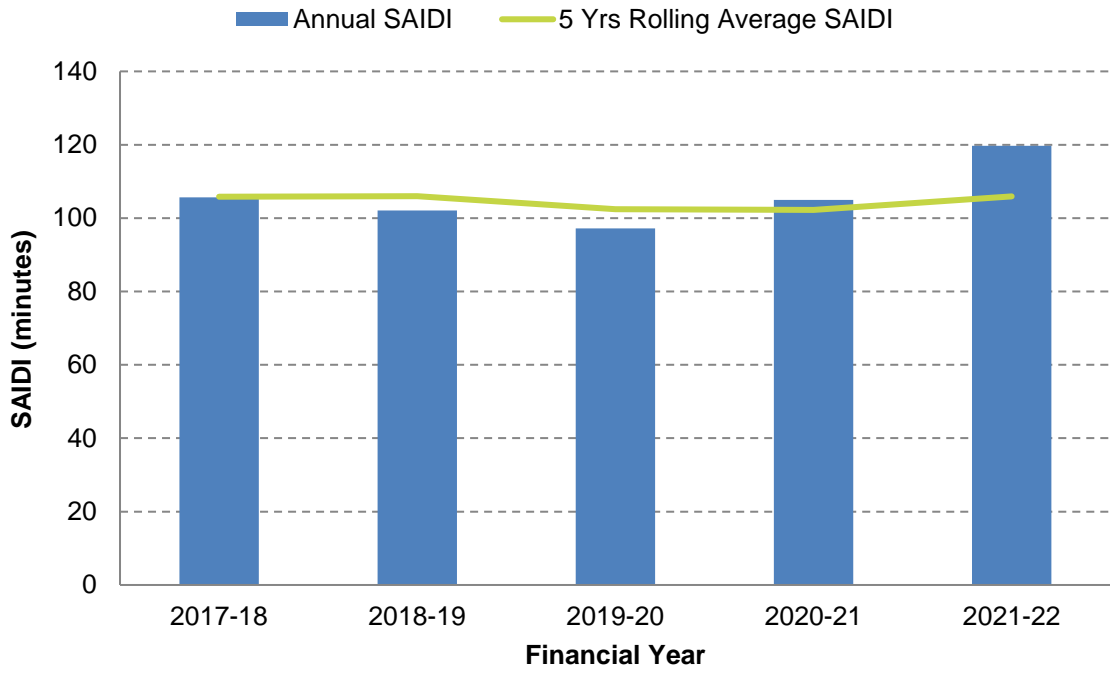

9.1.3 Reliability Compliance Process

Due to inherent statistical variability in reliability performance from year to year, mainly due to adverse weather, simply aiming for the MSS would lead to regular non-compliances and breaches of Energex's DA. To minimise the risk of non-compliance with MSS, Energex has set its internal targets, broken down between planned and unplanned targets, and by region, to ensure that adequate 'room' is allowed for maintenance, refurbishment, customer connections and the corporate initiated works. There is, however, no capex allocated specifically to achieve these internal targets. The internal targets are used as the reference for tracking performance during a year and to put necessary operational measures in place where required and feasible.

9.1.4 Reliability Corrective Actions

As shown in Table 20, Energex met all of its MSS reliability performance targets during 2021-22. This is mainly due to the realisation of previously completed reliability projects targeting poorly performing assets and/or poor reliability areas. A majority of severe weather events during the year have also been excluded under the Major Event Day criteria, or public safety isolations in the event of floods. Energex will continue to implement all reasonable endeavour to remain favourable with the MSS in future years by maintaining a focus on network reliability.

As one of its regulatory obligations under the Distribution Authority, Energex also continues to deliver its Worst Performing Feeder improvement program. While, this program is not targeted towards improving the average system level reliability, it continues to address the reliability issues faced by a smaller cluster of customers supplied by the poorly performing feeders or a section of these feeders.

In addition to the reliability improvement specific works, Energex continues to focus on the reliability outcomes from its asset maintenance, asset replacement and works planning. The asset maintenance and replacement strategies will either continue to have positive influence on reliability performance for this regulatory control period or provide additional benefits on reliability performance in the next regulatory period.

9.2 Service Target Performance Incentive Scheme (STPIS)

The AER's STPIS provides a financial incentive for our organisation to maintain and improve our service performance for our customers. The scheme rewards or penalises a DNSP, in the form of an increment or reduction on Annual Revenue Requirement, for its network performance relative to a series of predetermined service targets. The applicable revenue change is applied in the third year from the regulatory year when the performance outcomes are measured.

The scheme encompasses reliability of supply performance and customer service parameters. The reliability of supply parameters include unplanned SAIDI and SAIFI, applied separately for each feeder category (CBD, Urban and Short Rural).

The incentive rates for the reliability of supply performance parameters of the STPIS are primarily based on the value that customers place on supply reliability (the VCR), energy consumption forecast by feeder type and the regulatory funding model.

The customer service performance target applies to our service area as a whole and is measured through a target percentage of calls being answered within agreed time frames. Service performance targets for all the parameters were determined at the beginning of the regulatory control period.

The AER requests the reporting of annual performance against the STPIS parameters applicable to Energex under its Distribution Determination, via a Regulatory Information Notice (RIN).

Energex's 2021-22 Performance RIN's response included completed templates (and relevant processes, assumptions and methodologies) relating to reliability performance reporting under the STPIS.

More information on Energex's recent RIN submissions can be found on the AER's website [Performance Reporting](#)³⁸

9.2.1 STPIS Results

The normalised results in Table 21 highlight favourable year end performance against the STPIS targets, for five of six network performance measures in 2021-22. As this table presents average duration and the frequency of unplanned supply interruptions, lower numbers indicate stronger results and less interruption to our customers' electricity supply.

Table 21 – Normalised Reliability Performance Compared to STPIS Targets

	Feeder Category	2020-21 Actual	2021-22 Actual	2020-25 ³⁹ STPIS Targets
Unplanned SAIDI (mins)	CBD	4.80	3.14	6.61
	Urban	49.74	57.63	59.85
	Short Rural	128.06	152.61	136.82
Unplanned SAIFI	CBD	0.075	0.064	0.081
	Urban	0.542	0.557	0.640
	Short Rural	1.167	1.262	1.270

In 2021-22, Energex reliability of supply was favourable to all SAIFI STPIS targets, and CBD and Urban SAIDI targets. Short Rural SAIDI was unfavourable to the STPIS target primarily due to an increase in adverse weather and vegetation related outages.

Energex's frequency of overall unplanned outages reduced by 28.6% in 2021-22 compared to the inception of STPIS in 2010, while the duration increased by 12.1%.

Figure 15, Figure 16 and Figure 17 depict the STPIS targets and results for the 2017-22 period. The actuals are the normalised values (i.e. exclusions are applied as per Clause 3.3 of the STPIS).

³⁸ Website: <https://www.aer.gov.au/networks-pipelines/performance-reporting>

³⁹ A single STPIS Target is set for each feeder category for each Regulatory Control Period

Figure 15 – STPIS Targets and Results for Unplanned CBD

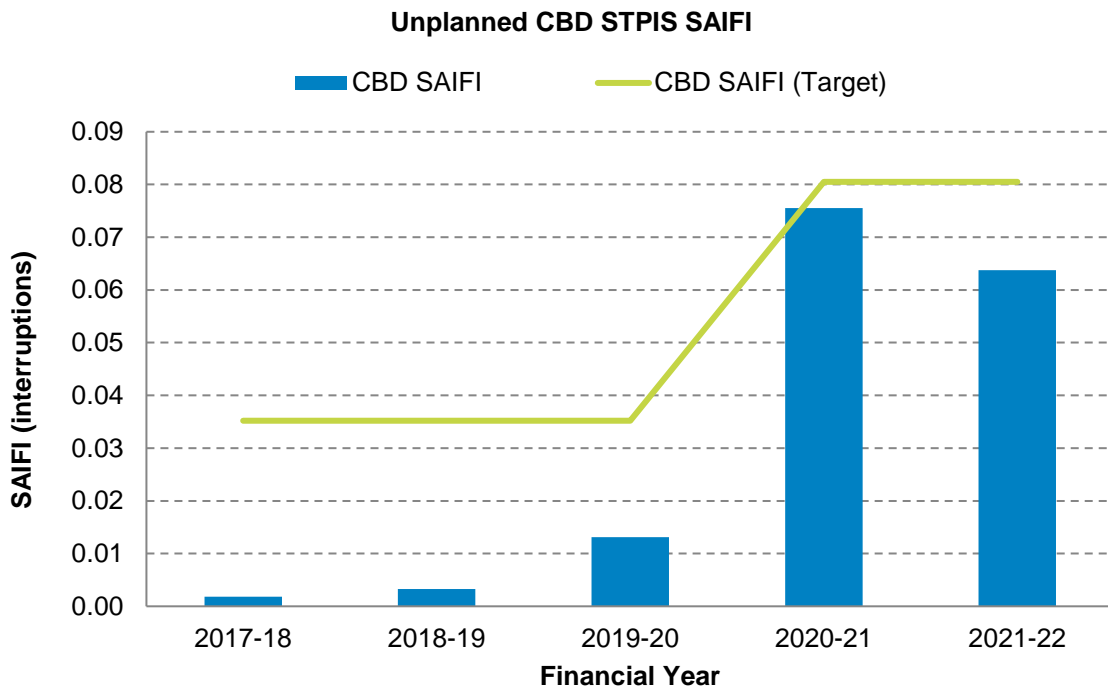
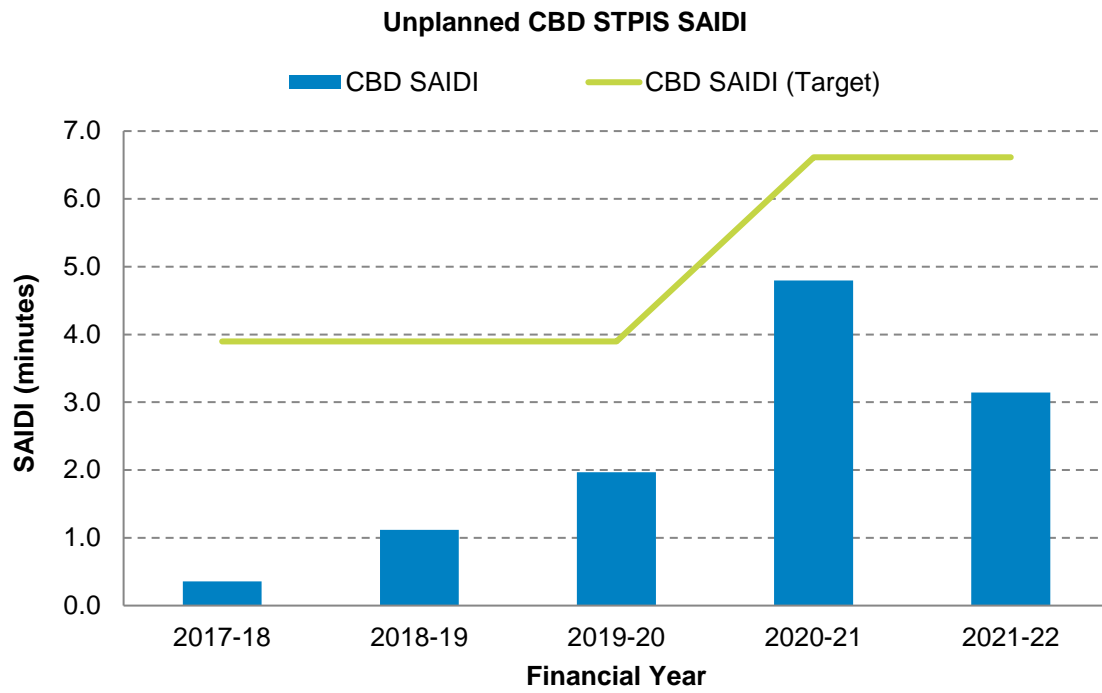

Figure 16 – STPIS Targets and Results for Unplanned Urban

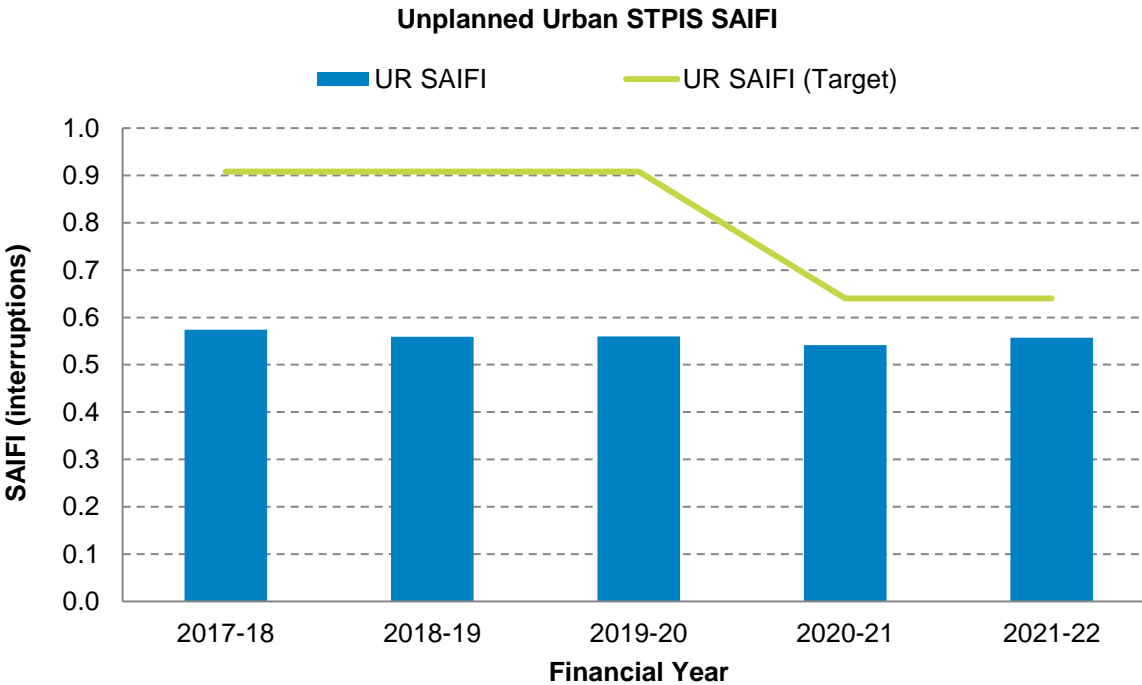
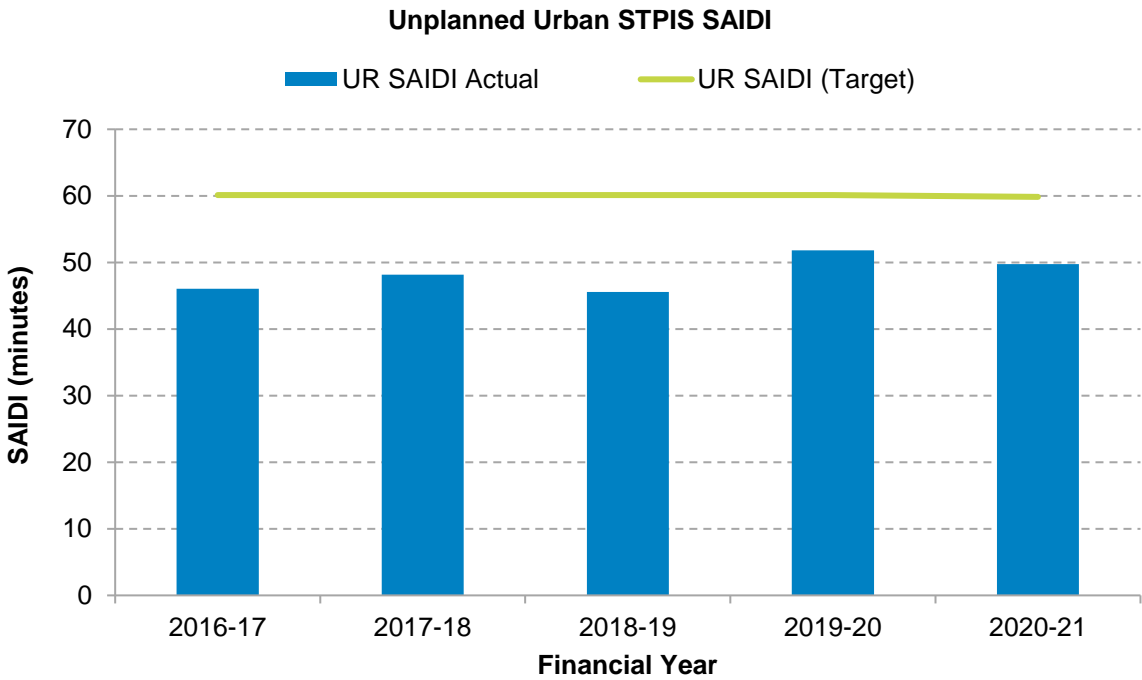
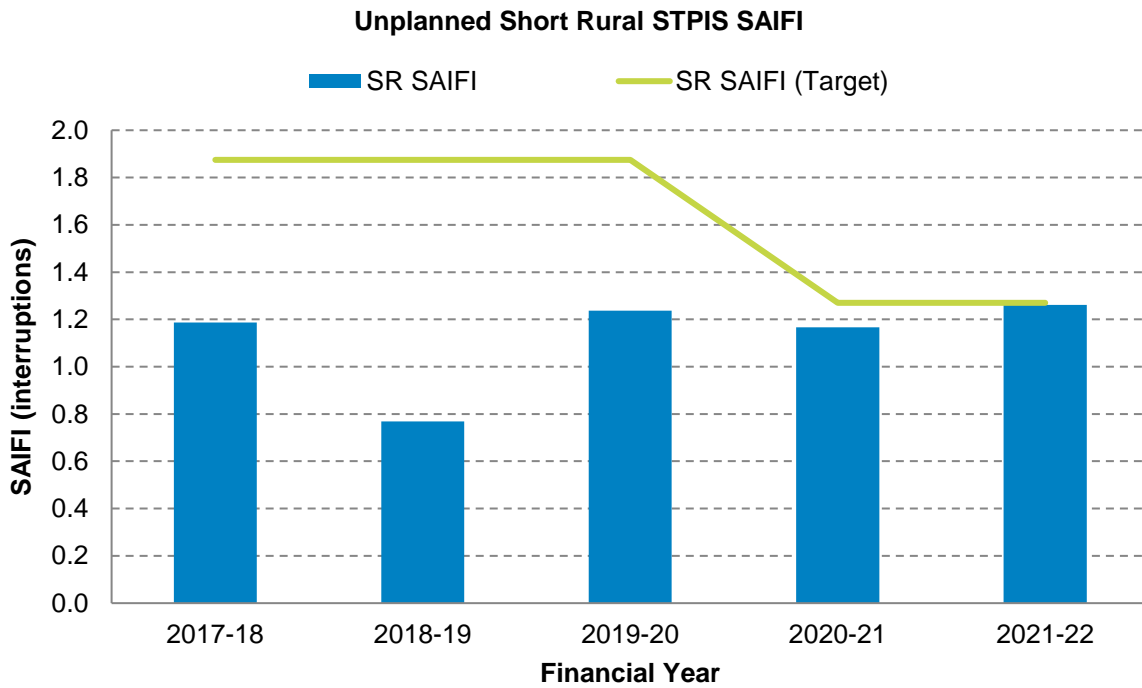
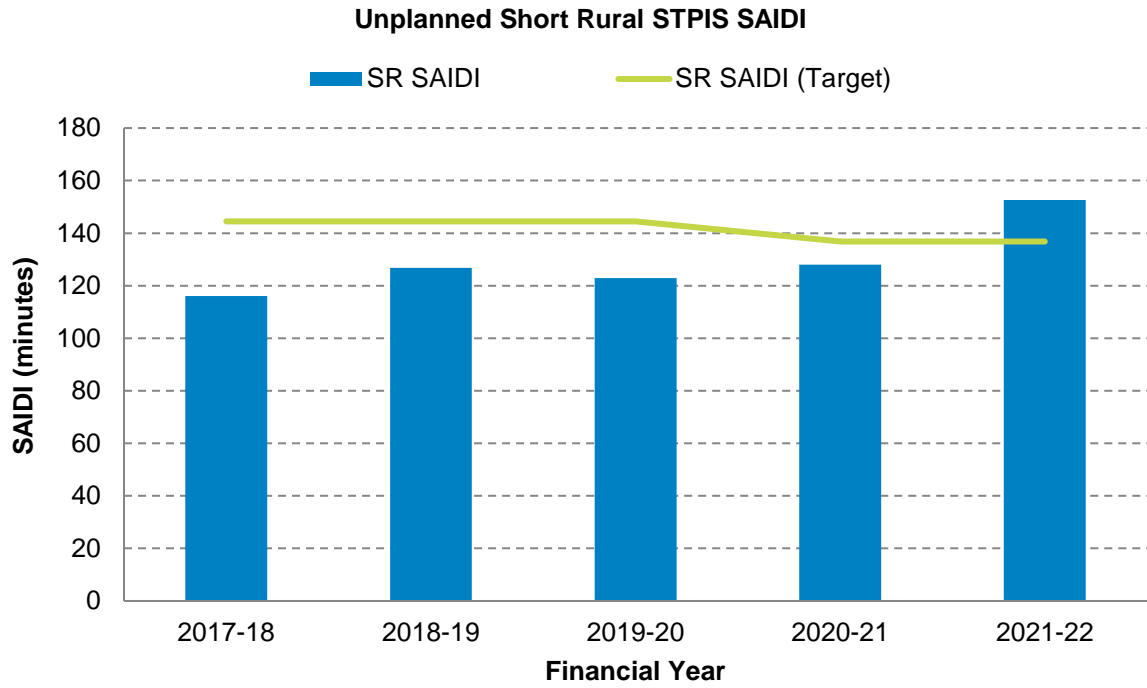

Figure 17 – STPIS Targets and Results for Unplanned Short Rural



9.3 High Impact Weather Events

Energex is conscious that its responses to emergency events, particularly those driven by weather, are delivered in an environment of continually increasing need and expectation, both from customers and community stakeholders. More than ever, our response must consider the increasing customer dependency on electricity as technology and appliances become more sophisticated and economic activity becomes more reliant on e-commerce.

Energex's response priorities in order of importance are:

- Ensuring personal safety - both public and Energex employees
- Protecting equipment and infrastructure from damage
- Efficient supply restoration - including meeting communication requirements of customers and emergency service agencies.

Energex plans for the occurrence of extreme weather events and has developed the following plans which are available at our website [Company Reports & Plans](#)⁴⁰.

- Natural Hazards Management Plan (expansion of the previously Summer Preparedness Plan)
- Bushfire Risk Management Plan.

As further commitment to these priorities and the communities we serve, Energex has established a dedicated team to lead Emergency Planning and Response on behalf of the distribution network. This team will focus on key priorities to further optimise our response capability being emergency planning, preparation, response and recovery.

During the reporting period, the Energex distribution network was exposed to four severe storms impacting the network and subsequently requiring an increased level of response from field and support groups. These severe storms impacted a total of 258,239 customers in the South-East Queensland.

Energex regularly conducts detailed reviews of all escalated response events to ensure it confirms the effectiveness of processes and identifies opportunities to improve the safe and timely restoration for the community. To better enable our network to cope with emergency events, a number of preparation exercises are carried out throughout the year in preparation for the summer storm season, bushfire and floods as outlined in detailed in the sub-sections below.

The damage assessment process has been significantly enhanced through greater utilisation of technology including the use of mobile devices incorporating geospatial and asset data capture capability. The combined process produces more accurate and timely field data for the planning, restoration and recovery, which supports improved response times and savings to Energex and the local economy.

9.3.1 Summer Preparedness

Energex conducts annual preparations prior to each summer storm season to provide its customers in South-East Queensland with a reliable network that minimises interruptions during extreme weather conditions. Where disruptions occur, we plan to keep the community fully informed and respond as quickly as possible to restore supply safely. Preparations include the review of response programs and processes, resourcing and ongoing network related capital and operating works prior to summer to

⁴⁰ Website: <http://www.energex.com.au/about-us/company-information/company-policies-And-reports>

achieve a secure and reliable network. Comprehensive post implementation reviews are also conducted to identify further opportunities to enhance our processes, plans, technology, people development and overall response capability. These types of reviews are critical as part of continually meeting stakeholder expectations and reducing the negative impact of large-scale disasters on the Queensland community.

Key activities undertaken in preparation for severe weather events include but is not limited to:

- Construction of new equipment to a standard that provides increased resilience and reduces the impact severe weather events have on the continuity of supply to our customer
- Maintain a significant mobile generation and mobile substation fleet that supports the restoration of supply following severe weather events
- Ensure an appropriate inventory of critical spare equipment is on hand at strategic locations to support rebuild and restoration efforts
- Routine inspection and maintenance of vegetation in proximity to overhead powerlines that may contribute to failures of the asset and the creation of a safety risk to the community
- Routine maintenance and inspection of substation equipment, overhead powerlines and poles, inspection of waterway crossings and a range of other network assets
- Prior to the annual storm season critical overhead powerlines are aerially inspected for any potential conditional defects that may contribute to the risk of failure
- Interagency relationships and cooperation are maintained through representation and collaboration with both the State and Local Disaster Management Committees across the state
- Formalise relationships with other Distribution Entities in support of response and recovery efforts during and post severe weather events through a Memorandum of Understanding
- Implementation of a highly trained expert Emergency Management Team that provide central coordination and management of the response and recovery following a severe weather event
- Training in the preparation of formal restoration plans that provides prioritised focus on restoring services to critical community infrastructure such as hospitals, aged care facilities, evacuation centres, shopping centres, fuel stations, sewerage and water treatment plants, major traffic intersections, etc.
- Community Engagement in preparation for and during the post event recovery is a strong focus and is provided through a combination of our customer contact centres, social and mainstream media platforms and our community outreach teams that are deployed into the affected communities.

9.3.2 Bushfire Management

Energex reviews and updates the Bushfire Management Plan annually. The plan is published in August each year and contains a list of programs and initiatives to reduce bushfire risks impacted by the network. Energex has on-going asset replacement and improvement programs in high bushfire risk areas. Energex also undertakes pre-summer inspections in bushfire risk areas and rectifies the high priority defects identified on the patrols. It also reports and investigates suspected asset related bushfires.

Key activities undertaken in preparation for Bushfire Events include but is not limited to:

- Mapping through our Geospatial Information System (GIS) to identify the network equipment installed in bushfire hazard areas
- Engaging a dedicated weather service provider to provide specialist weather advice on forecast weather patterns including heatwaves, storms and lightning levels which is overlaid with

Sentinel satellite fire detection information and network asset locational information to inform event management team

- Maintain a significant mobile generation and mobile substation fleet that supports the restoration of supply following significant network damage resulting from bushfire events
- Implementing a vegetation management strategy to reduce fuel load in proximity to powerline poles and the potential for vegetation contact with overhead powerlines
- Routine maintenance and inspection of overhead powerlines and poles and a range of other network assets. This program extends to privately owned powerline assets where they make connection to the utility assets
- Interagency relationships and cooperation are maintained through representation and collaboration with the Local and State Disaster and Bushfire Management Committees across the state
- Exploration of bushfire risk modelling by industry recognised academic experts to improve the identification and management of the ignition and consequential damage risk to assets
- Conservative operational work practice during periods of heightened bushfire danger including but not limited to:
 - Limited offroad use of motor vehicles and machinery that may trigger an ignition event from the high operating temperatures of exhaust systems
 - Special consideration when using equipment such as generators, chainsaws, brush cutters, metal cutting or welding to determine fire start risk and the appropriate controls to reduce that ignition risk.
- Capital investment to reduce the likelihood of fire starts from electrical assets and to reduce the risk of network asset damage from external fires. Examples of the range of initiatives undertaken include but is not limited to:
 - Line refurbishment programs– such as replacement of aged (or corroded) conductor, installation of insulated/covered conductors
 - Lines defect remediation – repair and remediation of defects identified through asset inspection, such as cross-arms, insulators tie wires etc.
 - Programs for condemned pole replacement
 - Customer Service line replacement programs
 - The transition to a range of updated equipment standards as new equipment is installed
 - Trialling and development of a range of fire resilient pole materials/technologies (such as composite fibre) along with the ongoing use of concrete and steel rebuffed poles in bushfire prone areas
 - Ongoing research and development and trials of fire-resistant coatings such as fireproof paint and fireproof wraps for wood poles in fire prone areas
 - Ongoing research into advanced protection systems that limit the potential for network equipment failures resulting in a bushfire ignition.

9.3.3 Flood Resilience

Following the 2010-11 floods which impacted the regions of Brisbane, Logan, Ipswich, Gympie and the Lockyer Valley Energex updated its planning guidelines for installing infrastructure in flood prone areas and reviewed flood resilience measures. Flood resilient electrical infrastructure is important, not least because other essential services needed during and after a flood depend on electricity to operate. A

number of flood resilience projects at CBD substations and several zone and bulk substations have been completed and operational plans incorporating the dispatch of generators and flood isolation switching have been reviewed and updated for the Brisbane, Logan, Bremer and Nerang River systems.

Key activities undertaken in preparation for flooding events include but is not limited to:

- Mapping through our Geospatial Information System to identify the network equipment installed in flood prone areas
- Modernisation of flood modelling through Geospatial Information Systems as a step toward a dynamic risk assessment and agile response approach
- Engaging a dedicated weather service provider to provide specialist weather advice on forecast weather patterns likely to cause flooding
- Interagency relationships and cooperation are maintained through representation and collaboration with both the State and Local Disaster Management Committees/Centres across the state
- Standardisation of ground mounted equipment such as switches, distribution substations and pillars enable efficient replacement when inundation causes irreparable damage
- Memoranda of Understanding with other agencies including local councils along with weather service providers like the Bureau of Meteorology providing information on river and creek levels along with historical inundation contouring to inform local flood management plans
- Development and annual version review of local flood management plans identify the electrical equipment and customer installations at risk of inundation and allow proactive precautionary isolation of electrical supply to manage inundation risk
- Capital investment to increase resilience and reduce the inundation risk to electrical assets are made through an annual program of work that include but is not limited to:
 - Relocation of ground mount equipment in flood prone areas
 - Installation of additional switching points on the network to reduce the impact of preventative isolation on the continuity of supply to customers
 - Providing additional drainage in large substations where groundwater presents an increased risk to electrical equipment
 - Developing flood barricades for large substations where overland water presents a risk of inundation within the control buildings.
- Standardisation of the post flood asset condition assessment and maintenance repair activities on inundated equipment to expediate the return to service where repair is possible
- Construction new equipment is to a higher standard to increase resilience and reduce the impact floods events have on the continuity of supply to our customers
- Maintain a significant mobile generation and mobile substation fleet that supports the restoration of supply following severe weather events
- Ensure an appropriate inventory of critical spare equipment is on hand at strategic locations to support rebuild and restoration efforts
- Standardisation of installed equipment that supports an efficient retrofit replacement for assets irreparably damaged as a result of inundation.

9.4 Guaranteed Service Levels (GSL)

Section 2.3 of the Electricity Distribution Network Code (EDNC) specifies a range of Guaranteed Service Levels (GSLs) that DNSPs must provide to their small customers. The GSLs are notified by the Queensland Competition Authority (QCA) through the code. Where we do not meet these GSLs we pay a financial rebate to the customer.

GSLs are applied by the type of feeder supplying a customer with limits appropriate to the type of GSL as outlined below in Table 22. Some specific exemptions to these requirements can apply. For example, we do not need to pay a GSL for an interruption to a small customer's premises within a region affected by a natural disaster (as defined in the EDNC).

Table 22 – GSL Limits Applied by Feeder Type

EDNC	GSL	CBD feeder	Urban feeder	Short rural feeder
Clause 2.3.3	Wrongful disconnections (Wrongfully disconnect a small customer)	Applies to all feeders equally		
Clause 2.3.4	Connections (Connection not provided)	On business day agreed with customer. Applies to all feeders equally		
Clause 2.3.5	Reconnections (Reconnection not provided within the required time)	If requested before 12.00pm - same business day. Otherwise next business day		
Clause 2.3.7	Appointments (Failure to attend specific appointments on time)	On business day agreed with customer. Applies to all feeders equally		
Clause 2.3.8	Planned Interruptions (Notice of a planned interruption to supply not given)	4 business days as defined in Division 6 of the NERR under Rule 90 (1). Applies to all feeders equally		
Clause 2.3.9(a)(i)	Reliability – Interruption Duration (If an outage lasts longer than...)	8 hours	18 hours	18 hours
Clause 2.3.9(a)(ii)	Reliability – Interruption Frequency (A customer experiences equal or more interruptions in a financial year)	10	10	16

9.4.1 Automated GSL Payment

The EDNC requires that a DNSP uses its best endeavours to automatically remit a GSL payment to an eligible customer. Customers receive the payment for most GSLs within one month of confirmation. However, in the case of Interruption Frequency, the GSL payments will be paid to the currently known customer once the requisite number of interruptions has occurred. Table 23 shows the number of claims paid in 2021-22.

Table 23 – GSLs Claims Paid 2021-22

GSL	Number Paid	Amount Paid
Wrongful disconnections	17	\$2,635
Connection not provided by the agreed date	926	\$343,666
Reconnection not provided within the required time	25	\$3,472
Failure to attend appointments on time	128	\$7,936
Notice of a planned interruption to supply not given	276	\$10,074
Interruption duration GSL	3,760	\$466,240
Interruption frequency GSL	0	\$0
Total	5,132	\$834,023

9.5 Worst Performing Distribution Feeders

In accordance with Clause 11 of the Distribution Authority No. D07/98, Energex continues to monitor the worst performing distribution feeders on its distribution network and report on their performance. Under the authority, Energex is also required to implement a program to improve the performance outcomes for the customers served by the worst performing distribution feeders.

In October 2019 the worst performing feeder improvement program criteria set out in Clause 11.2(c) of the Distribution Authority No. D07/98 were amended and are outlined below:

Clause 11. Improvement Programs

11.2(c) The worst performing feeder improvement program will apply to any distribution feeder that meets the following criteria:

- (i) The distribution feeder is in the worst 5% of the network's distribution HV (High Voltage) feeders, based on its three-year average SAIDI/SAIFI performance; and*
- (ii) The distribution HV feeder's SAIDI/SAIFI outcome is 200% or more of the MSS SAIDI/SAIFI limit applicable to that category of feeder.*

The list of our worst performing distribution feeders, as defined by Clause 11.2(c) of the Distribution Authority No. D07/98 up to June 2022, has been provided in Appendix F. Energex's worst performing distribution feeder assessment for 2021-22 is summarised below:

- 3% of Energex's distribution feeders meet the worst performing feeder improvement program criteria based on three-year average performance up to June 2022 (67 distribution feeders in total – zero CBD, 16 Urban and 51 Short Rural).
- The 67 distribution feeders meeting the worst performing feeder improvement program criteria supply 3.11% of the Energex's customer total.
- 42 of the reported worst performing distribution feeders have carried over from the list from the 2020-21 reporting period.

Table 24 below shows the comparative average three-year averages of SAIDI/SAFI for the reported worst performing distribution feeders across the feeder categories for 2021-22.

Table 24 – 2021-22 Worst Performing Feeder List – Current Performance

Feeder Category	3 Year Average Feeder SAIDI (mins)	3 Year Average Feeder SAIFI (int.)
Urban	803	5.03
Short Rural	707	3.97

9.5.1 Details of worst performing distribution feeders reported from 2021-22

CBD feeders:

- No feeders in the CBD category have met the worst performing distribution feeder criteria.

Urban feeders

- The Urban worst performing distribution feeder list consists of 16 feeders. From the total of 16 feeders seven met only the worst performing distribution feeder SAIDI criteria, four feeders met only the SAIFI criteria and five met both the SAIDI and SAIFI criteria.

Short Rural feeders

- The Short Rural worst performing feeder list consists of 51 feeders. From the total of 51 feeders 35 met only the worst performing distribution SAIDI criteria, five only met the SAIFI criteria and 11 met both the SAIDI and SAIFI criteria.

A full report on Energex’s worst performing distribution feeders based on 2021-22 performance is available in Appendix F.

9.5.2 Review of Worst Performing Distribution Feeders from 2020-21

- 71% of the 56 worst performing feeders identified in 2020-21 saw an improvement in their annual SAIDI as of June 2022. 16 of those feeders are now favourable to the June 2022 MSS SAIDI limits.
- 54% of the 56 worst performing feeders identified in 2020-21 saw an improvement in their annual SAIFI as of June 2022. 23 of those feeders are now favourable to the June 2022 MSS SAIFI limits.

During the 2021-22 period Energex completed detailed engineering reviews for 19 worst performing distribution feeders. The feeder reviews included detailed analysis of different types of outages (planned and unplanned). 19 feeder reliability improvement projects have been raised following the feeder reviews.

9.5.3 Worst Performing Feeder Improvement Program

Consistent with the 2015-2020 regulatory term, Energex only sought limited capex for the worst performing feeder improvement program from the AER for the 2020-25 regulatory control period. We are ensuring that the investment in the worst performing feeder improvement program is prudently spread across different feeders that meet the Distribution Authority No. D07/98 improvement program Clause 11 criteria.

The reliability improvement solutions identified from the worst performing distribution feeder reviews conducted in the 2015-20 regulatory period have mainly included moderate capital investment options and we expect this to continue in this regulatory period. These mainly included installation of new Automatic Circuit Reclosers, Sectionalisers, Remote Controlled Gas Switches and also relocation and/or replacement of switching devices. Some of the higher capital investment options have included re-conductoring, covered conductors and overhead tie points. Energex will continue reviews of its worst performing distribution feeders during 2022-23.

The overall approach for the worst performing feeder performance improvement includes the following in order of preference and affordability:

1. Improved network operation by:
 - investigating to determine predominant outage cause
 - implementing reliability or operational improvements identified through the investigation of any unforeseen major incidents
 - improving fault-finding procedures with improved staff-resource training and availability, and line access
 - improving availability of information to field staff to assist fault-finding, which could include communications, data management and availability of accurate maps and equipment
 - planning for known contingency risks until permanent solutions are available
 - improving and optimising management of planned works.
2. Prioritisation of preventive-corrective maintenance by:
 - scheduling asset inspection and defect management to poorly performing assets early in the cycle
 - scheduling worst performing distribution feeders first on the vegetation management cycle
 - undertaking wildlife mitigation (e.g. birds, snakes, possums, frogs) such as pole guards, conductor configuration and spacing, and line markers for worst performing distribution feeders.
3. Augmentation and refurbishment through capex by:
 - refurbishing or replacing conditioned assets (for both powerlines and substations).

9.6 Safety Net Target Performance

In accordance with Section 10 of the Distribution Authority No. D07/98, Energex will ensure, to the extent reasonably practicable, that we achieve safety net compliance and continue to monitor unplanned outages on our sub-transmission network and report on our performance against Safety Net Targets.

As per Section 10.1, the purpose of the service safety net, is to seek to effectively mitigate the risk of low probability high consequence network outages to avoid unexpected customer hardship and/or

significant community or economic disruption. In 2021-22, there were no events exceeding the service Safety Net targets.

9.7 Emergency Frequency Control Schemes and Protection Systems

The Energex network is predominately comprised of centralised under frequency protection schemes. Centralised schemes are those that have common measuring relays that have one or more under frequency stages, assertion of a stage is sent to a circuit breaker via a physical selector switch. The mode of these schemes are static and cannot be simply controlled remotely.

The Energex Under Frequency Loading Shedding (UFLS) schemes are unaware of the load current on the feeders being controlled, these feeders operate solely based on under frequency. To meet the requirements of load under control, Energex UFLS schemes will progressively be enhanced to be load aware (prevent tripping when feeders are acting as a source). Majority of Energex distribution feeders have been assigned to its UFLS scheme. Under Frequency Load Shedding protection schemes are the only wide area protection or control scheme that are expected to have capability of leading to cascading outages or major supply disruptions.

Chapter 10

Power Quality

- Quality of Supply Process
- Customer Experience
- Power Quality Supply Standards, Codes Standards and Guidelines
- Power Quality Performance
- Power Quality Ongoing Challenges and Corrective Actions

10 Power Quality

The quality of network power affects both the customer experience, and the efficiency and stability of the network. This section covers two related, but distinct areas which are Quality of Supply (QoS) and Power Quality (PQ). QoS is a measure of the customer-initiated requests for Energex to investigate perceived issues with the quality of the supply. PQ is the measure of compliance of measured system wide network conditions with defined parameter limits.

10.1 Quality of Supply Processes

Energex responds to customer voltage enquiries / complaints by carrying out relevant voltage investigations which may include the installation of temporary voltage monitoring equipment on the network and at customers' premises. This data is used in conjunction with existing network monitors for analysis to determine what remediation is necessary.

Due to the complexity of the network and the large number of sites involved, the management of specific quality of supply issues presents many challenges. To address these challenges, a proactive and systematic approach shown in Figure 18 is being adopted. This involves:

- Establishing suitable data acquisition (monitoring) and reporting systems to identify problem areas
- Establishing objective measures and supporting systems for prioritising remedial works
- Developing network models down to the LV that allow problem areas to be predicted
- Implementing and tracking improvements from remediation programs
- Measuring results to refine the network model and remediation options.

Figure 18 – Systematic Approach to Voltage Management

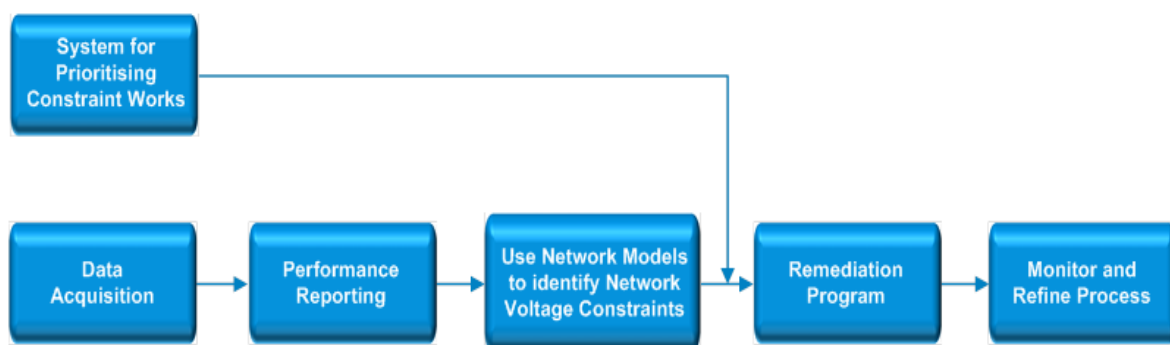

Energex has developed a series of reports from the Distribution Monitoring Analytics (DMA) platform to identify and prioritise power quality issues. The DMA platform also enables the large volume of power quality time series data captured from the monitoring devices to be more easily analysed with possible causes such as solar PV penetration and network topology. Energex takes a pro-active approach to identify possible sites where PQ and QoS issues may exist. Sites that exceed limits are prioritised and

emailed to PQ Subject Matter Experts (SMEs) daily for action. PQ SMEs then work with Customer Service and Operations teams to rectify issues before they impact customers equipment and/or safety.

10.2 Customer Experience

Energex has been traditionally tracking the customer experience by the number of QoS enquiries it receives. QoS enquiries occur when a customer contacts Energex with a concern that their supply may not be meeting the standards. Figure 19 shows that the overall number of enquiries, on a normalised basis per 10,000 customers per month, varies significantly from month to month and displays some seasonality, being higher over the summer periods. However, the overall long-term trend measured over the last 5 years shows a slight decline in 2021-22.

Figure 19 – Quality of Supply Enquiries per 10,000 Customers

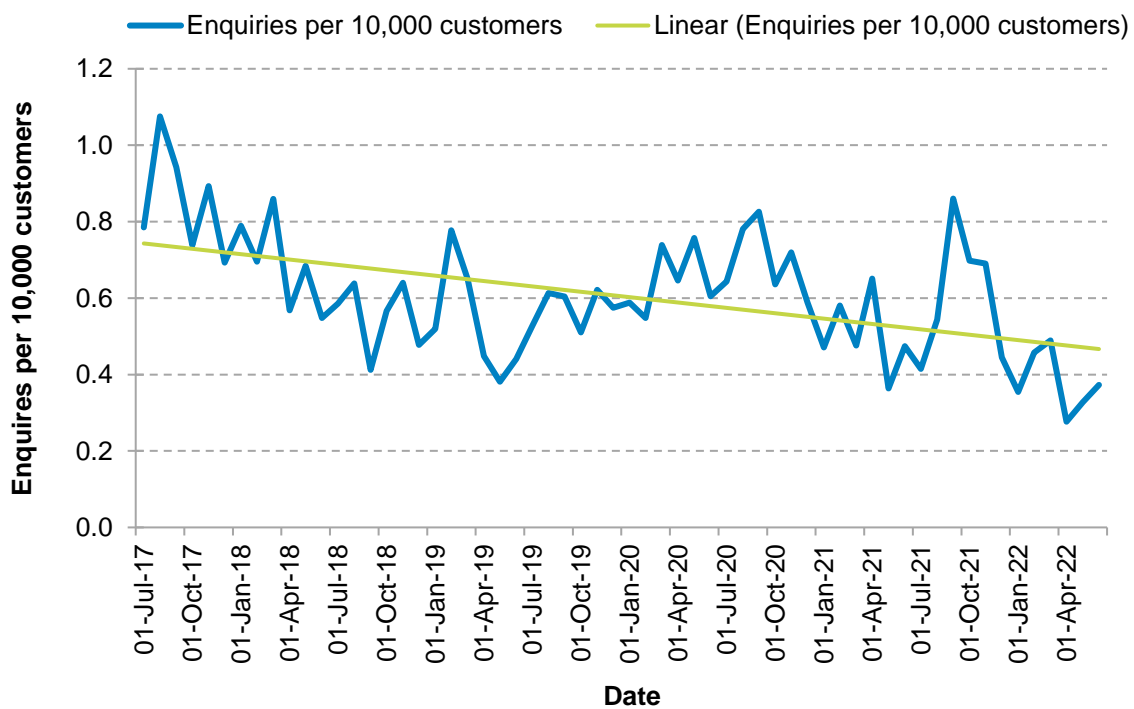

Figure 20 shows a breakdown of the enquiries received by the reported symptoms over the last 12 months, with the largest identifiable category at 46%, related to solar PV issues. These are usually associated with customer installations where solar PV inverters could not export without raising voltages above statutory limits. Although inverters are designed to disconnect when voltage rises excessively, regular occurrences of this reduce the level of electricity exported and can often cause voltage fluctuations and customer complaints.

Figure 21 shows the number of Quality of Supply enquiries received from 2017–2022. The QoS enquiries can mainly be categorised into low voltage, voltage swell, voltage spike, solar PV related and other queries. Solar PV related queries have continued to dominate the QoS queries for the last five years, and this clearly indicates growing number of PV system connected on the distribution network.

Figure 20 – Quality of Supply Enquiries by Category 2021-22

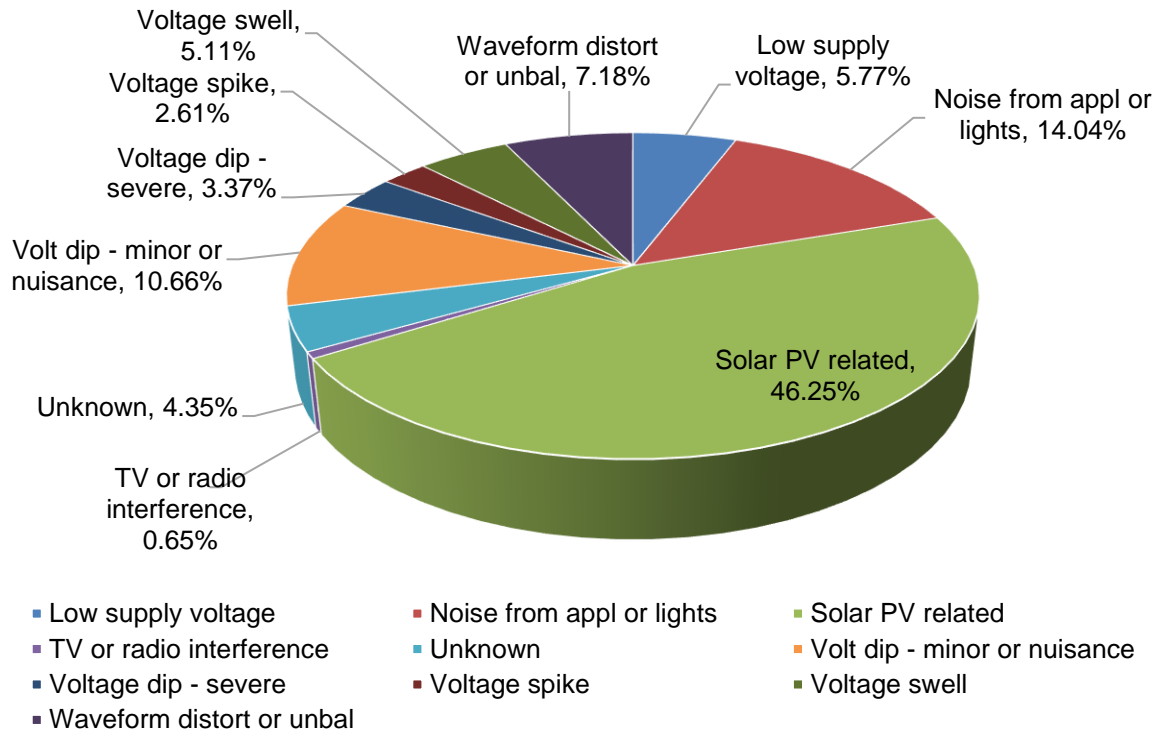
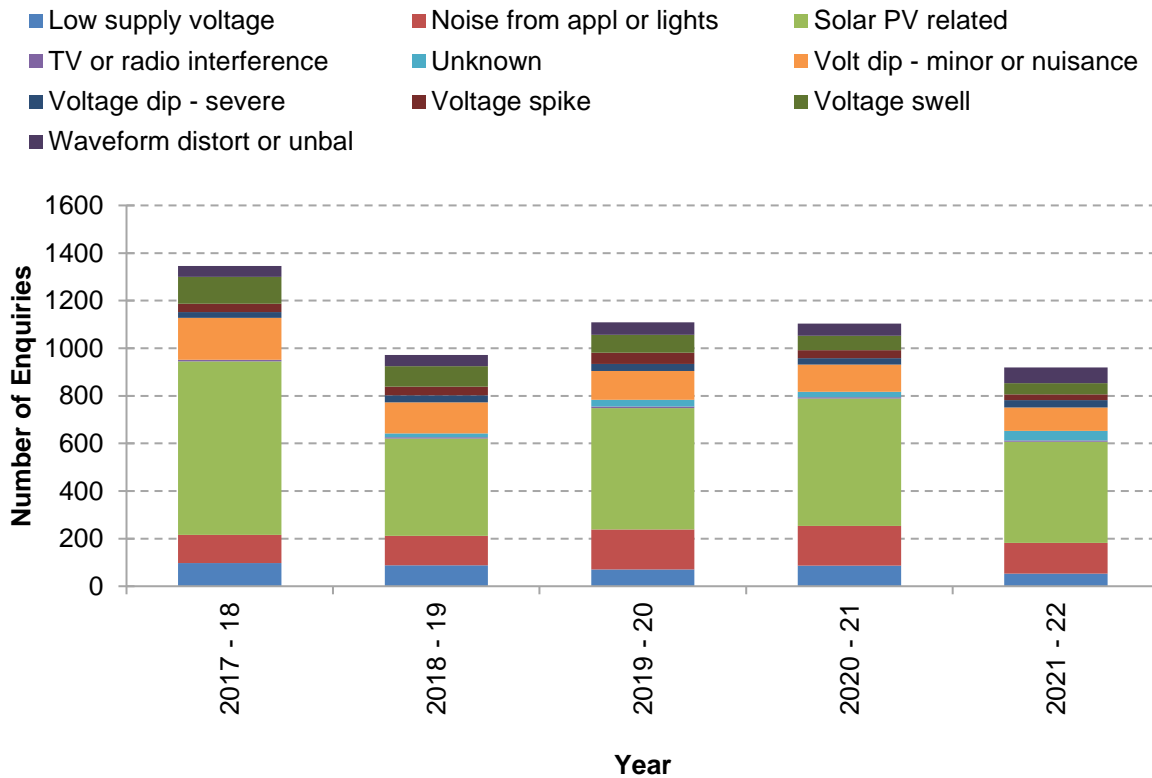
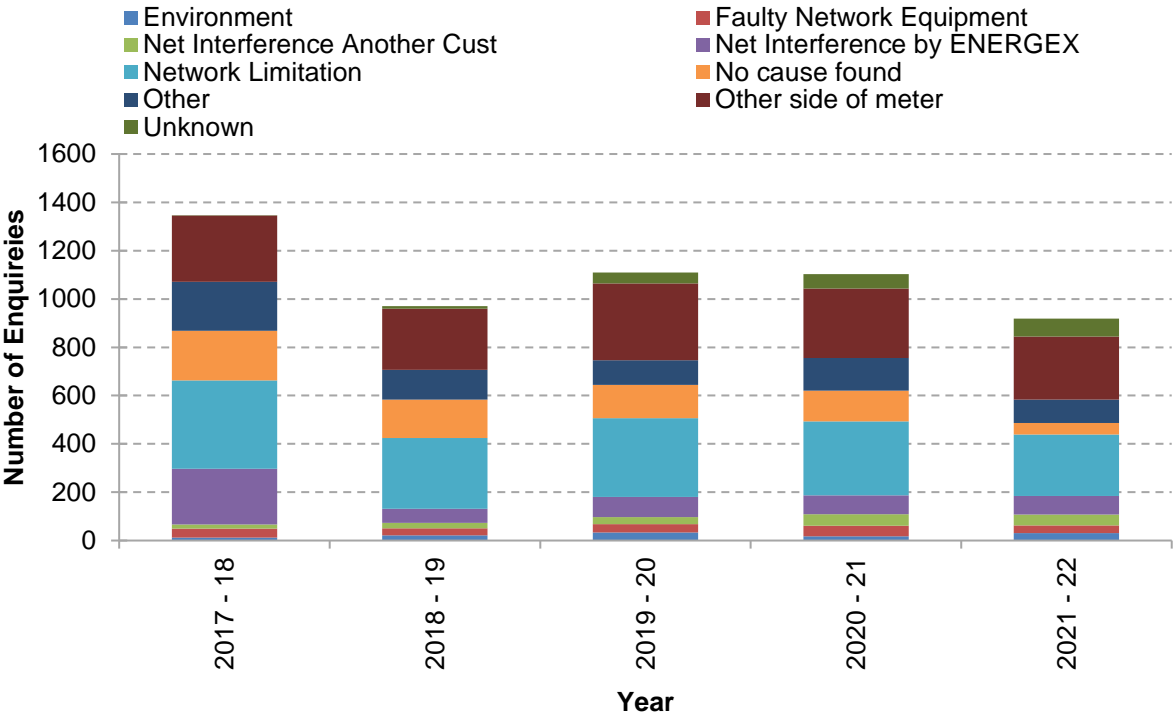

Figure 21 – Quality of Supply Enquiries per Year



The causes at enquiry close out for QoS enquiries is shown in Figure 22. The data shows that 39.5% of the enquiries to date were due to a network issue, no fault found 5.22% and the fault was on the customers side of the connection, 28.37%. Considering High Voltage (HV), Low Voltage (LV) and Solar Enquiries make up majority of the customer enquiries, the network solutions range from low cost solutions of balancing the LV Network and changing the tap position on the transformer, to more costly DNSPs solutions of upgrading the customers service conductors and upgrading the LV network conductors to accommodate the extra solar generation. Some LV networks are reaching greater than 65% penetration of Solar, calculated against the Distribution transformer capacity.

Figure 22 – Quality of Supply Enquiries by Cause at Close Out



10.3 Power Quality Supply Standards, Codes Standards and Guidelines

The Queensland Electricity Regulations and Schedule 5.1 of the NER lists a range of network performance requirements to be achieved by Network Service Providers (NSPs). Accordingly, Energex’s planning policy takes these performance requirements into consideration when considering network developments. The tighter of the limits is applied where there is any overlap between the Regulations and the NER. In October 2017, the Queensland Electricity Regulation was amended to change the Low Voltage (LV) from 415/240V +/-6% to 400/230V +10%/-6% to harmonise with Australian Standard 61000.3.100 and a majority of other Australian States.

Some of the requirements under the regulations/rules are listed below and further defined in Table 25, Table 26, Table 27 and Table 28.

- **Magnitude of Power Frequency Voltage:** During credible contingency events, supply voltages should not rise above the time dependent limits defined in Figure S5.1a.1 of the Rules. (For normal steady state conditions, a requirement of $\pm 6\%$ for Low Voltage and $\pm 5\%$ for High Voltage of 22kV or less is specified in the Electricity Regulations S13)
- **Voltage Fluctuations:** An NSP must maintain voltage fluctuation (flicker) levels in accordance with the limits defined in Figure 1 of Australian Standard AS 2279.4:1991. Although a superseded standard, it is specifically referenced under a Derogation of the Rules (S9.37.12) applicable to Queensland
- **Voltage Harmonic Distortion:** An NSP must use reasonable endeavours to design and operate its network to ensure that the effective harmonic distortion at any point in the network is less than the compatibility levels defined in Table 1 of Australian Standard AS/NZS 61000.3.6:2001
- **Voltage Unbalance:** An NSP has a responsibility to ensure that the average voltage unbalance measured at a connection point should not vary by more than the amount set out in Table S5.1a.1 of the NER Rules.

Table 25 – Allowable Variations from the Relevant Standard Nominal Voltages

Voltage Levels	Electricity Regulations	NER
Low voltage (less than 1kV)	+10/-6% ¹	$\pm 10\%$
Medium voltage (1kV to 22kV)	$\pm 5\%$ ¹	$\pm 10\%$
High voltage (22kV to 132kV)	As Agreed	$\pm 10\%$

¹ Limit is only applicable at customer's terminals.

Table 26 – Allowable Planning Voltage Fluctuation (Flicker) Limits

Voltage Levels	Electricity Regulations	NER
Low voltage (less than 1kV)	Not Specified	Pst= 1.0, Plt=0.8 ($\Delta V/V - 5\%$)
Medium voltage (11kV to 33kV)	Not Specified	Pst= 0.9, Plt=0.8, ($\Delta V/V - 4\%$)
High voltage (33kV to 132kV)	Not Specified	Pst= 0.8, Plt=0.6, ($\Delta V/V - 3\%$)

Table 27 – Allowable Planning Voltage Total Harmonic Distortion Limits

Voltage Levels	Electricity Regulations	NER
Low voltage (less than 1kV)	Not Specified	7.3%
Medium voltage (11kV)	Not Specified	6.6%
Medium voltage (33kV)	Not Specified	4.4%
High voltage (110kV, 132kV)	Not Specified	3%

Table 28 – Allowable Voltage Unbalance Limits

Voltage Levels	Electricity Regulations	NER
Low voltage (less than 1kV)	Not Specified	2.5%
Medium voltage (1kV to 33kV)	Not Specified	2%
High voltage (33kV to 132kV)	Not Specified	1%

Where there is need to clarify requirements; the relevant Australian and International Electrotechnical Commission (IEC) Standards are used to confirm compliance of our network for PQ. EQL also has the Standard for Network Performance, which provides key reference values for the PQ parameters.

The Network Performance Standard, Harmonic Allocation Guideline and the Standard for Transmission and Distribution Planning are joint working documents with Ergon Energy that describes the planning requirements including power quality. These guidelines apply to all supply and distribution planning activities associated with the network.

10.4 Power Quality Performance 2021-22

10.4.1 Power Quality Performance Monitoring

Processes for Power Quality (PQ) monitoring have been developed from the requirements of the Queensland Electricity Regulations and the NER Rules.

The introduction of a distribution transformer monitoring program in 2011-12 has provided a substantial source of data for analysis. Energex currently has in excess of 24,000 PQ monitors on distribution transformers throughout the network that monitor and record the network PQ performance. This program involves the installation of remotely monitored electronic metering on distribution transformers installed throughout Energex's network and is providing an insight into power quality performance at the junction between the 11kV and LV network.

Each of the PQ monitors contributes to give an indication of the state of the network for PQ parameters. The monitor data is downloaded daily, recorded, accessed and presented based on 10 minute averages. PQ reports are presented in various ways to identify potential network issues that may need urgent investigation and resolutions. The majority of PQ monitors are installed on the terminals of the distribution transformers with a quantity installed at the end of long the LV feeders due to difference in

load during the evening and rise in voltage during the day depending on the amount of solar along the feeder.

10.4.2 Steady State Voltage Regulation - Overvoltage

The number of monitored sites that reported overvoltage outside of regulatory limits of 253V was 1.4% for 2021-22. This means 1.4% of the monitored sites recorded an exceedance of the upper limit for more than 1% of the time based on 10 minute averages. This is slight improvement from the 2020-21 year. The change to the 230V standard is primary reason for the reduction. Figure 23 shows the number of monitored sites that have recorded over-voltage conditions for the last 5 years and percentage of overvoltage sites for each year. This is the fifth consecutive year that improvement has occurred to reduce the number of sites with overvoltage issues.

The take-up of solar PV is substantially greater in South East Queensland than in Southern states and regional Queensland and as a result the requirement to monitor power quality is commensurately greater.

Most PQ monitor sites are at the terminals of the distribution transformers however Energex also have a number of monitors at the end of long LV runs. Sites that only have a monitor at the transformer terminals may find the voltage not within limits at the further end of the LV network under load conditions. Improvements will continue to be achieved by implementation of the Customer Quality of Supply strategy.

Figure 23 – Number of Monitored Sites Reporting Overvoltage

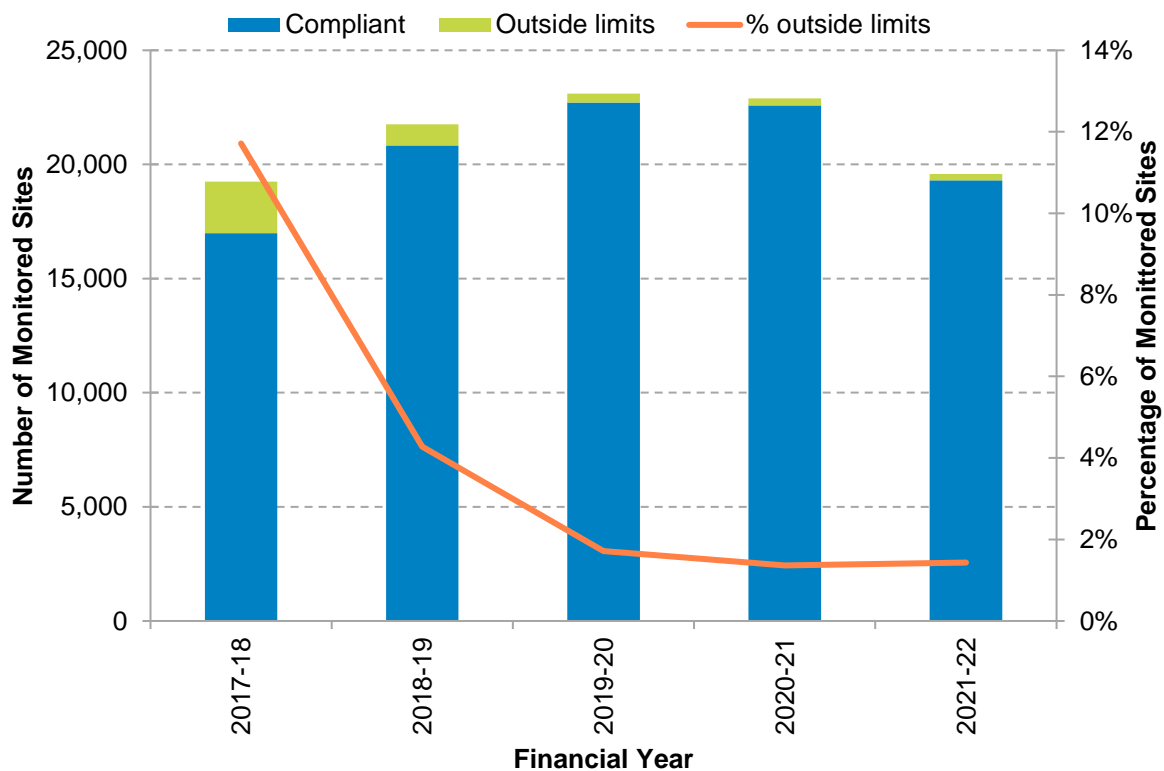

10.4.3 Steady State Voltage Regulation – Under Voltage

The change to 230V sees the lower limit for Low Voltage move to 216.2V. The number of monitored sites that recorded under voltage outside of regulatory limits of 216.2V was 0.7% for 2021-22. This means 0.70% of monitored sites recorded an exceedance of the lower limit for more than 1% of the time based on 10 minute averages. Figure 24 shows the number of monitored sites that have recorded under-voltage conditions for the last 5 years. There has been a slight increase from the 2020-21 year.

Figure 24 – Number of Monitored Sites Reporting Under Voltage

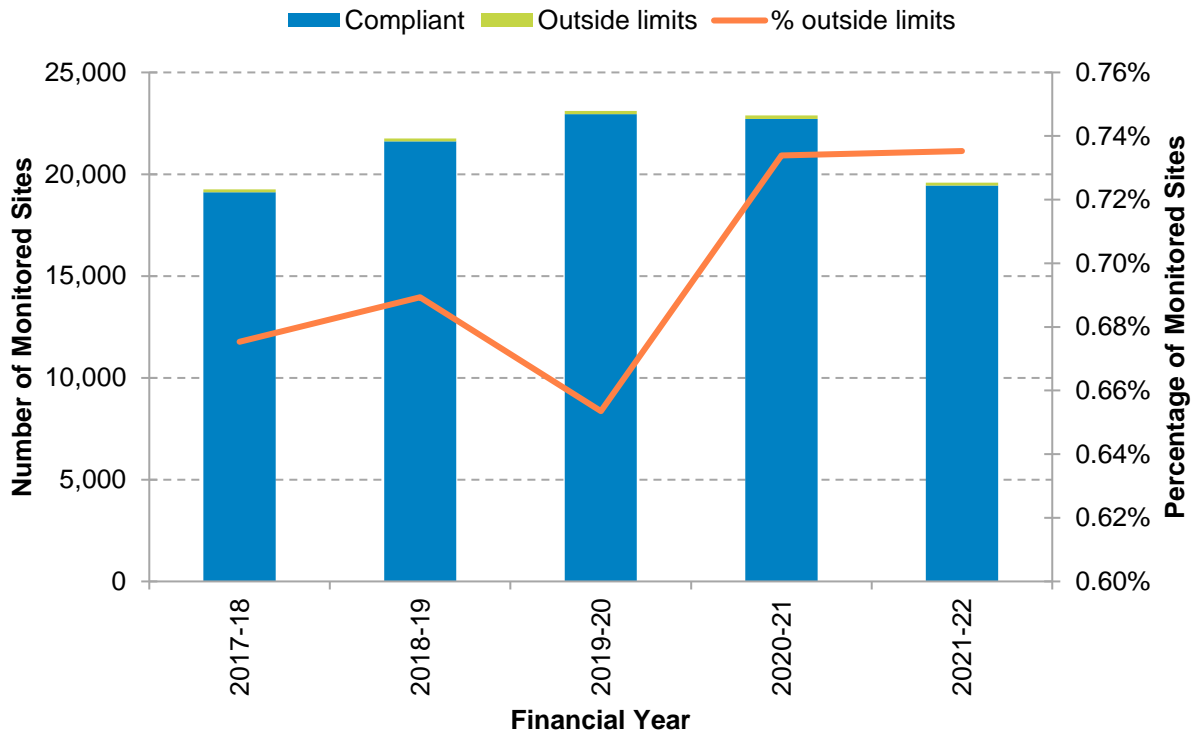

10.4.4 Voltage Unbalance

Data from the 3-phases shows that 0.89% of these sites were outside of the required unbalance standard of 2.5% during 2021-22. Figure 25 shows the number of sites that have recorded unbalanced conditions for the past five years.

The unbalance is mainly due to the increase in solar systems along the LV networks. Since the solar systems are not at every premise, just irregularly along the LV, some LV distribution networks become unbalanced as reported by the monitors.

Figure 25 – Number of Monitored Sites Reporting Voltage Unbalance

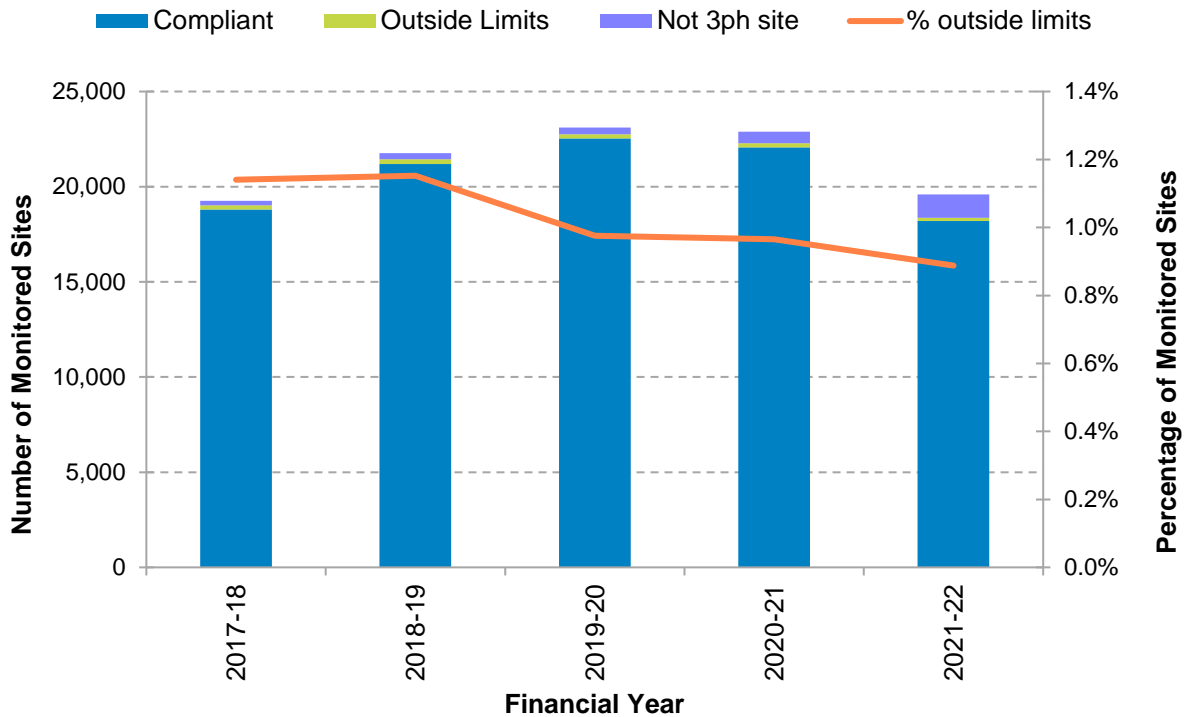

10.4.5 Harmonic Distortion

Total harmonic distortion (THD) is a measure of the impurity of the supply voltage and is primarily due to customer loads. Data from monitored distribution transformers was analysed for THD and this is displayed in Figure 26 for the 5 past years. The graph shows that 0.53% of monitored sites had THD that exceeded the 8% threshold stipulated in Australian Standards. This is a marginal decrease from the 2021-21 recorded value. Typical sources of harmonic distortion include electronic equipment incorporating switch mode power supplies, modern air-conditioners with variable speed drive inverters and solar PV inverters. The data indicates that customer equipment is largely conforming to the Australian Standards for harmonics emissions, but continual vigilance is required to ensure harmonic levels remain within the required limits.

Figure 26 – Number of Monitored Sites Reporting Total Harmonic Distortion

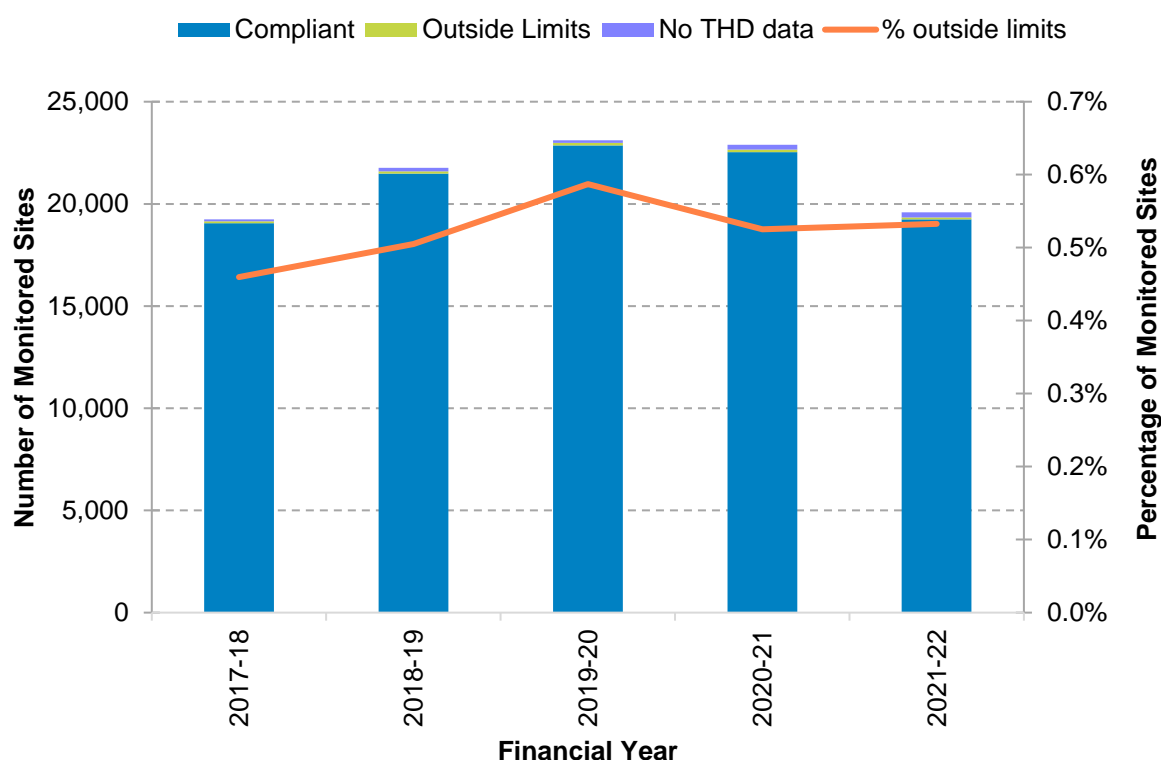

10.5 Power Quality Ongoing Challenges and Corrective Actions

During 2021-22 Energex voltage management strategy focussed on the impacts on Low Voltage (LV) customers. In 2019, Energy Queensland finalised the Customer Quality of Supply Strategy which covers the LV areas of the Power Quality strategy for Energex and Ergon Energy. It covers the changing network connections and configurations, increasing customer peak demands, the high penetration of solar PV and its continued growth, the Battery Energy Storage Systems (BESS) and the impact of Electric Vehicles (EVs).

10.5.1 Low Voltage Networks

The high penetration of solar PV systems on the LV networks has highlighted some of the limitations in the network. The main issues have been in balancing the solar PV systems during the day and peak loads during non-daylight periods on the LV network. This continues to require on-going work to ensure the PQ parameters are maintained within limits and to ensure neutral currents are limited. The Customer Quality of Supply Strategy for 2020-25 has identified the need for further monitoring of the LV network.

The continued increase of solar PV shows that continual vigilance and expenditure will be required throughout the network to ensure it remains compliant with the relevant PQ standards. The full impact of solar PV is discussed in Emerging Network Challenges and Opportunities Chapter 11.

As part of its OPEX program, Energex will carry out targeted transformer tap adjustment programs and rebalancing programs to address voltage issues in areas with solar PV penetration exceeding 30%. This

is supported by data showing significant numbers of distribution transformer tap settings on non-optimal settings and unbalance of voltages at distribution transformer LV terminals.

10.5.2 Planned actions for 2020-25 Regulatory Period

Energex will continue to have a focus on voltage management for low and medium voltage network issues identified through PQ data analysis. This will be further supported by determining suitable methods to monitor and rectify the network to ensure compliance continues. Typical rectification of voltage and PQ issues could include the installation of Statcoms, and Low Voltage Regulator (LVR). In addition, Energex is currently trialling technology of On Load Tap Changers (OLTC) on a few of its distribution transformers.

Chapter 11

Network Challenges and Opportunities

- Solar PV
- Strategic Response
- Electric Vehicles
- Battery Energy Storage Systems
- Land and Easement Acquisition
- Impact of Climate Change on the Network
- Minimum System Load – Emergency Backstop Mechanism

11 Network Challenges and Opportunities

Energex faces a number of specific network challenges and opportunities as it seeks to balance customer service and cost. These include the continuing network impacts related to the growing penetrations of solar PV, battery energy storage systems and electric vehicles, climate change, and land and easement acquisition.

11.1 Solar PV

11.1.1 Solar PV Issues and Statistics

In Energex's network, 45% of detached houses have a solar PV system connected, with an average inverter capacity of around 4.8kVA. The rapid uptake of solar PV has changed the way power travels through the network, from a purely one-way to bi-directional energy flow. The impact is greatest in the LV network and creates several system design and operational challenges. Due to the PV penetration level on its network, Energex is on the leading edge of the Australian distribution industry in responding to these issues. It is deploying a range of projects and initiatives to ensure safe operation of the network, a secure and high-quality supply, and economically viable solutions for customers both with and without solar PV.

The monthly volumes of solar PV connections trended downwards over 2021-22. Each month on average, around 3,100 new systems with a combined capacity of around 31MVA, and average inverter capacity of 9.9kVA, were connected on residential and business premises. In the previous year, around 4,200 new systems were connected each month on average, at an average capacity of 8.8kVA. Energex now has a total of 527,934 PV systems connected (at June 2022) with an installed inverter capacity of 2,885MVA, with around 97% of systems installed on residential rooftops.

Figure 27 shows the increase in installed solar PV inverter capacity, including small and medium scale PV systems. Over the past 12 months, the volume of connections decreased by around 26%, and the PV capacity decreased by around 16%. The 369MVA of PV capacity added did not include any solar farms. The ongoing growth in the number of small- and medium-scale PV systems is increasing the number of distribution transformers with high solar PV penetration, and over the year, over 40% of zone substations experienced reverse power flows during the middle of at least one day.

Figure 27 – Grid Connected solar PV System Capacity by Tariff as at June 2022

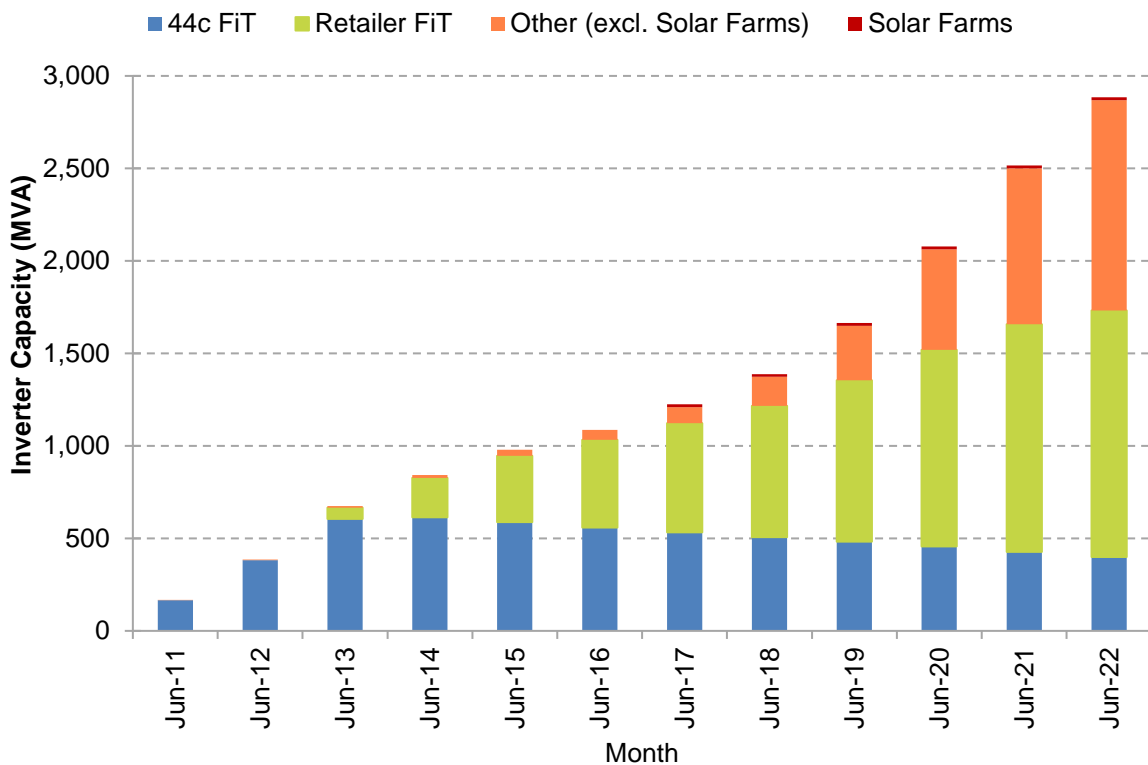

Another significant network issue resulting from increased solar PV connections is voltage rise and unbalance on LV networks. Voltage typically rises notably when solar PV generation and export is high. Energex had approximately 425 Quality of Supply enquiries in 2021-22 related to solar PV, predominantly resulting from high voltages. This volume represented a 20% reduction from the previous year. This result reinforces the value of initiatives we have undertaken, or are undertaking, to minimise the impact of increasing volumes of solar PV on the network and reduce the cost to resolve constraints, including the transition to a 230V network standard, tariff review, trialling new technologies such as LV Statcom, and energy storage trials. We have also worked with a diverse group of industry partners through the Solar Enablement Initiative and Expanded Network Visibility Initiative with the aim of applying advanced modelling and data analysis to enhance our visibility of network power flows to support the hosting of additional solar PV capacity. Implementing a 230V network standard is allowing more voltage variation, allowing many existing solar PV systems to operate more effectively and allowing more customers to connect solar PV systems and export to the grid.

11.1.2 Impacts of Solar PV on Load Profiles

Solar PV is impacting load profiles, asset utilisation, load forecasting and load volatility. Before solar PV systems reached a critical mass, the total aggregated demand on our network peaked between mid-afternoon and early evening during summer, generally on the hottest days of the year. The impact of solar on the shape of our network load profile is evident in peak load statistics. The system demand peak is now recorded in the evening, so the timing of the peak is not directly affected by PV generation, as PV systems are not generating at this time.

Figure 28 shows the daily load profile of North Maclean zone substation (located south of Brisbane) for ten consecutive years in the shoulder season as the penetration of solar PV systems on this substation has grown. The trend of reducing minimum demand on the feeder during daylight hours is apparent.

Figure 28 – Spring Load Profile with increasing Solar PV of North Maclean Zone Substation

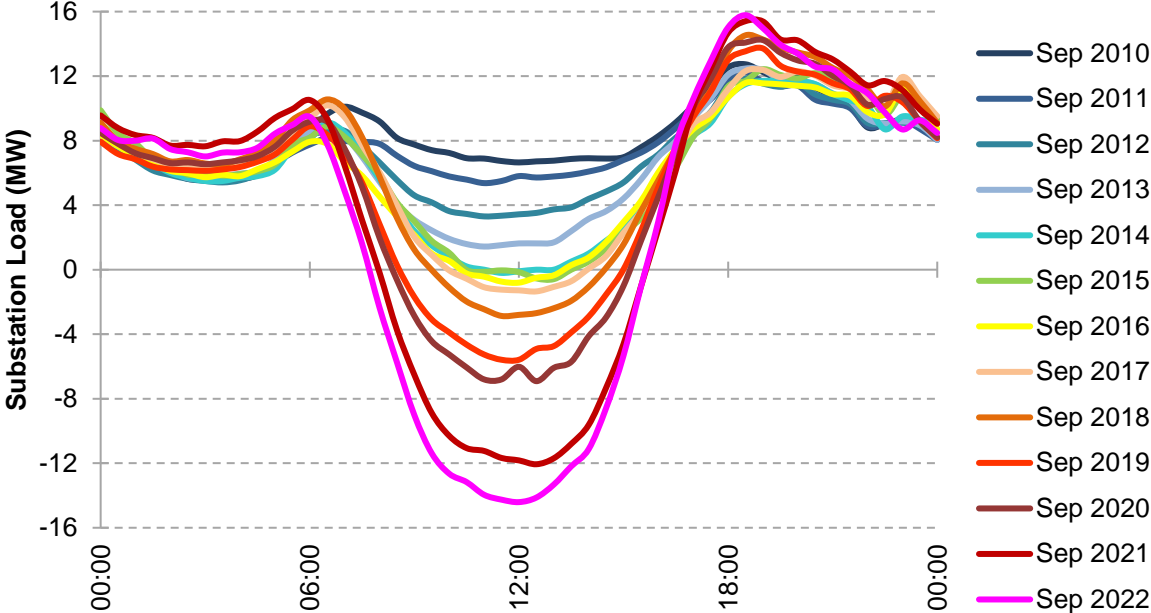

The increase in Embedded Generation (EG) on our feeders makes it more challenging to identify underlying load growth, as additional daytime load can be offset by local generation. Variation to electricity use patterns or growth in load only becomes fully apparent when an unexpected event causes the solar PV systems to stop generating.

On occasions where solar PV generation is not available, such as during an afternoon thunderstorm, the full customer load must be supplied from the network, which can result in large and rapid variations in energy flows.

In such instances, the demand on the feeder is extremely volatile; low during the day with consumers generating and also consuming energy, then rapidly peaking when the storm clouds roll in. The solar PV generation can fall away completely for a short time yet the customer load reduction can be delayed as air conditioners continue to run. The net result is a peak demand event in the early afternoon that can be higher than the feeder’s usual evening peak.

As networks are designed for supplying the maximum demand required by our customers, increasing penetrations of intermittent embedded generating units will significantly increase the complexity of planning and operating networks, and could result in excessive voltage drops, overloading of components, protection operation issues and loss of supply if not appropriately managed.

Figure 29 and Figure 30 shows the uptake of solar PV across the Energex network based on zone substation supply areas. Figure 30 indicates the total installed capacity in each zone who have solar PV installed and Figure 29 indicates the proportion of customers with solar PV in the same areas. The zone substation areas with the highest numbers have been highlighted on each map. Figure 31 displays the percentage of solar PV penetration by zone substations.

Figure 29 – Number of customers with Solar PV by Zone Substation

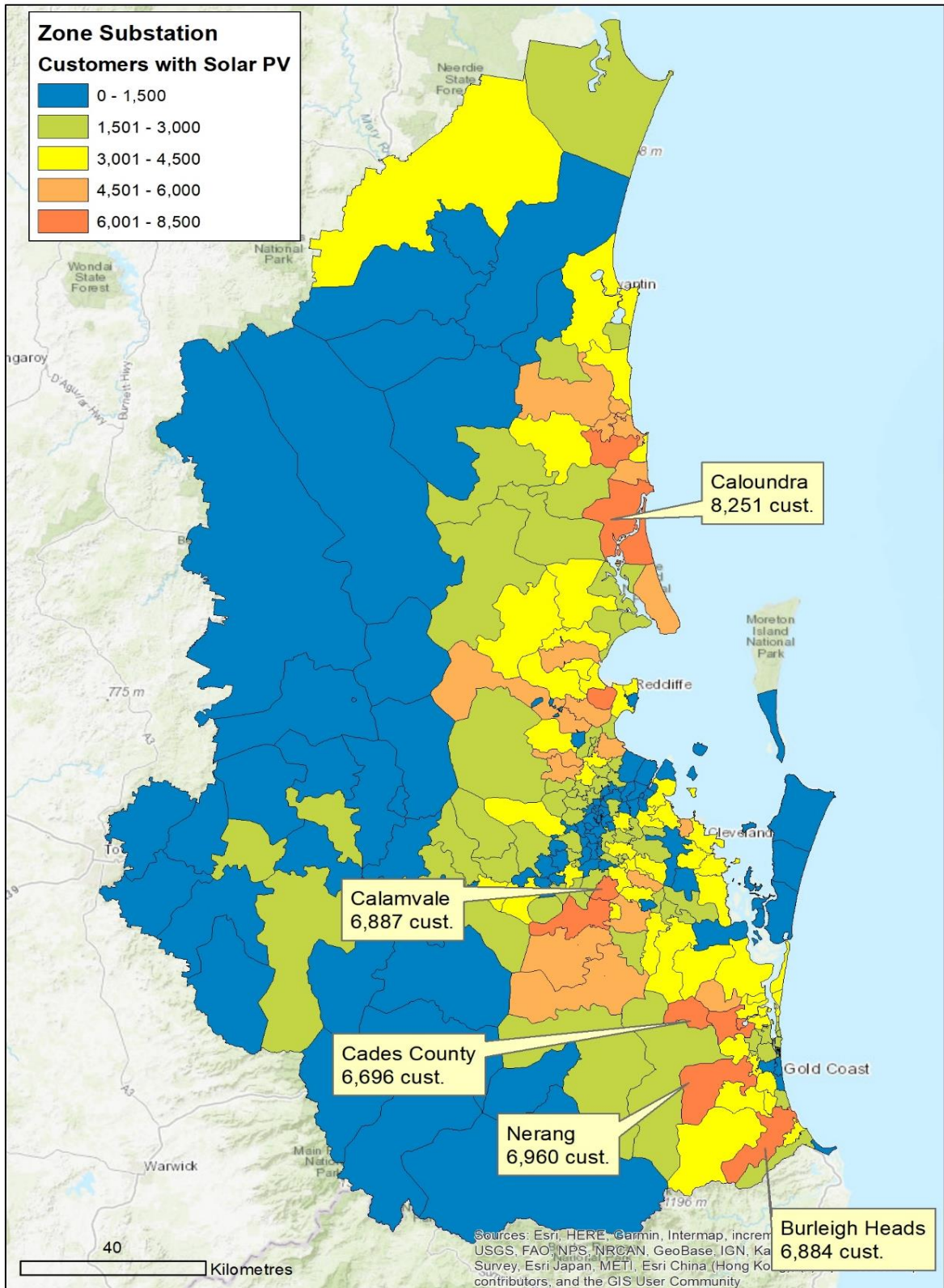

Figure 30 – Installed Capacity of Solar PV by Zone Substation

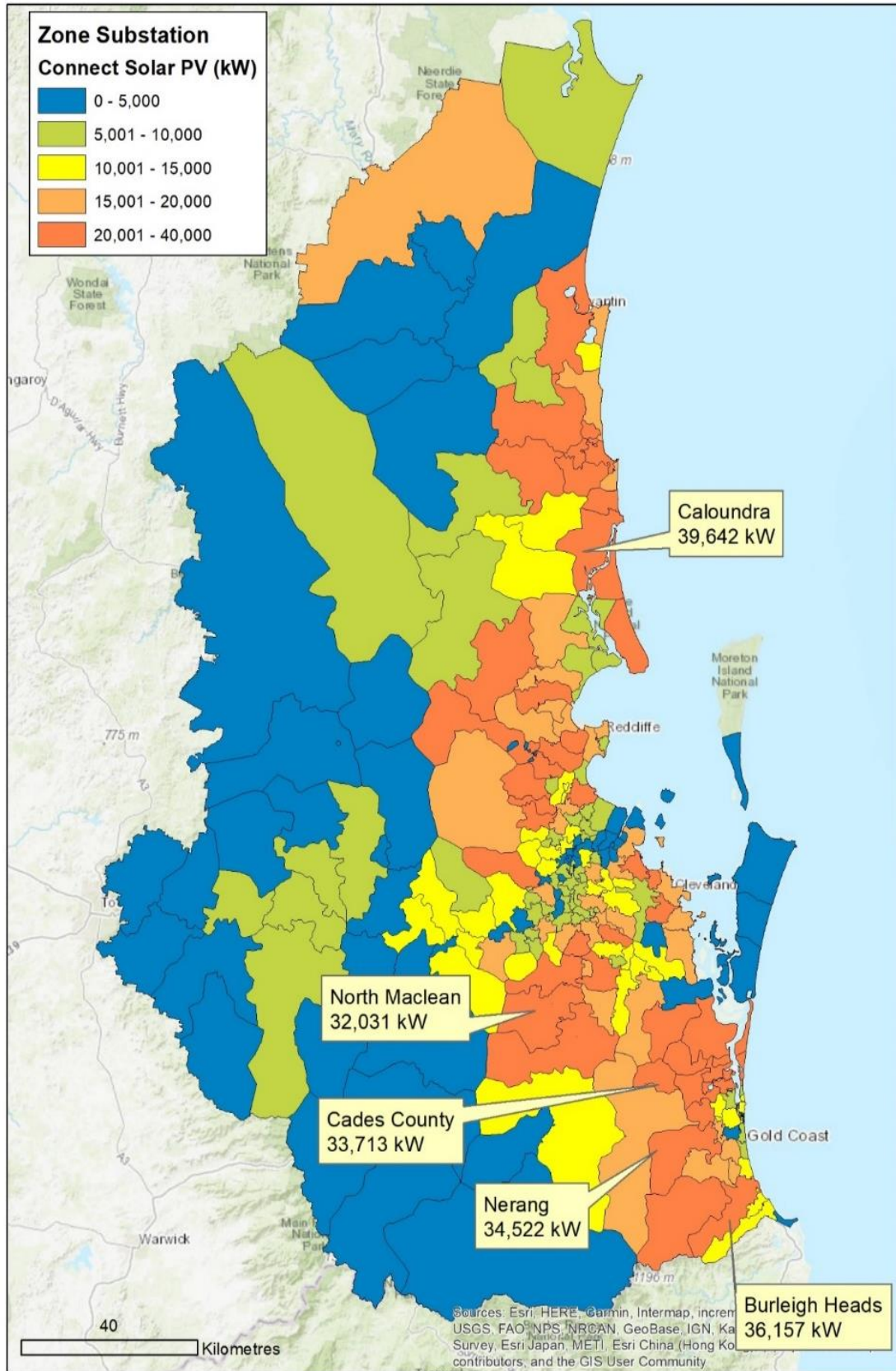
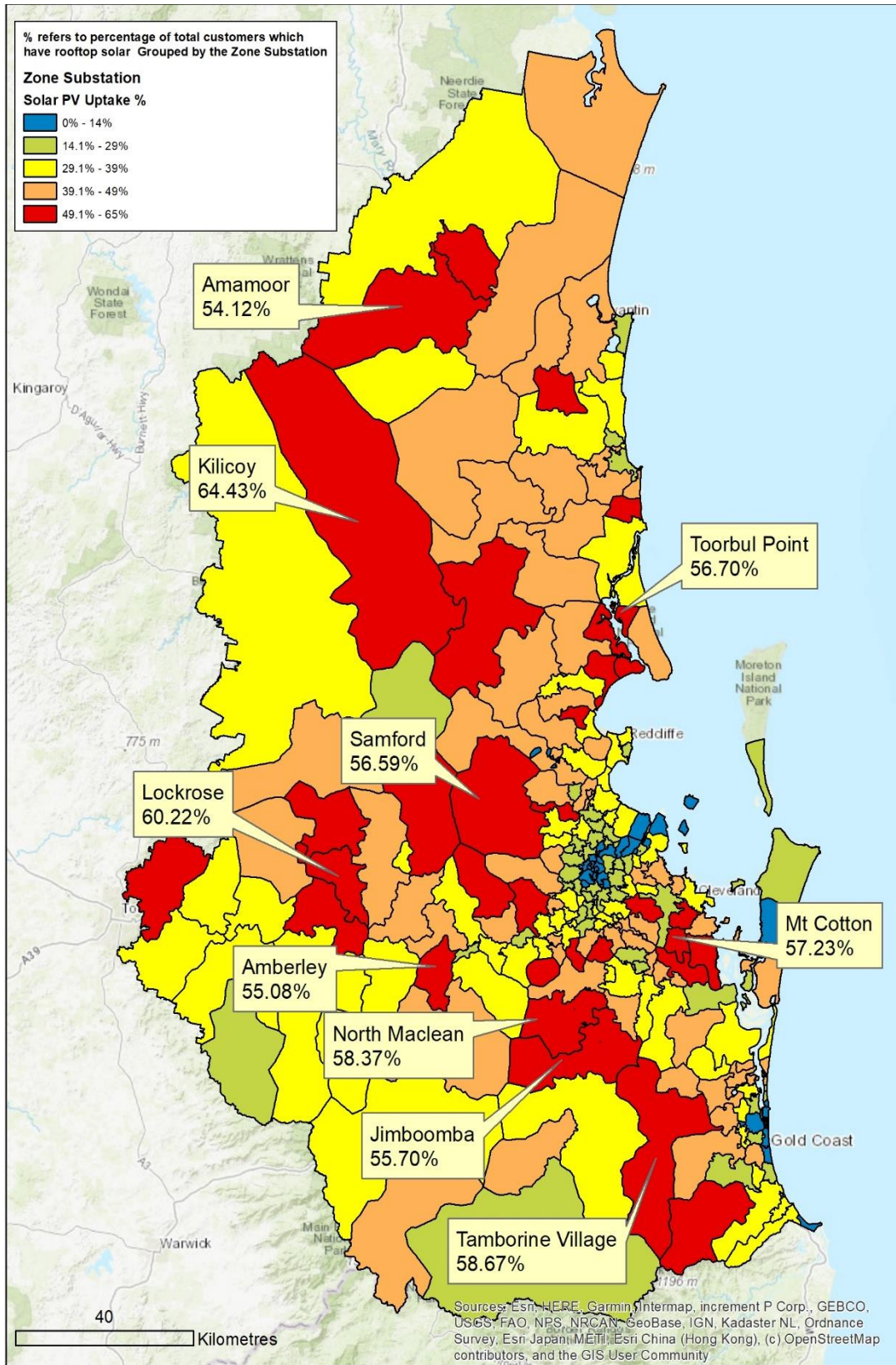

Figure 31 – Percentage of Solar PV Penetration by Zone Substation



% refers to percentage of total customers which have rooftop solar Grouped by the Zone Substation

11.1.3 Solar PV remediation options

A range of traditional, new technology and non-network solutions as shown in Table 29 are used to address network limitations associated with increasing PV penetrations at the LV, MV and zone substation levels. The most cost-effective solution and the PV penetration at which it is required will be site specific and overtime several solutions may be implemented to maximise PV hosting capacity.

Table 29 – Remediation options for increasing penetrations of solar PV

	Network Solutions	Non-network solutions
	1. Change transformer tap	I. Update zone substation AFLC schedules
	2. Phase balance PV & load	Coordinated via LV DERMS
	3. Upgrade distribution transformer capacity	
	4. Install additional distribution transformer &. reconfigure LV area	II. Implement Dynamic Operating Envelopes on new DER
	5. Re-conductor LV mains	III. Procure non-network load/generation shifting service from the market
	6. MV upgrade where multiple LV networks impacted	
	7. New technology (LV Regulator, Statcoms, Voltage Regulating Distribution Transformer)	

11.2 Strategic Response

11.2.1 Roadmap to an Intelligent Grid

While there are a number of scenarios that could eventuate beyond 2025, it is certain that the immediate period (to 2025) and ultimately at least the next two decades will see significantly higher levels of intermittent and controllable DER, new and increasingly active energy service providers, and an increased emphasis on the role of distribution networks on the overall system and market operation. Drawing from work such as the Energy Networks Australia and [CSIRO Electricity Network Transformation Roadmap](#) (ENTR)⁴¹, and looking globally at other progressive markets – such as the UK, Germany, California, New York, and New Zealand – it is apparent that the network business model will need to further evolve to become the operator of an intelligent grid platform.

In response Energex has developed a [Future Grid Roadmap](#)⁴² to provide a guiding, holistic pathway for transforming the network business to have the capability necessary to achieve the following:

- Support affordability whilst maintaining security and reliability of the energy system
- Ensure optimal customer outcomes and value across short, medium and long-term horizons – both for those with and without their own DER
- Support customer choice through the provision of technology neutrality and reducing barriers to access the distribution network

⁴¹ Website: <https://www.energynetworks.com.au/projects/electricity-network-transformation-roadmap/>

⁴² Website: <https://www.talkingenergy.com.au/40930/documents/98191>

- Ensure the adaptability of the distribution system to new technologies
- Promoting information transparency and price signals that enable efficient investment and operational decisions.

As an immediate priority, the roadmap also outlines the no-regret investments necessary to ensure efficient management and operation of the distribution network during the immediate period, while allowing a smooth transition to the future network business role.

11.3 Electric Vehicles

The charging of Plug-in Hybrid Electric Vehicles (PHEVs) and Battery Electric Vehicles (BEVs), together termed EVs, create a new class of electrical load that could have significant impacts on the Low Voltage (LV) electricity network and upstream aspects of the electricity supply chain. EVs are already popular overseas, so while still forming an emerging industry in Australia, their numbers are expected to grow dramatically in Queensland as their purchase costs decrease, availability increases, and more charging infrastructure is deployed.

The likely growth in EV numbers also presents us opportunities to collaborate with relevant stakeholders to create customer access to optimal private and public charging solutions based on the affordability and convenience priorities of both private and commercial EV owners. If EV owners increasingly charge their vehicles outside network peak demand periods, this will enhance network utilisation, reduce customer charging costs and deliver many other significant benefits to our business and other stakeholders. As the proportion of electricity entering the grid from renewable energy sources, and the uptake of solar PV systems, increase, the greenhouse gas emissions intensity of electricity generation and distribution reduces, creating an increasing environmental advantage for EVs over petrol- or diesel-fuelled vehicles

In the 12 months to 30 June 2022, the volume of EVs registered in Queensland increased by 86% to more than 11,700 vehicles. More than 90% of those EVs are in South East Queensland. Although passenger EVs only account for 0.4% of all registered cars in Queensland, 3.5% of cars sold over the previous 12 months were EVs, up from 1.6% in the previous year. There is no evidence that EV charging is having any detrimental impact on the network to date. As EV volumes inevitably increase, and potentially rapidly, network challenges will emerge; however, so will opportunities to manage EV charging to deliver benefits to the network, the entire electricity supply chain, EV owners and all electricity users.

Energex aims to play its part in enabling EV ownership and better understand and capitalise on EV charging. To help achieve this, we have developed a Network Electric Vehicles Tactical Plan, which is available on our [website](#)⁴³.

The tactical plan outlines the key actions our network business is taking to prepare for EVs. Three tactics are now defined as complete. In the next version of the tactical plan to be released in late 2022, completed tactics will be replaced with new tactics, and other tactics updated and reiterated.

⁴³ Website: <https://www.energex.com.au/manage-your-energy/smarter-energy/electric-vehicles-ev/our-ev-plan>

11.4 Battery Energy Storage Systems

The adoption rate of Battery Energy Storage Systems (BESS) is still modest, with only around 2% of solar PV owners on our network having invested in a BESS. However, our 2022 Queensland Household Energy Survey results indicate that 15% of south-east Queensland respondents who have heard of battery storage intend to install a system within the next three years.

Energex continues to monitor influencing factors and technologies in the residential and commercial BESS market to evolve our relevant standards, safety and connection requirements. We recognise the potential for BESS to provide network benefits (addressing peak demand and/or power quality issues) and customer benefits; however, we also recognise the barriers to effectively utilising this developing resource.

The number of BESS installations connected to the Energex network was around 6,800 BESS in June 2022. The average capacity of a home BESS is around 10kWh. Experience from the testing of BESS available on the market suggests that there is opportunity for increased sophistication in the systems operation that would increase the potential value that the systems provide to the network and customer. Improved market signals would be required to stimulate these improvements.

Under our Local Network Battery Plan, we are trialling the deployment of both pole- and ground-mounted BESS onto selected Low Voltage (LV) networks, primarily to absorb PV generation exported to the grid then discharge that electricity during peak demand periods to help meet demand without needing to upgrade those networks.

11.5 Land and Easement Acquisition Timeframes

One of the key difficulties for large community infrastructure projects is the ability to locate infrastructure over large distances and across several communities. Without the land and property acquired in advance, there can be no design, construction or connection of new electricity infrastructure or non-network solutions to meet the increasing electricity demands within a region.

Community expectations have risen over the years by increased calls for input and participation into these projects, which Energex must now consider for future works, while ensuring that statutory requirements are met regarding social, technical and environmental disciplines, all with the intent of providing a value for money outcome for all.

Corridor easement acquisition projects often span more than one regulatory period and there is increasing evidence that further upfront community engagement, planning and investigation will improve the ability of Energex to construct these corridors in a more timely fashion, once community and key stakeholders have predominantly endorsed the specific route determined for the new lines.

A key risk with this requirement involves the availability of obtaining key design resources and personnel so far in advance of the actual project. In order to ensure that corridor projects are approved, there is a need for dedicated budget to address planning, community collaboration and education as well as investigation of various routes in order to ensure the corridor selected meets the requirement of both statutory, key stakeholder and community expectations. These objectives must be met whilst also meeting Energex's obligation to our customers to get an outcome that is value for money, while still meeting the key technical, environment and social requirements.

11.6 Impact of Climate Change on the Network

A changing climate is leading to changes in the frequency and intensity of extreme weather and climate events, including extreme temperatures, greater variations in wet and dry weather patterns (e.g. flooding, drought), bushfires, tropical cyclones, storms and storm surges, as well as changing sea levels. These events increase the likelihood of inundation or other damage to exposed and low-lying Energex assets, creating reliability problems as well as associated maintenance and asset replacement expenditures.

Energex, as part of EQL, acknowledges and aligns with the Queensland State Government Pathways to a climate resilient Queensland, Queensland Climate Adaption Strategy 2017-2030 and has a Low Carbon Future Statement and an Environmental Sustainability and Cultural Heritage Policy.

Energex proposes to mitigate the impacts of climate change on our network by:

- Keeping abreast of changes in planning guidelines and construction standards
- Keeping abreast of new storm surge and flood layers produced by councils and other agencies
- Undertaking surveillance and flood planning studies on network assets which are likely to be impacted by significant weather events, storm surges and flooding
- Undertaking network adaptations that mitigate the risk of bushfire
- Assessing the ability of our network to withstand increasing weather events and the impact on customer reliability.

11.7 Minimum System Load – Emergency Backstop Mechanism

The overall demand for electricity from the grid is falling, particularly in the middle of the day when large amounts of electricity is being generated from solar systems and exported back into the electricity grid. This is creating a challenge referred to as ‘minimum system load’. The grid can handle large amounts of solar and there are a range of actions that network operators implement to ensure our system stays safe and secure. As Queensland is connected to the national electricity grid, changes in the balance between supply and demand can be managed across the network by the Australian Energy Market Operator (AEMO), Powerlink Queensland, Energex and Ergon Energy Network. However, modelling by AEMO has found that if the connection between Queensland and the national electricity grid is interrupted when there are very low levels of demand and high levels of solar output, there is a risk that some parts of the electricity network in Queensland could experience blackouts. To reduce this risk, and allow more solar to be safely connected to the network, a new emergency measure has been established that can be used as a last resort, after all other actions have been taken, to keep our power supply secure. This emergency measure is referred to as the ‘emergency backstop mechanism’.

From 6 February 2023, all new and some replacement inverter energy systems (like rooftop solar PV), with aggregated capacity of 10kVA and above, will need to have a Generation Signalling Device (GSD) fitted that will enable the inverter to receive a signal to switch off. The signal is sent to the GSD from Ergon Energy Network and Energex’s powerline signalling system, known as Audio Frequency Load Control (AFLC). For larger sites with multiple inverters, including embedded networks, installers have the option of using a GSD on each inverter or installing a single GSD connected to a Demand Response Controller. Some exclusions apply to the requirement to install a GSD – including inverter energy systems where the inverter is solely supplied by a battery, and any inverter energy systems installed at a location that is not serviced by the AFLC system.

The emergency backstop mechanism will be instigated by Ergon Energy Network and Energex under the direction of AEMO in alignment with the Distribution Authorities set out by the Department of Energy and Public Works, to help maintain a safe and secure network. This will only occur in response to specific network emergency conditions, such as when the main electricity connection between Queensland and the National Electricity Market (NEM) is offline at the same time there are high levels of PV generation being exported back into the grid. It cannot be operated under any other circumstances, and it will only be instigated after various other mechanisms available to the network operators have been implemented. Further information can be obtained from [Emergency backstop mechanism](#)⁴⁴.

⁴⁴ Website: <https://www.energex.com.au/our-services/connections/residential-and-commercial-connections/solar-connections-and-other-technologies/emergency-backstop-mechanism>

Chapter 12

Information Technology and Communication Systems

- Information Communication and Technology
- Forward ICT Program
- Metering
- Operational and Future Technology

12 Information Technology and Communication Systems

12.1 Information Communication and Technology

12.1.1 Information Communication and Technology Investments 2021-22

This section summarises the material investments Energex has made in the 2021-22 financial year, relating to Information & Communications Technology (ICT) systems.

Energy Queensland recognises ICT as a key enabler of efficient business operation, customer services and safety management and aligns its digital strategy to provide technology solutions which are secure, sustainable, and affordable. This is being achieved by prioritising the consolidation of digital solutions for both Energex and Ergon Energy. The key focus for the year was delivery of scope consistent with the AER Plan approved for the five-year period that began on 01 July 2020. The key focus areas for this year have been:

- Enterprise Asset Management solution transformation
- Upgrade of the Network's Distribution and Outage Management systems,
- Asset Inspection and Monitoring Tools replacement,
- Planning for the replacement of the Customer and Market Systems suite of solutions, and
- Protecting the security of the digital network through improving Cyber Security maturity.

In addition to the core delivery program, a number of operational investments commenced or completed to ensure the ongoing stability of Energy Queensland's suite of digital capability and infrastructure.

Table 30 contains a summary of Energex's ICT investments undertaken in 2021-22. These include projects which commenced prior to this year and investments not completed by 30 June 2022. Further information on the scope of each initiative can be noted below.

Table 30 – ICT Investments 2021-22

Description	Cost \$ M actual
Asset and Works Management	\$33.70
Distribution Network Operations	\$5.56
Customer and Market Systems	\$4.91
Corporate Systems	\$31.52
ICT Management Systems, Productivity and Cybersecurity	\$3.90
Infrastructure Program	\$9.19
Minor Applications Change and Compliance	\$2.87
Total	\$91.73

Note: Actual costs represent investment of the ICT Managed Capex Program of Work for Energex only and does not include ICT investment funded through other portfolios already identified in other sections of this report.

Asset and Works Management

The Asset and Works Management (AWM) stream is considered one of Energy Queensland's Digital Enterprise Building Block (DEBBs) being delivered as part of an overarching program. Two key initiatives were progressed during 2021-22.

AWM is delivering integrated functionality to help Energex manage its asset investment portfolio and integrated Program of Work (PoW). This includes maintenance planning, scheduling, and delivery of all types of work in the field critical to the reliability and safety of the electricity network. The first release has provided the ability for EQL Fleet teams to own and manage their fleet data and refine information within the maintenance plans and strategies. The focus for 2021-22 has been further developing the solution for roll out across all areas and field crews.

The Geographic Information System (GIS) is a key element of the asset management process. Between the EAM and the GIS, the core data for each asset within the physical and electrical network models are mastered, while supporting the major asset lifecycle processes of design, build and commissioning. Energex's existing system is end of life, significantly customised and no longer adaptable to business change. The replacement of this solution with a sustainable, best practice solution occurred in 2021-22, resulting in productivity improvements and network capital efficiency.

Distribution Network Operations

The Network Operation Control systems provide the technology to better connect our people, technology and data to manage the distribution of electricity for customers. Planning that occurred in the previous period has been leveraged to deliver a consolidated, proven, and modernised platform with consistent business processes for Energy Queensland. This will allow teams to support each other seamlessly and maximise business continuity in times of significant events anywhere in Queensland. The upgrade of Energex solution and new capability for Control Centres was undertaken during 2021-22.

Customer and Market Systems

Customer and Market Systems include the digital applications, tools and data stores to support Energex's market compliance, customer and stakeholder management functions in areas including contact centre services, customer information management, meter data management and retailer invoices and remittance management and are critical systems in supporting Energex with fulfilling its market obligations. Existing systems are ageing, not keeping up with technology advances and cyber threats and in some cases no longer supported by vendors. Planning for the replacement of the suite of Customer and Market Systems completed during 2021-22 resulting in approval to commence the implementation phase.

Corporate Systems

Energex's core Enterprise Resource Planning (ERP) system reached both technical and financial obsolescence in mid-2015. Renewal of the ERP systems with contemporary systems commenced late in the previous regulatory period and is being finalised in the current period.

The People, Culture and Safety program has implemented a modern technology platform to replace people process related IT system including core human resource function in addition to recruitment, training, and talent management solutions.

The Procurement stream has established a new platform to enable consistent effective procurement processes and strategic contract management.

Energex's document and records management system is being replaced by leveraging the foundation capability delivered by the new ERP system. This is building a contemporary, consolidated solution for Energy Queensland and is delivering improved shared services productivity through best practice processes and ensures ongoing compliance with regulatory and legislative requirements as specified in the Public Records Act.

ICT Management Systems, Productivity and Cybersecurity

Energy Queensland operates in one of the most-commonly targeted sectors for cyber-attacks. As these threats continue to evolve, reaching into industrial control systems and supply chains, it requires even greater efforts to manage risk. EQL has some specific cyber risk factors relating to the convergence of Information Technology and Operations Technology, and the strategic importance of Critical Infrastructure. During FY21-22, a revised Cyber Security Strategy and a new Information Security Policy was developed, which focuses on getting our foundations right and building for the future beyond 2025. The Cyber Uplift Program (CUP) is ensuring EQL is safeguarding its information, and therefore it's customers against cyber security threats; maturing and strengthening our cyber security posture; developing a cyber security knowledgeable workforce; and building our cyber security maturity in line with industry good practice.

Infrastructure Program

The renewal of Energex's ICT infrastructure assets is delivered in accordance with Energy Queensland's ICT Infrastructure Asset Renewal Guidelines. Digital infrastructure and technology software asset performance degrades due to age and technical obsolescence. To sustain capability an ongoing program is required to replace these assets. Assets covered by the program include: Digital Fleet (desktops, laptops, mobile devices and video conferencing equipment), corporate data network equipment, server storage infrastructure renewal and growth. The program also includes infrastructure software renewal of ICT technologies such as Exchange Email, integration technologies and database environments.

Energy Queensland's 2030 Digital strategy identified the need for a digital response to disruptions through disintermediation, distributed energy, digital technology, and public policy agendas. This mandates the ability to respond quickly to changes and readiness to engage with emerging technology while maintaining safety, supporting positive customer experiences, providing excellent value for money to the Queensland community and protecting EQL data and systems while managing risk. A critical enabler for 2030 ambition has been the transition from a predominantly on premise ICT infrastructure to robust, secure, well managed, flexible, and efficient hybrid cloud infrastructure. An initiative was undertaken during 2021-22 to establish Cloud Broker capability

Minor Applications Change and Compliance

Investments to address safety and compliance during 2021-22 included changes to the Customer and Market Systems to ensure compliance to regulatory imposed settlement rule changes and annual tariff reform changes.

12.2 Forward ICT Program

As Energex looks toward the future, it will continue to ensure digital systems and capabilities are maintained for sustainability, cybersecurity, compliance, and operational safety. Continuing the inflight technology replacements and planning for additional improvement will also be leveraged to enable the company's planned productivity improvement.

Energy Queensland continues to be committed to the transformation program currently inflight, which is planned to be delivered across multiple years due to the scale and complexity involved in replacing several major systems in parallel. This approach has been agreed to realise efficiencies by reducing multiple integration activities that would have otherwise been required.

Ramping up of the Cybersecurity Uplift program and the Customer Market Systems Replacement program represent the key additions to the ICT Program from 2022-23.

A high level summary of potential Energex's ICT investment for the Distribution Business for the forward ICT Program is shown in Table 31. Emerging priorities and new technologies will result in ongoing prioritisation and may require adjustments dependent on the determination received. Forecasts have been grouped by initiative names as included in the ICT Plan for 2020-25.

Table 31 – ICT Investment 2022-23 to 2026-27

Initiative Name	2022-23 \$M	2023-24 \$M	2024-25 \$M	2025-26 \$M	2026-27 \$M
Asset and Works Management	51.84	17.75	6.75	8.50	3.50
Distribution Network Operations	5.58	1.97	3.50	5.25	15.00
Customer and Market Systems	10.90	6.82	-	-	-
Corporate Systems	21.29	5.86	6.46	3.50	3.50
ICT Management Systems, Productivity and Cybersecurity	6.57	3.50	4.50	3.50	3.50
Infrastructure Program	7.51	9.91	12.15	6.00	-
Minor Applications Change	1.78	1.25	2.75	1.25	1.25
Grand Total	105.46	47.05	36.11	28.00	26.75

Note: Forecasts includes ICT Managed Capex investment for Energex Limited and does not include ICT investment funded through other portfolios already identified in other sections of this report. Forecasts are represented as \$ Nominal values. Forecasts beyond the current regulatory period are estimates and likely to change.

12.3 Metering

Energex is currently separating load control from metering, as it relates to network operation and network management. Energex's plans will require that third-party metering providers retain the Energex load control assets installed in customer switchboards to maintain Energex's considerable load control facilities.

Energex will seek to maximise the remaining value in existing meter stocks, by leveraging existing metering capabilities wherever possible. For example, the current suite of interval capable electronic meters may be reprogrammed to support market offerings such as Time-of-Use (ToU) tariffs or other similar time-based pricing structures.

Energex will also continue to operate a Meter Asset Management Plan (MAMP) in a prudent and efficient manner to enable enhanced benefits and cost savings to customers.

Energex will continue to develop and implement consistent work practices and supporting standards, such as the Queensland Electrical Connection Manual (QECM) and Queensland Electrical Metering Manual (QEMM), to ensure these align with the rollout of smart-ready meters in a contestable marketplace.

12.3.1 Revenue Metering Investments in 2021-2022

There were no revenue metering investments in 2021-22 due to Power of Choice legislation that prevents Energex from installing any new meters.

12.3.2 Revenue Metering Investments from 2022-23 to 2026-27

The future investment in revenue metering by Energex will be minimal and will mainly be focused on network devices.

12.4 Operational and Future Technology

Energex is responsible for optimising the reliability, security and utilisation performance of the regulated electricity assets to ensure that both regulatory and corporate performance outcomes are achieved in a manner that is safe to the workplace and the public. Traditional distribution networks are facing several challenges brought about by customer energy choices and the introduction of new technologies such as grid energy storage, private battery storage, solar PV, voltage regulation solutions and a multitude of specialised monitoring tools and devices. Energex recognises that these technologies play a key role in improving the utilisation, reliability, security and performance of our regulated electricity assets.

12.4.1 Telecommunications

Energex's telecommunication strategy comprises a range of directions for the company:

- Transition away from obsolete Telecommunications technologies and equipment
- Ensure Obsolete technologies remain viable while still in service
- Improve management of supporting infrastructure
- Enable Regulated growth and reduce cost of Regulated services by aligning opportunities with un-regulated growth
- Improve Monitoring the Telecommunications Environment
- Cross stream initiatives
- Improve asset management of Telecommunications environment
- Re-organise responsibilities between divisions / groups and department to embrace automation, adoption of new technologies and digital enablement.

Key project / programs supporting the strategic directions are detailed below:

- **Project Matrix.** This is the core Internet Protocol/Multi-Protocol Label Switching (IP/MPLS) communications network and OTE providing Ethernet/IP services to support current and future operational systems. This is a multi-stage project which is currently finalising stage 5 with stage 6 currently in the design phase
- **Replacement of obsolete equipment.** Energex's existing operational telecommunications network is extensive and covers the majority of bulk and zone substations. The network includes various aging technologies including the Plesiochronous Digital Hierarchy (PDH) technology, which is now 20+ years old with key items starting to show increasing in service failure rates and the equipment is no longer supported by the original vendors. The strategy is to eventually replace links over optical fibre with IP/MPLS technology being rolled out on Project Matrix, and PDH radio links with IP radio links. This will be a key focus for the next 5-10 years. In the meantime, the current systems must be supported whilst the new IP/MPLS network is being deployed; the following lists some of the specific initiatives:
 - Access Switch / router equipment replacement at substations - replacement of specific equipment types that are experiencing high levels of in service faults in the switch fleet

- Replace older microwave radios.
- Programs to replace obsolete comms site infrastructure, including battery chargers, batteries, chargers, solar systems etc
- P25 radio system implementation, all base station equipment commissioned and 95% of the vehicle fleet has been cut over as of 1/7/2022
- Replacement of obsolete copper cable links. Much of the existing copper pilot cable network is 30 to 40 years old and is reaching end of design life. The strategy is to replace with optical fibre cable where practical. However, this often requires the associated replacement of substation equipment such as feeder protection relays.

12.4.2 Operational Systems

Energex classifies Operational Technology (OT) as the systems, applications, and intelligent devices and their data that can directly or indirectly monitor, control or protect the power network. The current systems within the OT scope are detailed below.

Supervisory Control and Data Acquisition (SCADA)

Energex's strategic plan for control systems called for the remote terminal units (RTUs) at substations to be upgraded to a consistent software version over a 5-year period in this reporting period. The Distribution Management System (DMS) has received a refresh of hardware and an upgrade of selected software components.

Work to select a replacement RTU for the in house developed unit that will be common across Energy Queensland has been completed. Work is underway changing support systems to allow the new equipment to suitably integrate into the current environment. Work to enable standardised integration of substation battery systems and customer Distributed Energy Resources (DER), in a manner enabling Dynamic Operating Envelopes (DOE) has been progressing. As well as enabling the initial substation battery systems, this is an enabler for DERMS (see Intelligent Grid Enablement section below) with the first systems scheduled for commissioning in Q1 2022.

The need for greater integration of substation secondary systems, including protection, SCADA, and telecommunications facilities has continued. Energex continues to evolve the solutions to enable the following advanced features to be deployed into the network:

- Protection relay interfacing with SCADA via Ethernet-IP based communications
- Migration of auto-reclose functions from SACS to protection relay to enable additional operational modes to provide improved safety of live line workers.

Energex is continuing the migration to Ethernet-IP based communications for a range of substation secondary systems devices including protection, SCADA, and telecommunications facilities.

Other changes

Energex continued the deployment of the Operational Technology Environment (OTE) at operational Data Centres. The following work was undertaken:

- Finalising the implementation of a new phone system to replace existing operator consoles
- Continued with provisioning a common OT environment to allow the deployment of a common Distribution Management System (DMS) and operator consoles for Energex and Ergon Energy
- Continued replacement of various end of life components within the Data Centres, including the firewalls and other components.

Operational Security

Energex continued migration of their core firewalls to the common OT environment and commenced renewing other security systems, e.g. F5s. This is moving Energex and Ergon to a secure combined Operational Technologies environment. Additional threats were identified during the period and a range of mitigation activities is occurring.

Intelligent Grid Enablement

Energex is investing in the development of a smarter network for the future. The growth of Distributed Energy Resources (DER) in distribution networks, both at residential and commercial levels, requires Energex to consider new approaches for maximising DER hosting capacity.

In order to deliver sustainable outcomes for the network and choice for customers, Energex has begun delivery of the following major capabilities:

- SEP2 (IEEE 2030.5) Utility Server - Implementation of a suitable and common communication standard between the DNSP and DER/aggregators to communicate constraints and opportunities is a critical building block in enabling 'active' connections for all customers. This work is a result of our stakeholder consultation on dynamic connection agreements available at <https://www.talkingenergy.com.au/dynamiccder>⁴⁵. Go live and external access to this server is scheduled for the first half of the 2022-23.
- The Telemetry Hub is an internal collection of systems that integrate, store, process and visualise the diverse and increasing streams of telemetered data from the electrical network and provide this information in a common format for consumption by multiple end use cases. 2021-22 saw the successful delivery of an internal user portal and production event streaming platform in co-operation with our Digital division.
- Distribution System State Estimation (DSSE) - A process for estimating the most probable electrical state of a network without the need for measurement data at every point. DSSE provides complete network visibility at any point in time using available data and can dramatically reduce the capital and operation cost of deploying physical monitors to the network. The DSSE and corresponding integrations were productionalised in 21/22, delivering near real time and historic state estimation to demonstration feeders.
- Capacity Constraint Optimiser (CCO) - A constraint engine which determines the active network performance and limits, applies allocation rules and passes subsequent constraint envelopes via an orchestration system to deliver the best outcome. Used in combination with the DSSE,

⁴⁵ Website: <https://www.talkingenergy.com.au/dynamiccder>

the CCO delivered an optimised operating envelope to the trial sites and was formed the basis of the network winning the [2021 ENA Innovation Award](#)⁴⁶.

- Distributed Energy Resources Management System (DERMS) – Similar to the existing Distribution Management System (DMS), the DERMS platform is being developed as a dedicated head end system to interact with and manage all sizes of DER and existing Audio Frequency Load Control (AFLC) infrastructure. It is envisioned to run with a high degree of autonomy with manual intervention by exception. In 2021-22 both a Request For Information (RFI) and Request For Tender (RFT) procurement exercises were run to establish a suitable technology partner for the network, with contract award forecast for mid 2022-23.
- Network model sharing by Common Information Model (CIM) – The as-built/as-operated model or 'digital twin' of the electricity network forms a critical foundation to many digitally enabling initiatives and as such, Energex is investing in standardising it's availability to new and existing systems. A trial was run in 2021-22 with a demonstration feeder exported from GIS systems into the common format and successfully re-imported into downstream systems. Productionalisation is planned for 22/23 via a dedicated digital project.

LV Network Safety Monitoring Program

Safety by design is fundamental to Energex's network strategy, providing safe and reliable electricity residents and businesses across South-East Queensland and is at the core of Energex's corporate values. Neutral integrity failures on the Low Voltage (LV) network are a significant cause of customer safety incidents. Energex is committed to customer safety imperatives and considers that the detection of neutral integrity failures is critical to mitigating customer safety risks. Energex is investing in deploying a smart network monitoring device with neutral integrity monitoring capability which will be installed under a dedicated safety program on selected customer premises throughout Queensland. The scope provides for gathering of field data, through purpose-built sensors and/or through smart meters, derivation of information from the field data, and detection and raising of alerts for neutral integrity failures in the Energex network and/or in customer installations.

The program provides a foundation to enabling further investment by Energex over the 2020-2025 regulatory control period in equipment, systems and processes to detect neutral integrity failures through increased LV visibility. The data leveraged from this platform will feed into various applications including the LV Management System of the Intelligent Grid Enablement program. In 2020-21, Energex successfully proved the technology concept through a pilot program and prepared the program for full deployment.

⁴⁶ Website: <https://www.energynetworks.com.au/events/2021-energy-network-industry-awards>

12.4.3 Investments in 2021-22

Table 32 summarises the SCADA and Communications investments for 2021-22.

Table 32 – Operational Technology Investments 2021-22

Project	Direct Cost \$ M actual
Telecommunications Network	
Telecommunications equipment replacement	\$3.60
MPLS system implementation	\$0.29
Fibre Cable installation	\$1.38
P25 implementation	\$0.96
Operational Systems	
Operator console replacement	\$1.43
Common OTE	\$0.10
OT Security projects	\$0.30
SCADA and Automation Refurbishment / Replacement	\$0.59
LV Network Safety Monitoring Program	\$0.10
Intelligent Grid Enablement	\$0.79
Total	\$9.54

Note: All financials presented in this document are correct at the time of writing and represent the existing organisational accounting treatment, which may be subject to change. Forecasted data is subject to ongoing variation due to COVID 19 impacts. Energy Queensland is finalising the alignment of its Cost Allocation Methodology between Ergon and Energex, potentially impacting the treatment of some Capital and Operational Project costs.

12.4.4 Planned Investments for 2022-23 to 2026-27

Table 33 summarises Energex's OT and associated Telecommunication planned investments for 2022-23 to 2026-27.

Table 33 – Operational Technology Planned Investments 2022-23 to 2026-27

Project	Direct Cost (\$ M planned)
Telecommunications Network	
Telecommunications equipment replacement	\$23.24
MPLS system implementation	\$2.18
Fibre Cable installation	\$8.63
Comms Network Enhancements	\$7.90
Operational Systems	
OT Security projects	\$2.93
SCADA and Automation Enhancement	\$16.14
SCADA and Automation Refurbishment / Replacement	\$2.47
LV Network Safety Monitoring Program	\$21.10
Intelligent Grid Enablement	\$12.80
Common OTE	\$3.19
Total	\$100.58

Note: All financials presented in this document are correct at the time of writing and represent the existing organisational accounting treatment, which may be subject to change. Forecasted data is subject to ongoing variation due to COVID 19 impacts. Energy Queensland is finalising the alignment of its Cost Allocation Methodology between Ergon and Energex, potentially impacting the treatment of some Capital and Operational Project costs.

Appendix A

Terms and Definitions

Appendix A

Terms and Definitions

Abbreviations	
10 PoE	10% Probability of Exceedance (Peak load forecast based on normal expected growth which has a 10% probability of being exceeded in any year)
50 PoE	50% Probability of Exceedance (Peak load forecast based on normal expected growth which has a 50% probability of being exceeded in any year)
2HEC	Two Hour Emergency Capacity (of all equipment excluding the largest parallel element)
ABS	Australian Bureau of Statistics
ACS	Alternative Control Services
AEMC	Australian Energy Market Commission
AEMO	Australian Energy Market Operator
AER	Australian Energy Regulator
AFLC	Audio Frequency Load Control
AS	Australian Standard
BESS	Battery Energy Storage Systems
BMS	Business Management System
BOM	Bureau of Meteorology
Bus/es Busbar	A common connection point in a network substation or switchyard
CATS	Consumer Administration and Transfer Solution
C&I	Commercial and Industrial
CAPEX	Capital Expenditure
CB	Circuit Breaker
CBEMA	Computer and Business Equipment Manufacturers' Association
CBRM	Condition Based Risk Management
CCT	Abbreviation for Circuit
CIS	Customer Information System
COAG	Council of Australian Governments

Abbreviations

Code	Electricity Distribution Network Code
CRI	Community Regard Index
CVT	Capacitor Voltage Transformer
DA	Distribution Authority
DAPR	Distribution Annual Planning Report
DER	Distributed Energy Resources
DEPW	Department of Energy and Public Works
DMIA	Demand Management Incentive Allowance
DMIS	Demand Management Incentive Scheme
DMA	Distribution Monitoring Analytics
DMS	Distribution Management System
DNSP	Distribution Network Service Provider
DRED	Demand Response Enabling Device
EAM	Enterprise Asset Management
EBSS	Efficiency Benefits Sharing Scheme
ECC	Emergency Cyclic Capacity (for a substation this is the maximum cyclic rating of all equipment excluding the largest, resulting in an accelerated but acceptable rate of wear)
ENCAP	Electricity Network Capital Program Review 2011
EPBC	Environment Protection and Biodiversity Conservation Act
ERP	Enterprise Resource Planning
EV	Electric Vehicle
Feeder	Power line that can be any nominal voltage, overhead or underground.
FFA	Field Force Automation
FIT	Feed in Tariff/s
GIS	Geographical Information System or Gas Insulated Switchgear
GOC	Government Owned Corporation
GSL	Guaranteed Service Level
GSP	Gross State Product

Abbreviations

HEV	Hybrid Electric Vehicle
HV	High Voltage – alternating current voltage above 1,000 volts
IAM	Identity Access Management
ICT	Information and Communication Technology
IP/MPLS	Internet Protocol / Multi-Protocol Label Switching
ISO	International Organisation for Standardisation
IT	Information Technology
KPI	Key Performance Indicator
kV	Kilo-Volt or 1,000 volts
kVA	Kilo-Volt Ampere unit of power
LAR	Load at Risk
LARc	Load at Risk under Contingent Condition
LARn	Load at Risk under System Normal Condition
LDC	Line Drop Compensation
LV	Low Voltage (alternating current voltage above 50 volts and not exceeding 1,000 volts)
MAB	Metering Asset Base
MAIFI	Momentary Average Interruptions Frequency Index
MAIFie	Momentary Average Interruptions Frequency Index by Event
MAMP	Metering Asset Management Plan or Mains Asset Management Policy
MSS	Minimum Service Standard
MW	Mega-Watt unit of real power
MVA	Mega-Volt Ampere unit of power
MVA _r	Mega-Volt Ampere Reactive unit of reactive power
N-1	Security Standard where supply is maintained following a single credible contingency event
NCC	Normal Cyclic Capacity (for a substation this is the maximum cyclic rating of all parallel equipment resulting in a normal rate of wear)
NECF	National Energy Customer Framework
NEL	National Electricity Law

Abbreviations

NEM	National Electricity Market
NEO	National Electricity Objective
NER	National Electricity Rules
NIEIR	National Institute of Economic and Industry Research
NIM	Net Interstate Migration
NOM	Net Overseas Migration
NPV	Net Present Value
NSP	Network Service Provider
NVD	Neutral Voltage Displacement
OECD	Organisation for Economic Cooperation and Development
OLTC	On Load Tap Changer
OPEX	Operating Expenditure
OTE	Operational Technology Environment
PAR	Project Approval Report
PDH	Plesiochronous Digital Hierarchy
PHEV	Plug-in Hybrid Electric Vehicle
PMR	Pole mounted recloser
PoC	Power of Choice
PoE	Probability of Exceedance
POPS	Plant Overload Protection System
PoW	Program of Work
pu	Per-unit measure
PV	Photo Voltaic
QCA	Queensland Competition Authority
QECMM	Queensland Electrical Connection and Metering Manual
QHES	Queensland Household Energy Survey
QPC	Queensland Productivity Commission
RAB	Regulated Asset Base

Abbreviations

RBT	Rewards Based Tariff (project)
RDC	Remote Data Concentrators
RIT-D	Regulatory Investment Test for Distribution
RIT-T	Regulatory Investment Test for Transmission
RMU	Ring Main Unit
RTU	Remote Terminal Unit
Rules	National Electricity Rules
SAC	Standard Asset Customers
SACS	Substation Automation Control System
SAIDI	System Average Interruption Duration Index. (Performance measure of network reliability, indicating the total minutes, on average, that customers are without electricity during the relevant period)
SAIFI	System Average Interruption Frequency Index. (Performance measure of network reliability, indicating the average number of occasions each customer is interrupted during the relevant period)
SAMP	Substation Asset Maintenance Policy
SCS	Standard Control Services
SEQ	South East Queensland
SF6	Sulphur Hexafluoride
SCADA	Supervisory Control and Data Acquisition
SGT	Smart Grid Trials
SIFT	Substation Investment Forecast Tool
SPI	Service Performance Index
SSI	Sag Severity Indicator
Statcom	Static Synchronous compensator
STOC	SCADA & Telecommunications Operational Centre
STPIS	Service Target Performance Incentive Scheme
THD	Total Harmonic Distortion
ToU	Time-of-Use tariff
TMU	Target Maximum Utilisation

Abbreviations

TNSP	Transmission Network Service Provider
TSA	Telecommunication Supply Agreement
TSS	Tariff Structure Statement
UCC	Unified Communication and Collaboration
V	Volt or volts
VVR	Volt Var Regulation
WPF	Worst Performing Feeder
XLPE	Cross-Linked Polyethylene

Appendix B

NER and DA Cross Reference

Appendix B

NER and DA Cross Reference

NER Schedule 5.8 version 181 Clause / Sub-Clause	DAPR Section Number/Energex Terminology
For the purposes of clause 5.13.2(c), the following information must be included in a Distribution Annual Planning Report:	Note - the blue text denotes the Energex terminology used in the relevant section in Appendices
(a) information regarding the Distribution Network Service Provider and its network, including:	
(1) a description of its network;	1.2 Network Overview 2.2 Electricity Distribution Network
2) a description of its operating environment;	3 Community and Customer Engagement 9.1 Reliability Measures and Standards 9.2 Service Target Performance Incentive Scheme (STPIS) 9.3 High Impact Weather Events 10.3 Power Quality Supply Standards, Codes Standards and Guidelines 11 Network Challenges and Opportunities
(3) the number and types of its distribution assets;	2.2 Electricity Distribution Network
(4) methodologies used in preparing the Distribution Annual Planning Report, including methodologies used to identify system limitations and any assumptions applied; and	5.2 Planning Methodology 5.3 Key Drivers for Augmentation 5.4 Network Planning Criteria 5.6 Voltage Limits 5.7 Fault Level 5.10 Joint Planning 5.11 Network Planning – Assessing System Limitations 8.2.2 Asset Condition Management 9.2.1 STIPIS Results and Forecast
(5) analysis and explanation of any aspects of forecasts and information provided in the Distribution Annual Planning Report that have changed significantly from previous	1.5 Changes from Previous Year's DAPR

NER Schedule 5.8 version 181 Clause / Sub-Clause	DAPR Section Number/Energex Terminology
For the purposes of clause 5.13.2(c), the following information must be included in a Distribution Annual Planning Report:	Note - the blue text denotes the Energex terminology used in the relevant section in Appendices
<i>forecasts and information provided in the preceding year;</i>	
(b) forecasts for the forward planning period, including at least:	
<i>(1) a description of the forecasting methodology used, sources of input information, and the assumptions applied;</i>	4 Network Forecasting Appendix D Substations Forecast and Capacity Tables Appendix E Feeders Forecast and Capacity Tables
<i>(2) load forecast:</i>	4 Network Forecasting Appendix D Substations Forecast and Capacity Tables Appendix E Feeders Forecast and Capacity Tables
<i>(i) at the transmission-distribution connection points. Including, where applicable;</i>	Appendix D Substations Forecast and Capacity Tables 'Bulk Supply Substation'
<i>(iv) total capacity;</i>	'NCC Rating (MVA)'
<i>(v) firm delivery capacity for summer periods and winter periods;</i>	'ECC Rating (MVA)' '2HR Rating (MVA)'
<i>(vi) peak load (summer or winter and an estimate of the number of hours per year that 95% of peak load is expected to be reached);</i>	'Hours PA Exceeding 95% Peak Load'
<i>(vii) power factor at time of peak load;</i>	'Power Factor at Peak Load'
<i>(viii) load transfer capacities; and</i>	'Auto Trans Avail (MVA)' 'Remote Trans Avail (MVA)' 'Manual Trans Avail (MVA)' 'Mobile Plant Avail (MVA)'
<i>(ix) generation capacity of known embedded generating units;</i>	'Capacity of commissioned Embedded Generation (with Connection Agreements)'

NER Schedule 5.8 version 181 Clause / Sub-Clause	DAPR Section Number/Energex Terminology
For the purposes of clause 5.13.2(c), the following information must be included in a Distribution Annual Planning Report:	Note - the blue text denotes the Energex terminology used in the relevant section in Appendices
<i>(ii) for sub-transmission lines Including, where applicable:</i>	Appendix E Feeders Forecast and Capacity Tables
<i>(iv) total capacity;</i>	'NCC Rating (A)'
<i>(v) firm delivery capacity for summer periods and winter periods;</i>	'ECC Rating (A)' '2HR Rating (A)'
<i>(vi) peak load (summer or winter and an estimate of the number of hours per year that 95% of peak load is expected to be reached);</i>	'Hours PA Exceeding 95% Peak Load', Only applicable to sub – transmission lines which do not meet security standard.
<i>(vii) power factor at time of peak load;</i>	'Power Factor (System Normal)'
<i>(viii) load transfer capacities; and</i>	'Auto Trans Avail (A)' 'Remote Trans Avail (A)' 'Manual Trans Avail (A)'
<i>(ix) generation capacity of known embedded generating units.</i>	
<i>(iii) for zone substations including, where applicable:</i>	Appendix D Substations Forecast and Capacity Tables 'Zone Substation'
<i>(iv) total capacity;</i>	'NCC Rating (MVA)'
<i>(v) firm delivery capacity for summer periods and winter periods;</i>	'ECC Rating (MVA)' '2HR Rating (MVA)'
<i>(vi) peak load (summer or winter and an estimate of the number of hours per year that 95% of peak load is expected to be reached);</i>	'Hours PA Exceeding 95% Peak Load'
<i>(vii) power factor at time of peak load;</i>	'Power Factor at Peak Load'
<i>(viii) load transfer capacities; and</i>	'Auto Trans Avail (MVA)' 'Remote Trans Avail (MVA)' 'Manual Trans Avail (MVA)'

NER Schedule 5.8 version 181 Clause / Sub-Clause	DAPR Section Number/Energex Terminology
For the purposes of clause 5.13.2(c), the following information must be included in a Distribution Annual Planning Report:	Note - the blue text denotes the Energex terminology used in the relevant section in Appendices
	'Mobile Plant Avail (MVA)'
(ix) generation capacity of known embedded generating units.	'Capacity of commissioned Embedded Generation (with Connection Agreements)'
<p>(2A) forecast use of distribution services by embedded generating units:</p> <ul style="list-style-type: none"> (i) at the transmission-distribution connection points; (ii) for sub-transmission lines; and (iii) for zone substations, including, where applicable, for each item specified above: (iv) total capacity to accept supply from embedded generating units; (v) firm delivery capacity for each period during the year; (vi) peak supply into the distribution network from embedded generating units (at any time during the year) and an estimate of the number of hours per year that 95% of the peak is expected to be reached; and (vii) power factor at time of peak supply into the distribution network; 	<p>Appendix D Substations Forecast and Capacity Tables</p> <p>Appendix E Feeders Forecast and Capacity Tables</p>
(3) forecasts of future transmission-distribution connection points (and any associated connection assets), sub-transmission lines and zone substations, including for each future transmission-distribution connection point and zone substation:	<p>Appendix D Substations Forecast and Capacity Tables</p> <p>Appendix E Feeders Forecast and Capacity Tables</p> <p>Appendix C Network Limitations and Mitigation Strategies</p>
(i) location;	<p>6.5 Emerging Network Limitations Maps</p> <p>Appendix D Substations Forecast and Capacity Tables</p> <p>Appendix E Feeders Forecast and Capacity Tables</p> <p>Appendix C Network Limitations and Mitigation Strategies</p>

NER Schedule 5.8 version 181 Clause / Sub-Clause	DAPR Section Number/Energex Terminology
For the purposes of clause 5.13.2(c), the following information must be included in a Distribution Annual Planning Report:	Note - the blue text denotes the Energex terminology used in the relevant section in Appendices
<i>(ii) future loading level; and</i>	Appendix D Substations Forecast and Capacity Tables Appendix E Feeders Forecast and Capacity Tables
<i>(iii) proposed commissioning time (estimate of month and year);</i>	Appendix D Substations Forecast and Capacity Tables Appendix E Feeders Forecast and Capacity Tables Appendix C Network Limitations and Mitigation Strategies
<i>(4) forecasts of the Distribution Network Service Provider's performance against any reliability targets in a service target performance incentive scheme; and</i>	9.2 Service Target Performance Incentive Scheme (STPIS)
<i>(5) a description of any factors that may have a material impact on its network, including factors affecting;</i>	
<i>(i) fault levels;</i>	5.7 Fault Level
<i>(ii) voltage levels;</i>	5.6 Voltage Limits
<i>(iii) other power system security requirements;</i>	9.3 High Impact Weather Events
<i>(iv) the quality of supply to other Network Users (where relevant); and</i>	10.4 Power Quality Performance 2021-2022 11.1 Solar PV
<i>(v) ageing and potentially unreliable assets;</i>	8.1 Approach 8.2 Preventative Works 8.2.2 Asset Condition Management Appendix C Network Limitations and Mitigation Strategies
<i>(b1) for all network asset retirements, and for all network asset de-ratings that would result in a system limitation, that are planned over the forward planning period, the following information in sufficient detail relative to the size or significance of the asset:</i>	6.1.3 Asset Condition Limitations 8 Asset Life-Cycle Management Appendix C

NER Schedule 5.8 version 181 Clause / Sub-Clause	DAPR Section Number/Energex Terminology
For the purposes of clause 5.13.2(c), the following information must be included in a Distribution Annual Planning Report:	Note - the blue text denotes the Energex terminology used in the relevant section in Appendices
	Network Limitations and Mitigation Strategies
<i>(1) a description of the network asset, including location;</i>	
<i>(2) the reasons, including methodologies and assumptions used by the Distribution Network Service Provider, for deciding that it is necessary or prudent for the network asset to be retired or de-rated, taking into account factors such as the condition of the network asset;</i>	
<i>(3) the date from which the Distribution Network Service Provider proposes that the network asset will be retired or de-rated; and</i>	
<i>(4) if the date to retire or de-rate the network asset has changed since the previous Distribution Annual Planning Report, an explanation of why this has occurred;</i>	
<i>(b2) for the purposes of subparagraph (b1), where two or more network assets are:</i>	6.1.3 Asset Condition Limitations 8 Asset Life-Cycle Management Appendix C Network Limitations and Mitigation Strategies
<i>(1) of the same type;</i>	
<i>(2) to be retired or de-rated across more than one location;</i>	
<i>(3) to be retired or de-rated in the same calendar year; and</i>	
<i>(4) each expected to have a replacement cost less than \$200,000 (as varied by a cost threshold determination),</i>	
<i>those assets can be reported together by setting out in the Distribution Annual Planning Report:</i>	

NER Schedule 5.8 version 181 Clause / Sub-Clause	DAPR Section Number/Energex Terminology
<p>For the purposes of clause 5.13.2(c), the following information must be included in a Distribution Annual Planning Report:</p>	<p>Note - the blue text denotes the Energex terminology used in the relevant section in Appendices</p>
<p><i>(5) a description of the network assets, including a summarised description of their locations;</i></p>	
<p><i>(6) the reasons, including methodologies and assumptions used by the Distribution Network Service Provider, for deciding that it is necessary or prudent for the network assets to be retired or de-rated, taking into account factors such as the condition of the network assets;</i></p>	
<p><i>(7) the date from which the Distribution Network Service Provider proposes that the network assets will be retired or de-rated; and</i></p>	
<p><i>(8) if the calendar year to retire or de-rate the network assets has changed since the previous Distribution Annual Planning Report, an explanation of why this has occurred;</i></p>	
<p>(c) information on system limitations for sub-transmission lines and zone substations, including at least:</p>	<p>6 Overview of Network Limitations and Recommended Solutions</p> <p>6.1 Network Limitations – Adequacy, Security and Asset Condition</p> <p>5.6.2 Sub-transmission Network Voltage</p> <p>6.1.2 Sub-transmission and Distribution Feeder Capacity Limitations</p> <p>6.3 Summary of Emerging Network Limitations</p> <p>6.5 Emerging Network Limitations Maps</p> <p>Appendix D Substations Forecast and Capacity Tables</p> <p>Appendix E Feeders Forecast and Capacity Tables</p> <p>Appendix C Network Limitations and Mitigation Strategies</p>

NER Schedule 5.8 version 181 Clause / Sub-Clause	DAPR Section Number/Energex Terminology
For the purposes of clause 5.13.2(c), the following information must be included in a Distribution Annual Planning Report:	Note - the blue text denotes the Energex terminology used in the relevant section in Appendices
<i>(1) estimates of the location and timing (month(s) and year) of the system limitation;</i>	6 Overview of Network Limitations and Recommended Solutions Appendix D Substations Forecast and Capacity Tables Appendix E Feeders Forecast and Capacity Tables Appendix C Network Limitations and Mitigation Strategies
<i>(2) analysis of any potential for load transfer capacity between supply points that may decrease the impact of the system limitation or defer the requirement for investment;</i>	Appendix D Substations Forecast and Capacity Tables Appendix E Feeders Forecast and Capacity Tables
<i>(3) impact of the system limitation, if any, on the capacity at transmission-distribution connection points;</i>	Appendix D Substations Forecast and Capacity Tables Appendix E Feeders Forecast and Capacity Tables
<i>(4) a brief discussion of the types of potential solutions that may address the system limitation in the forward planning period, if a solution is required; and</i>	Appendix D Substations Forecast and Capacity Tables Appendix C Network Limitations and Mitigation Strategies
<i>(5) where an estimated reduction in forecast load would defer a forecast system limitation for a period of at least 12 months, include:</i>	Appendix D Substations Forecast and Capacity Tables Appendix E Feeders Forecast and Capacity Tables Appendix C Network Limitations and Mitigation Strategies
<i>(i) an estimate of the month and year in which a system limitation is forecast to occur as required under subparagraph (1);</i>	Appendix D Substations Forecast and Capacity Tables Appendix E Feeders Forecast and Capacity Tables

NER Schedule 5.8 version 181 Clause / Sub-Clause	DAPR Section Number/Energex Terminology
For the purposes of clause 5.13.2(c), the following information must be included in a Distribution Annual Planning Report:	Note - the blue text denotes the Energex terminology used in the relevant section in Appendices
	Appendix C Network Limitations and Mitigation Strategies
<i>(ii) the relevant connection points at which the estimated reduction in forecast load may occur; and</i>	Appendix D Substations Forecast and Capacity Tables Appendix E Feeders Forecast and Capacity Tables Appendix C Network Limitations and Mitigation Strategies
<i>(iii) the estimated reduction in forecast load in MW or improvements in power factor needed to defer the forecast system limitation;</i>	Appendix D Substations Forecast and Capacity Tables Appendix E Feeders Forecast and Capacity Tables Appendix C Network Limitations and Mitigation Strategies
<i>(d) for any primary distribution feeders for which a Distribution Network Service Provider has prepared forecasts of maximum demands under clause 5.13.1(d)(1)(iii) and which are currently experiencing an overload, or are forecast to experience an overload in the next two years the Distribution Network Service Provider must set out:</i>	5.6.3 11kV Distribution Network 6 Overview of Network Limitations and Recommended Solutions 6.1.2 Sub-transmission and Distribution Feeder Capacity Limitations 6.3 Summary of Emerging Network Limitations 6.5 Emerging Network Limitations Maps Appendix E Feeders Forecast and Capacity Tables Appendix C Network Limitations and Mitigation Strategies
<i>(1) the location of the primary distribution feeder;</i>	6 Overview of Network Limitations and Recommended Solutions 6.5 Emerging Network Limitations Maps Appendix E Feeders Forecast and Capacity Tables
<i>(2) the extent to which load exceeds, or is forecast to exceed, 100% (or lower utilisation factor, as appropriate) of the normal cyclic rating under normal</i>	Appendix E Feeders Forecast and Capacity Tables

NER Schedule 5.8 version 181 Clause / Sub-Clause	DAPR Section Number/Energex Terminology
For the purposes of clause 5.13.2(c), the following information must be included in a Distribution Annual Planning Report:	Note - the blue text denotes the Energex terminology used in the relevant section in Appendices
<i>conditions (in summer periods or winter periods);</i>	Appendix C Network Limitations and Mitigation Strategies
<i>(3) the types of potential solutions that may address the overload or forecast overload; and</i>	Appendix E Feeders Forecast and Capacity Tables Appendix C Network Limitations and Mitigation Strategies
<i>(4) where an estimated reduction in forecast load would defer a forecast overload for a period of 12 months, include:</i>	Appendix E Feeders Forecast and Capacity Tables Appendix C Network Limitations and Mitigation Strategies
<i>(i) estimate of the month and year in which the overload is forecast to occur;</i>	Appendix E Feeders Forecast and Capacity Tables Appendix C Network Limitations and Mitigation Strategies
<i>(ii) a summary of the location of relevant connection points at which the estimated reduction in forecast load would defer the overload;</i>	6 Overview of Network Limitations and Recommended Solutions 6.5 Emerging Network Limitations Maps Appendix C Network Limitations and Mitigation Strategies Appendix E Feeders Forecast and Capacity Tables
<i>(iii) the estimated reduction in forecast load in MW needed to defer the forecast system limitation;</i>	Appendix C Network Limitations and Mitigation Strategies Appendix E Feeders Forecast and Capacity Tables
<i>(d1) for any primary distribution feeders for which a Distribution Network Service Provider has prepared forecasts of demand for distribution services by embedded generating units under clause 5.13.1(d1)(3) and which are currently experiencing a system limitation, or are forecast to experience a system limitation in the next two years, the Distribution Network Service Provider must set out:</i>	Appendix E Feeders Forecast and Capacity Tables

NER Schedule 5.8 version 181 Clause / Sub-Clause	DAPR Section Number/Energex Terminology
<p>For the purposes of clause 5.13.2(c), the following information must be included in a Distribution Annual Planning Report:</p>	<p>Note - the blue text denotes the Energex terminology used in the relevant section in Appendices</p>
<p>(1) the location of the primary distribution feeder;</p> <p>(2) the extent to which demand for distribution services by embedded generating units exceeds, or is forecast to exceed, 100% (or lower utilisation factor, as appropriate) of the normal capacity to provide those distribution services under normal conditions;</p> <p>(3) the types of potential solutions that may address the system limitation or forecast system limitation;</p> <p>(4) where an estimated reduction in demand for distribution services by embedded generating units would defer a forecast system limitation for a period of 12 months, include</p> <p>(i) an estimate of the month and year in which the system limitation is forecast to occur;</p> <p>(ii) a summary of the location of relevant connection points at which the estimated reduction in demand for distribution services by embedded generating units would defer the system limitation; and</p> <p>(iii) the estimated reduction in demand for distribution services by embedded generating units in MW needed to defer the forecast system limitation;</p>	
<p>(e) a high-level summary of each RIT-D project for which the regulatory investment test for distribution has been completed in the preceding year or is in progress, including:</p>	<p>6.4 Regulatory Investment Test for Distribution (RIT-D) Projects</p> <p>Appendix C Network Limitations and Mitigation Strategies</p>
<p>(1) if the regulatory investment test for distribution is in progress, the current stage in the process;</p>	<p>Appendix C Network Limitations and Mitigation Strategies</p>
<p>(2) a brief description of the identified need;</p>	<p>Appendix C Network Limitations and Mitigation Strategies</p>

NER Schedule 5.8 version 181 Clause / Sub-Clause	DAPR Section Number/Energex Terminology
For the purposes of clause 5.13.2(c), the following information must be included in a Distribution Annual Planning Report:	Note - the blue text denotes the Energex terminology used in the relevant section in Appendices
<i>(3) a list of the credible options assessed or being assessed (to the extent reasonably practicable);</i>	Appendix C Network Limitations and Mitigation Strategies
<i>(4) if the regulatory investment test for distribution has been completed a brief description of the conclusion, including:</i>	Appendix C Network Limitations and Mitigation Strategies
<i>(i) the net economic benefit of each credible option;</i>	Appendix C Network Limitations and Mitigation Strategies
<i>(ii) the estimated capital cost of the preferred option; and</i>	Appendix C Network Limitations and Mitigation Strategies
<i>(iii) the estimated construction timetable and commissioning date (where relevant) of the preferred option; and</i>	Appendix C Network Limitations and Mitigation Strategies
<i>(5) any impacts on Network Users, including any potential material impacts on connection charges and distribution use of system charges that have been estimated;</i>	Appendix C Network Limitations and Mitigation Strategies
<i>(f) for each identified system limitation which a Distribution Network Service Provider has determined will require a regulatory investment test for distribution, provide an estimate of the month and year when the test is expected to commence;</i>	6.4.2 Foreseeable RIT-D Projects
<i>(g) a summary of all committed investments to be carried out within the forward planning period with an estimated capital cost of \$2 million or more (as varied by a cost threshold determination) that are to address an urgent and unforeseen network issue as described in clause 5.17.3(a)(1), including:</i>	5.10 Joint Planning 6.4 Regulatory Investment Test for Distribution (RIT-D) Projects Appendix C Network Limitations and Mitigation Strategies
<i>(1) a brief description of the investment, including its purpose, its location, the estimated capital cost of the investment and an estimate of the date (month and year) the investment is expected to become operational;</i>	Appendix C Network Limitations and Mitigation Strategies
<i>(2) a brief description of the alternative options considered by the Distribution</i>	5.10 Joint Planning

NER Schedule 5.8 version 181 Clause / Sub-Clause	DAPR Section Number/Energex Terminology
For the purposes of clause 5.13.2(c), the following information must be included in a Distribution Annual Planning Report:	Note - the blue text denotes the Energex terminology used in the relevant section in Appendices
<i>Network Service Provider in deciding on the preferred investment, including an explanation of the ranking of these options to the committed project. Alternative options could include, but are not limited to, generation options, demand side options, and options involving other distribution or transmission networks;</i>	Appendix C Network Limitations and Mitigation Strategies
(h) the results of any joint planning undertaken with a Transmission Network Service Provider in the preceding year, including:	
<i>(1) a summary of the process and methodology used by the Distribution Network Service Provider and relevant Transmission Network Service Providers to undertake joint planning;</i>	5.10 Joint Planning
<i>(2) a brief description of any investments that have been planned through this process, including the estimated capital costs of the investment and an estimate of the timing (month and year) of the investment; and</i>	5.10 Joint Planning
<i>(3) where additional information on the investments may be obtained;</i>	5.10 Joint Planning 5.10.5 Further Information on Joint Planning
(i) the results of any joint planning undertaken with other Distribution Network Service Providers in the preceding year, including:	
<i>(1) a summary of the process and methodology used by the Distribution Network Service Providers to undertake joint planning;</i>	5.10 Joint Planning
<i>(2) a brief description of any investments that have been planned through this process, including the estimated capital cost of the investment and an estimate of the timing (month and year) of the investment; and</i>	5.10.4 Joint Planning with other DNSP
<i>(3) where additional information on the investments may be obtained;</i>	5.10 Joint Planning

NER Schedule 5.8 version 181 Clause / Sub-Clause	DAPR Section Number/Energex Terminology
For the purposes of clause 5.13.2(c), the following information must be included in a Distribution Annual Planning Report:	Note - the blue text denotes the Energex terminology used in the relevant section in Appendices
<i>(j) information on the performance of the Distribution Network Service Provider's network, including:</i>	9 Network Reliability 10 Power Quality
<i>(1) a summary description of reliability measures and standards in applicable regulatory instruments;</i>	9.1 Reliability Measures and Standards 9.2 Service Target Performance Incentive Scheme (STPIS) 9.4 Guaranteed Service Levels (GSL) 9.5 Worst Performing Distribution Feeders
<i>(2) a summary description of the quality of supply standards that apply, including the relevant codes, standards and guidelines;</i>	10.3 Power Quality Supply Standards, Codes Standards and Guidelines
<i>(3) a summary description of the performance of the distribution network against the measures and standards described under subparagraphs (1) and (2) for the preceding year;</i>	9.1.1 Minimum Service Standard (MSS) 10.4 Power Quality Performance
<i>(4) where the measures and standards described under subparagraphs (1) and (2) were not met in the preceding year, information on the corrective action taken or planned;</i>	9.1.3 Reliability Compliance Process 9.1.4 Reliability Corrective Actions 10.5 Power Quality Ongoing Challenges and Corrective Actions
<i>(5) a summary description of the Distribution Network Service Provider's processes to ensure compliance with the measures and standards described under subparagraphs (1) and (2); and</i>	9.1.3 Reliability Compliance Process 10.1 Quality of Supply Processes
<i>(6) an outline of the information contained in the Distribution Network Service Provider's most recent submission to the AER under the service target performance incentive scheme;</i>	9.2 Service Target Performance Incentive Scheme (STPIS)
<i>(k) information on the Distribution Network Service Provider's asset management approach, including:</i>	2.4 Asset Management Overview
<i>(1) a summary of any asset management strategy employed by the Distribution Network Service Provider;</i>	2.4 Asset Management Overview 2.4.2 Asset Management Policy 8 Asset Life-Cycle Management

NER Schedule 5.8 version 181 Clause / Sub-Clause	DAPR Section Number/Energex Terminology
For the purposes of clause 5.13.2(c), the following information must be included in a Distribution Annual Planning Report:	Note - the blue text denotes the Energex terminology used in the relevant section in Appendices
<i>(1A) an explanation of how the Distribution Network Service Provider takes into account the cost of distribution losses when developing and implementing its asset management and investment strategy;</i>	5.4.4 Consideration of Distribution Losses
<i>(2) a summary of any issues that may impact on the system limitations identified in the Distribution Annual Planning Report that has been identified through carrying out asset management; and</i>	8 Asset Life-Cycle Management 11 Network Challenges and Opportunities
<i>(3) information about where further information on the asset management strategy and methodology adopted by the Distribution Network Service Provider may be obtained;</i>	2.4.6 Further Information 1.6 DAPR Enquiries
<i>(1) information on the Distribution Network Service Provider's demand management activities and activities relating to embedded generating units, including a qualitative summary of:</i>	
<i>(i) non-network options that have been considered in the past year, including generation from embedded generating units;</i>	7.4 What has the Energex DM Program delivered over the last year
<i>(ii) key issues arising from applications to connect embedded generating units received in the past year;</i>	7.5 Energex DM Program delivery over the next year
<i>(iii) actions taken to promote non-network proposals in the preceding year, including generation from embedded generating units; and</i>	7.4 What has the Energex DM Program delivered over the last year
<i>(iv) the Distribution Network Service Provider's plans for demand management and generation from embedded generating units over the forward planning period;</i>	7.5 Energex DM Program delivery over the next year
<i>(2) a quantitative summary of:</i>	
<i>(i) connection enquiries received under clause 5.3A.5; and of the total, the number for non-registered embedded generators;</i>	7.6.1 Connection Enquiries Received

NER Schedule 5.8 version 181 Clause / Sub-Clause	DAPR Section Number/Energex Terminology
For the purposes of clause 5.13.2(c), the following information must be included in a Distribution Annual Planning Report:	Note - the blue text denotes the Energex terminology used in the relevant section in Appendices
<i>(ii) applications to connect received under clause 5.3A.9; and of the total, the number for non-registered embedded generators;</i>	7.6.2 Applications to Connect Received
<i>(iii) the average time taken to complete applications to connect;</i>	7.6.3 Average Time to Complete Connection
(3) a quantitative summary of:	
<i>(i) enquiries under clause 5A.D.2 in relation to the connection of micro embedded generators or non-registered embedded generators; and</i>	7.6.1 Connection Enquiries Received
<i>(ii) applications for a connection service under clause 5A.D.3 in relation to the connection of micro embedded generators or nonregistered embedded generators;</i>	7.6.2 Applications to Connect Received
<i>(m) information on the Distribution Network Service Provider's investments in information technology and communication systems which occurred in the preceding year, and planned investments in information technology and communication systems related to management of network assets in the forward planning period; and</i>	12 Information Technology and Communication Systems 12.3 Metering 12.4 Operational and Future Technology
<i>(n) a regional development plan consisting of a map of the Distribution Network Service Provider's network as a whole, or maps by regions, in accordance with the Distribution Network Service Provider's planning methodology or as required under any regulatory obligation or requirement, identifying:</i>	6 Overview of Network Limitations and Recommended Solutions 6.5 Emerging Network Limitations Maps
<i>(1) sub-transmission lines, zone substations and transmission-distribution connection points; and</i>	6 Overview of Network Limitations and Recommended Solutions 6.5 Emerging Network Limitations Maps
<i>(2) any system limitations that have been forecast to occur in the forward planning period, including, where they have been identified, overloaded primary distribution feeders.</i>	6 Overview of Network Limitations and Recommended Solutions 6.5 Emerging Network Limitations Maps

NER Schedule 5.8 version 181 Clause / Sub-Clause	DAPR Section Number/Energex Terminology
For the purposes of clause 5.13.2(c), the following information must be included in a Distribution Annual Planning Report:	Note - the blue text denotes the Energex terminology used in the relevant section in Appendices
<p>(o) the analysis of the known and potential interactions between:</p> <p><i>(1) any emergency frequency control schemes, or emergency controls in place under clause S5.1.8, on its network; and</i></p> <p><i>(2) protection systems or control systems of plant connected to its network (including consideration of whether the settings of those systems are fit for purpose for the future operation of its network), undertaken under clause 5.13.1(d)(6), including a description of proposed actions to be undertaken to address any adverse interactions; and</i></p>	9.7 Emergency Frequency Control Schemes and Protection Systems
Other Rules including Distribution Authority (DA) obligations	DAPR Section Number/Energex Terminology
DA 10 Safety net	
DA 10.2 Safety net targets	
<p><i>(a) the distribution entity will design, plan and operate its supply network to ensure, to the extent reasonably practicable, that it achieves its safety net targets as specified in Schedule 3.</i></p>	<p>6 Overview of Network Limitations and Recommended Solutions</p> <p>Appendix D Substations Forecast and Capacity Tables</p> <p>Appendix E Feeders Forecast and Capacity Tables</p> <p>Appendix C Network Limitations and Mitigation Strategies</p>
<p><i>(b) from 1 July 2014 onwards, the distribution entity will, as part of its Distribution Annual Planning Report, monitor and report on the measures taken to achieve its safety net targets.</i></p>	<p>5.4.2 Safety Net</p> <p>9 Network Reliability</p> <p>Appendix D Substations Forecast and Capacity Tables</p> <p>Appendix E Feeders Forecast and Capacity Tables</p> <p>Appendix C Network Limitations and Mitigation Strategies</p>
<p><i>(c) from 1 July 2015 onwards, the distribution entity will, as part of its Distribution Annual</i></p>	Safety Net Target Performance

NER Schedule 5.8 version 181 Clause / Sub-Clause	DAPR Section Number/Energex Terminology
For the purposes of clause 5.13.2(c), the following information must be included in a Distribution Annual Planning Report:	Note - the blue text denotes the Energex terminology used in the relevant section in Appendices
<i>Planning Report, monitor and report on its performance against its safety net targets.</i>	
DA 11 Improvement programs	
DA 11.2 Requirements	
<i>(a) from 1 July 2014 onwards, the distribution entity will, as part of its Distribution Annual Planning Report, monitor and report on the reliability of the distribution entity's worst performing 11kV feeders;</i>	9 Network Reliability 9.5 Worst Performing Distribution Feeders Appendix F Worst Performing Distribution Feeders
DA 14.3 Requirements	
<i>From 1 July 2014 onwards, Distribution entity must report in its Distribution Annual Planning Reports on the implementation of its Distribution Network Planning Approach under clause 8 Distribution Network Planning.</i>	5 Network Planning Framework
DA 8.1 Requirements	
<i>Subject to clauses 9 Minimum Service Standards, 10 Safety Net and 11 Improvement Programs of this authority and any other regulatory requirements, the distribution entity must plan and develop its supply network in accordance with good electricity industry practice, having regard to the value that end users of electricity place on the quality and reliability of electricity services.</i>	5.4 Network Planning Criteria 9 Network Reliability 9.5 Worst Performing Distribution Feeders Appendix F Worst Performing Distribution Feeders

Appendix C

Network Limitations and Mitigation Strategies

Appendix C

Network Limitations and Mitigation Strategies

This section provides details on asset limitations and presents the committed solutions or the types of potential options for each of the limitations.

In comparison to the 2021 DAPR, some projects to address network limitations will have completed the regulatory process, or have entered construction, or have been commissioned. However, some projects identified in the 2021 DAPR have been deferred beyond the forward planning period due to declining growth in demand forecasts. Furthermore, some projects have been re-assessed and subsequently cancelled. This section provides updated information for the forward planning period.

Details on asset limitations and the types of potential options to address each of the limitations are contained in the Distribution System Limitation Template (prepared in accordance with Australian Energy Regulator's (AER) Distribution Annual Planning Report Template) via the following hyperlinks:

- [Substations Limitations and Proposed Solutions Capacity](#)
- [Substations Limitations and Proposed Solutions Refurbishment](#)
- [Transmission and Sub-Transmission Feeders Limitations and Proposed Solutions Capacity](#)
- [Transmission and Sub-Transmission Feeders Limitations and Proposed Solutions Refurbishment](#)

Details on limitations where Energex has committed projects to address can be accessed via the following hyperlinks:

- [Summaries of Replacement / Unforeseen Projects approved in the past 12 months](#)
- [Summaries of RIT-D Projects approved in the past 12 months](#)
- [Substations Limitations and Committed Solutions](#)
- [Transmission and Sub-Transmission Feeders Limitations and Committed Solutions](#)
- [Distribution Feeders Committed Solutions](#)

Details on limitations where Energex does not plan to address within the forward planning period can be obtained via the hyperlink below.

- [Limitations Not Addressed](#)

Further details can be obtained from the Energex website accessible via the following hyperlink:

[DAPR 2022](#)

Appendix D

Substations Forecast and Capacity Tables

Appendix D

Substations Forecast and Capacity Tables

The Substations Forecast and Capacity Tables is a summary of planning information for all existing and committed future bulk supply and zone substations. These are made available in spreadsheet format via the following hyperlinks:

- [Bulk Supply Substations Load Forecast](#)
- [Zone Substations Load and DER Forecast](#)
- [Joint Owned Substations Load Forecast](#)

In general, the summary includes only substations that supply multiple customers. Customer owned substations and substations dedicated to single large customers are not included.

Further details can be obtained from the Energex website accessible via the following link:

[DAPR 2022](#)

D.1 Supporting Notes

Each summary sheet contains a brief description of the substation, including its location, land area, construction type, installed transformers and capacity of known Embedded Generation connected to the substation. Localities give a general view of the areas serviced by the substation. Load categories indicate the type of loads supplied. Growth rates for the zone substations provide a projection of the expected growth rates for the next five years for planning purposes.

With respect to growth rates:

- None of the bulk supply substations directly supply customers, therefore there is no growth rates provided for these substations; and
- Large individual or block loads (existing and new) are treated on an individual basis and not listed in these substation summaries, but these are factored into load forecasts.

The next section includes a summary of performance and capability.

The latest compensated peak demand is displayed along with the typical daily compensated load profile. In addition, the compensated descriptor refers to the slightly reduced transformer load experienced when available capacitors are in service. Entries in the major loads section indicate there are significant or large customers connected to the substation. Both summer and winter profiles are presented where available. Where a substation has less than 12 months of metering data available, such as small substations and newly established substations, the graphs and the information against these fields is either blank or not applicable (N/A).

D.2 Peak Load Forecast and Capacity Tables

A definition of terms for these tables is shown in Table D1. These tables show information about the substation's customer category, transformer capacity, including emergency cyclic capacity and normal cyclic capacity, load at risk, and the compliance of each substation with its security standard. To assess whether a substation meets its security standard, four possible risk periods are considered: winter day, winter night, summer day and summer night. The highest risk period for each season is displayed for each year of the forward planning period.

A total of eight peak, reconciled and compensated load forecasts have been used in the analysis: 50 PoE summer (day & night); 50 PoE winter (day & night); 10 PoE summer (day & night); and 10 PoE winter (day & night). The summer forecasts are based on summer 2021/22 starting values, and the winter forecasts are based on winter 2023 starting values. Both sets of forecasts include load transfers expected from committed projects with the proposed timings scheduled in the Program of Work (PoW) as of June 2022. Substation capacities include the single contingency emergency cyclic capacity and the total substation normal cyclic capacity corresponding to the plant present at the start of the risk period. These ratings have also been adjusted for known committed project proposals.

The forecast and capacity cut-off date for the winter season is 1 June of each year, and for the summer season is 1 December of each year. For example, 2023 winter forecast includes all committed projects with a proposed commissioning date up to 1 June 2023, and the 2022/23 summer forecast includes all committed projects with a proposed commissioning date up to 1 December 2022.

The security standard applicable to a substation is based on the customer category. The peak risk period is the one with the highest calculated load at risk for normal or contingency conditions. Load at risk is calculated using the forecast loads, the planned substation capacity, and the capacity of the network to allow the transfer of load away from the substation to other sources of supply based on the substation security standard criteria. A detailed explanation of the derivation of load at risk is provided in Section E.2.1. If there is no load at risk, the substation meets the security standard.

Although transformers are usually the limiting factor for a substation's capacity, there are other significant items of plant, such as cables and switchgear that can also restrict capacity. Load sharing between parallel transformers can also be limited due to operational constraints (e.g. split bus configurations to manage fault levels) or differing transformer characteristics (e.g. tapping range or impedance differences). Both of these factors have been taken into account in the production of these tables.

Table D1 – Definition of Terms Peak Load Forecast and Capacity Tables

Term	Definition
Peak Risk Period	The time period over which the load is highest (Day/Night).
NCC Rating (MVA)	<p>Normal Cyclic Capacity – the total capacity with all network components and equipment in service.</p> <p>The maximum permissible peak daily loading for a given load cycle that plant can supply each day of its life. Taking impedance mismatch into consideration, it is considered the maximum rating for a transformer to be loaded under normal load conditions.</p>
Contracted non-network (MVA)	The amount of Embedded Generation and contracted curtailed demand management capacity available within the supply area of a substation during peak times. The impacts of these have been incorporated into the load forecasts. Solar PV connections are not included in the reported figure.
10 PoE Load (MVA)	Peak load forecast with 10% probability of being exceeded (one in every 10 years will be exceeded). Based on normal expected growth rates & weather corrected starting loads.
LARn (MVA)	Security standard load at risk under system normal condition, expressed in MVA.
LARn (MW)	Security standard load at risk under system normal condition, expressed in MW.
Power Factor at Peak Load	Compensated power factor at 50 PoE Load. Capacitive compensation is switched according to the size of the capacitor banks installed at the substation, compensation is generally limited to prevent a substation from going into leading power factor.
ECC Rating (MVA)	<p>Emergency Cyclic Capacity – the long term firm delivery capacity under a single contingent condition.</p> <p>The maximum permissible peak emergency loading for a given load cycle that an item of plant can supply for an extended period of time without unacceptable damage. For substations with multiple transformers, the ECC is the minimum emergency cyclic capacity of all transformer combinations taking impedance mismatches into consideration, with one transformer off line.</p>
50 PoE Load (MVA)	Peak load forecast with 50% probability of being exceeded (one in every two years will be exceeded). Based on normal expected growth rates and weather corrected starting loads.
50 PoE Load > 95% (MVA)	<p>The amount of load greater than 95% 50 PoE Load.</p> <p>(50 PoE Load – 0.95 x 50 PoE Load)</p>
Hours PA > 95% Peak Load	The number of hours per annum (maximum over the last 3 years) where the load exceeded 95% of the peak 50 PoE demand.
Raw LAR (MVA)	<p>The amount of load exceeding ECC rating.</p> <p>(50 PoE Load – ECC Rating)</p>

Term	Definition
2-Hour Rating (MVA)	<p>Two-Hour Emergency Capacity (2HEC) – the short term or firm delivery capacity under a single contingent condition.</p> <p>The maximum permissible peak emergency loading for a given load cycle that an item of plant can supply up to two hours without causing unacceptable damage. For substations with multiple transformers, the 2HEC is the minimum two hour emergency rating of all transformer combinations taking impedance mismatches into consideration, with one transformer offline.</p>
Auto Trans Avail (MVA)	<p>SCADA or automatically controlled load transfers that can be implemented within one minute.</p>
Remote Trans Avail (MVA)	<p>Load transfers that can be implemented through SCADA switching procedures by the network control officer. It is assumed that this can generally be achieved within 30 minutes excluding complex or time-consuming restoration procedures.</p>
Manual Trans Avail (MVA)	<p>Load transfers can also be deployed via manually controlled switchgear locally by field staff. It is assumed that the implementation of manual switching procedures to isolate the faulted portion of the network to restore supply to healthy parts of the network can be fully implemented within three hours (urban) or four hours (rural).</p> <p>Manual transfers are obtained from load flow studies performed on each 11kV distribution feeder based on the forecast 2020/21 load, the sum of all available 11kV transfers at a substation is multiplied by a 0.75 factor to account for diversity and to provide a margin of error to avoid voltage collapse. The same approach applies throughout the forward planning period.</p>
Mobile Plant Avail (MVA)	<p>The capacity of mobile substation or mobile generation that can be deployed within the timeframe prescribed by the security standard.</p> <p>The maximum allowable mobile generator capacity is limited to 4MVA for urban and 10MVA for rural. The maximum mobile substation capacity is 15MVA.</p>
POPS	<p>Plant Overload Protection Scheme consists of several applications which continuously monitor specific items of plant for overload conditions. If overload conditions are detected and validated, POPS will initiate predefined actions in order to relieve the overload condition.</p>
Bus Configuration	<p>An indication of the electrical configuration of the substation 11kV bus (e.g. split bus or solid bus)</p>
LARc (MVA)	<p>Security standard load at risk for single contingent conditions.</p>
LARc (MW)	<p>Estimated generation / load reduction required to defer the forecast system limitation. This is the security standard load at risk for a single contingency, expressed in MW.</p>
Customer Category	<p>For security standard application, the general type of customer a substation or feeder supplying the area.</p>

D.2.1 Calculation of Load at Risk

The load at risk is evaluated for both normal (LAR_n) and contingent (LAR_c) conditions. Under normal conditions, the loadings on a substation are not to exceed the normal cyclic capacity (NCC) of a major network component such as a zone substation transformer. Under contingent conditions, the loadings of a substation are not to exceed the available emergency supply under contingency whilst taking into consideration the security of supply standards of the substation.

Load at risk is the shortfall between the forecast load (either 10 PoE or 50 PoE) and the available supply. The general equations for LAR are as follows:

- **LAR_n** = 10 PoE – NCC where NCC is the normal cyclic capacity
- **LAR_c** = 50 PoE – available capacity – available supply (within security standard timeframe)

Network security standards are not being met if LAR_n or LAR_c is greater than 0.

Generally, there are two available capacities and five available sources of supply that can be deployed upon loss of a major network component such as a transformer.

Types of available capacity:

- **Emergency Cyclic Capacity (ECC)** – The maximum permissible peak emergency loading for a given load cycle that a plant can supply for an extended period of time without doing unacceptable damage. For substations with multiple transformers, the ECC is the minimum emergency cyclic capacity of all transformer combinations taking impedance mismatches into consideration, with one transformer offline.
- **Two Hour Emergency Capacity (2HEC)** – The maximum permissible peak emergency loading for a given load cycle that a plant can supply up to two hours without doing unacceptable damage. For substations with multiple transformer, the 2HEC is the minimum 2 hour emergency rating of all transformer combinations taking impedance mismatches into consideration, with one transformer offline. By the end of the 2 hours, the transformer load must be reduced to or below ECC.

Types of available supply:

- **Automatic Transfers (AT)** – SCADA or automatically controlled load transfers that can be implemented within 1 minute. Examples include auto changeover switching capacity from adjacent bus sections, standby transformers or via dedicated tie feeders from other substations. Such capacity has been considered at a number of substations where it is available.
- **Remote Transfers (RT)** – Load transfer capacity can be deployed via remotely controlled switchgear. The implementation of a series of SCADA controlled switching procedures to isolate the faulted portion of the network whilst restoring supply to fault free portions can be fully implemented within 30 minutes and is available for extended periods. At present, only remote transfers to other substations or standby transformers, using SCADA control of substation circuit breakers, have been considered.
- **Manual Transfers (MT)** – Load transfer capacity can be deployed via manually controlled switchgear. The implementation of a series of manual switching procedures to isolate the faulted portion of the network whilst restoring supply to fault free portions can be fully implemented within 3 hours (urban) or 4 hours (rural) and is available for extended periods. Some manual transfers are likely to be implemented within 2 hours but this has not been quantified at this time. Analysis done to identify the available 11kV transfer capability in the systems for every substation. To accommodate future 11kV network changes and system coincidence peak, a

75% factor is applied to ensure the transfers are practical and achievable throughout the analysis period. The manual switching of standby transformers, which do not have automatic switching, has also been included where available.

- **Mobile Generation (MG)** – Alternate supply from mobile generators can be sourced within 8 hours (urban) or 12 hours (rural). These are generally smaller 500kVA units that do not require transport permits or police escorts and can be rapidly deployed. Up to 4MVA (urban) or 10MVA (rural) of mobile generation may be committed to a single contingency event.
- **Mobile Substation (MS)** – Alternate supply provided through deployment of a mobile substation within 8 hours (urban and non-urban) – only applies to 33/11kV zone substation contingencies. These mobile substations generally do not require transport permits or police escorts and can be rapidly deployed. The standard size of the mobile substation transformer is 18MVA however a capacity of 15MVA is used in the assessment of zone substation security standard compliance. Use of the mobile substation may be committed to a single contingency event.

D.2.2 Network Security Standards

The network security standards are outlined in 5.4.2. is referred to as the Safety Net. This safety net approach complies with jurisdictional obligations. In compliance with the Distribution Authority, CBD applies to predominantly commercial high-rise buildings using high voltage underground network with significant inter-connection when compared to urban areas. Whereas, urban applies to non-CBD areas predominantly supplying actual maximum demand per total feeder route length of greater than 0.3MVA per km. rural then applies to non-CBD and non-urban areas.

Appendix E

Feeders Forecast and Capacities Tables

Appendix E

Feeders Forecast and Capacity Tables

The Feeders Forecast and Capacity Tables contains the capacity and forecast loads on the 132kV, 110kV, 33kV and 11kV feeders in the Energex network.

These are made available in spreadsheet format via the following hyperlinks:

- [11kV Feeders Summer and Winter Forecast](#)
- [33kV Feeders Summer Forecast](#)
- [33kV Feeders Winter Forecast](#)
- [110kV and 132V Feeders Summer Forecast](#)
- [110kV and 132kV Feeders Winter Forecast](#)
- [11kV DER Forecast](#)
- [33kV DER Forecast](#)
- [110kV and 132kV DER Forecast](#)

In general, the tables contain only feeders that supply multiple customers. Dedicated feeders that supply single large customers are not included.

Further details can be obtained from the Energex website accessible via the following link:

[DAPR 2022](#)

E.1 Supporting Notes on Feeders

The following sections list the 132kV, 110kV, 33kV and 11kV feeders, their forecast loads and their capacity limitations. The feeder loads are calculated from load flow results using forecast substation demands. For the transmission and sub-transmission feeders, load flow studies are conducted for system normal and single contingency situations. For 11kV feeders, studies are conducted under normal conditions. The limitation tables provide details on feeders having a capacity limitation, and present the most likely solution to address the limitation.

E.2 Peak Load Forecast and Capacity Tables

A definition of terms for these tables is shown in Table E1. These tables show information about the feeder capacity, load at risk, and the compliance of each feeder with its security standard. To assess whether a feeder meets its security standard, four possible risk periods are considered: winter day, winter night, summer day and summer night. The highest risk period for each season is displayed for each year of the forward planning period.

The forecast and capacity cut-off date for the winter season is 1 June of each year, and for the summer season is 1 December of each year. For example, the 2023 winter forecast includes all committed projects with a proposed commissioning date up to 1 June 2023, and the 2022/23 summer forecast includes all committed projects with a proposed commissioning date up to 1 December 2022.

Assessment of 33kV feeders is performed under four possible risk periods: winter day, winter night, summer day and summer night.

Due to the modelling complexity of the 132kV and 110kV, two dominant risk periods are considered in the analysis: summer day and winter night.

Peak, reconciled, compensated load forecasts have been used in the 132kV and 110kV and 33kV feeder analyses, with 50 PoE forecast load used for single contingency studies, and 10 PoE forecast load used for system normal studies. The analysis includes load transfers expected from committed projects with the proposed timings scheduled in the Program of Work (PoW) as of June 2022, and the 132kV and 110kV studies are based on the summer 2022/23 Queensland peak generation scenario⁴⁷.

Feeder capacities are shown for ECC and NCC. These ratings have also been adjusted for known committed project proposals. All load transfers associated with contingent condition include acceptable feeder voltage profiles.

Although the conductor rating is generally the limiting factor for feeder capacity, there are other significant items of plant, such as the feeder circuit breaker, that can also restrict capacity. Furthermore, other factors such as voltage constraints and load sharing between parallel underground feeders can sometimes de-rate the capacity of the feeders due to thermal characteristic constraints. Each of these factors has been taken into account in the production of the forecast tables.

Interconnected or feeders that supply multiple customers are examined in the following tables. Feeders exclusively supplying a customer owned substation or dedicated to a customer are not included in these tables.

E.2.1 Distribution (11kV) Feeder Studies

For the 11kV feeder studies, the 50 PoE and 10 PoE load forecasts are assessed based on the 2022 winter and 2021/22 summer starting values, and include some load transfers expected from approved project proposals as at June 2022. The forecast winter loads are for the winter season following the summer quoted in that financial year. The 50 PoE load forecasts and the normal cyclic capacity of feeder rating are then used to determine limitations. Where projects have been approved to augment a feeder, the augmented rating has been used in the analysis. Permanent remediation strategies to correct network limitations beyond those resolved via approved projects have not been modelled in the study as these are developed year by year.

Instead of load at risk calculations, the analysis compares feeder utilisation under normal conditions against the acceptable levels of utilisation specific to each feeder. The target utilisation assigned to each feeder depends on its configuration, with radial feeders tending to have higher utilisations of about 80% and balanced three feeder meshes such as those typically found in the CBD having target utilisations of 67%. This approach accommodates the different purposes to which feeders may be employed (e.g. dedicated to single point customer loads, ties or dual feeders). This utilisation is calculated according to the following:

- Utilisation (Normal Conditions) = 50 PoE Load / NCC Rating

⁴⁷ The Queensland peak generation scenario is sourced from Powerlink Queensland using committed generation only, which is based on sample generation dispatch patterns to meet forecast Queensland Region demand conditions.

- The conditions used to determine security are as follows:
- If Utilisation > Target Utilisation ⇒ site does not meet security standard

Table E1 – Definition of Terms Feeder Capacity and Forecast Tables

Term	Definition
NCC Rating (A)	<p>Normal Cyclic Capacity - the total capacity with all network components and equipment intact.</p> <p>This is the maximum permissible peak daily loading for a given load cycle that a feeder can supply each day of its life. For overhead feeders, the NCC is the conductor rating with an assumed 1m/s wind, orthogonal to the line. For underground cables, the NCC assumes that there are sufficient temperature and current operating margins from the thermal inertia of the cable and its surroundings.</p>
10 PoE Load (A)	Peak load forecast with 10% probability of being exceeded (one in every 10 years will be exceeded). Based on normal expected growth rates and weather corrected starting loads.
Power Factor (System Normal)	Lowest power factor along the feeder at 10 PoE Peak Load.
LARn (A)	Security standard load at risk under system normal condition, expressed in Amps.
LARn (MW)	<p>Security standard load at risk under system normal condition, expressed in MW, assuming the nominal system voltages and lowest power factor.</p> $\frac{(\text{LARn (A)} \times \text{Nominal Voltage} \times \text{Power Factor (System Normal)} \times \text{sqrt}(3))}{1000000}$
ECC Rating (A)	<p>Emergency Cyclic Capacity – the long term firm delivery capacity under single contingency conditions.</p> <p>Some underground cables are installed in close proximity to other circuits and are normally de-rated to allow for the heat generated by the adjacent cables. ECC is the higher capacity available when any adjacent circuits have been unloaded. For overhead conductors which do not benefit from this phenomenon, the ECC is synonymous with the NCC.</p>
50 PoE Load (A)	Peak load forecast with 50% probability of being exceeded (one in every two years will be exceeded). Based on normal expected growth rates & weather corrected starting loads.
Hours PA > 95% Peak Load	The forecast number of hours per annum where the load exceeded 95% of the peak 50 PoE demand.

Term	Definition
Raw LAR (A)	The amount of load exceeding ECC rating. (Load – ECC Rating)
2-Hour Rating (A)	<p>Two Hour Emergency Capacity (2HEC) – the short term firm delivery capacity under single contingency conditions.</p> <p>For overhead feeders, the 2HEC is the conductor rating with an assumed 2m/s wind, orthogonal to the line (compared to the 1.0 m/s wind speed used for NCC ratings).</p> <p>For underground cables, the 2HEC assumes that there are sufficient temperature and current operating margins immediately prior to the contingency to extract additional capacity from the thermal inertia of the cable and its surrounds.</p>
Auto Trans Avail (A)	<p>SCADA or automatically controlled load transfers that can be implemented within one minute. Examples include auto changeover switching to alternate feeders.</p> <p>A blank entry indicates that this type of transfer is not considered as available in the evaluation of security standard compliance.</p>
Remote Trans Avail (A)	<p>Load transfers that can be implemented through SCADA switching procedures by the network control officer. It is assumed that this can generally be achieved within 30 minutes.</p> <p>A blank entry indicates that this type of transfer is not considered as available in the evaluation of security standard compliance.</p>
Manual Trans Avail (A)	<p>Load transfers can also be deployed via manually controlled switchgear locally by field staff. It is assumed the implementation of manual switching procedures to isolate the faulted portion of the network whilst restoring supply to fault free portions can be fully implemented within three hours (urban) or four hours (rural).</p> <p>Manual transfers are obtained from load flow studies performed on each 11kV distribution feeder based on the forecast 2016/17 load, the sum of all available 11kV transfers at a substation is multiplied by a 0.75 factor to account for diversity and to provide an error margin. The same amount of transfers is applied throughout the forward planning period.</p> <p>A blank entry indicates that this type of transfer is not considered as available in the evaluation of security standard compliance.</p>

Term	Definition
POPS	Plant Overload Protection Scheme (POPS) consists of several applications which continuously monitor specific items of plant for overload conditions. If overload conditions are detected and validated, POPS will initiate predefined actions in order to relieve the overload condition.
Mobile Gen Reqd (A)	<p>The amount of generation required under the contingency, capped at the maximum MVA allowable under the security standard requirements.</p> <p>Where required, alternate supply from mobile generators can be sourced within 8 hours (urban) or 12hours (rural). These are generally smaller 500kVA units that do not require transport permits or police escorts and can be rapidly deployed. Up to 4MVA (urban) or 10MVA (rural) of mobile generation may be committed to a single contingency event.</p>
LARc (A)	Security standards load at risk under single contingency condition, expressed in Amps.
LARc (MW)	<p>Estimated generation / load reduction required to defer the forecast system limitation.</p> <p>This is the security standard load at risk under single contingency condition, expressed in MW, assuming the nominal system voltages and the lowest power factor on the feeder under system normal condition.</p> $\frac{(\text{LARc (A)} \times \text{Nominal Voltage} \times \text{Power Factor (System Normal)} \times \text{sqrt}(3))}{1000000}$
Customer Category	For security standard application, the general type of customer a sub-transmission, or transmission feeder is supplying.

E.2.2 Network Security Standards

The network security standards are outlined in 5.4.2. is referred to as the Safety Net. This safety net approach complies with jurisdictional obligations. In compliance with the Distribution Authority, CBD applies to predominantly commercial high-rise buildings using high voltage underground network with significant inter-connection when compared to urban areas. Whereas, urban applies to non-CBD areas predominantly supplying actual maximum demand per total feeder route length of greater than 0.3MVA per km. Rural then applies to non-CBD and non-urban areas.

E.2.3 Available Transfers

As per the Safety Net, there is an implied 4MVA of remote generation automatically available for feeders classified as Urban, and 10MVA for feeders classified as Rural. The load transfers shown in the forecast table have these values as their default values. Where under a contingency the load and these default

transfers exceeds the ECC rating of the feeder, specific load transfers are calculated to determine whether a feeder meets the Safety Net, or is a limitation.

Appendix F

Worst Performing Distribution Feeders

Appendix F

Worst Performing Distribution Feeders

The Worst Performing Distribution Feeders contains the 2021/22 Worst Performing Distribution Feeder table. This is available in spreadsheet format via the following hyperlinks:

- [2021-22 Review of Worst Performing Distribution Feeders](#)

Further details can be obtained from the Energex website accessible via the following link:

[DAPR 2022](#)



energex.com.au

Energex Limited
ABN 40 078 849 055