

Transmission Pricing Methodology

2024-2029 Regulatory Control Period

Contents

1	Introduction	5
1.1	Introduction to TasNetworks	5
1.2	Pricing methodology introduction	5
1.3	Interpretation	5
2	Transmission pricing context	6
2.1	Pricing methodology changes	7
3	Prescribed transmission services	10
4	Rules and Guidelines requirements	11
4.1	Rules requirements	11
4.2	Pricing methodology guidelines requirements	13
5	TasNetworks' pricing methodology	16
5.1	Background	16
5.2	Single transmission network service provider	16
5.3	Aggregate annual revenue requirement	16
5.4	Categories of transmission services	18
5.5	The pricing process	18
5.6	System Strength Charges	31
5.7	Standby service arrangements	34
5.8	Excess demand charge	35
5.9	Setting of prescribed TUOS services locational prices between annual price publications	35
6	Billing arrangements	36
7	Prudential requirements	38
7.1	Prudential requirements for prescribed transmission services	38
7.2	Capital contribution or prepayment for a specific asset	38
8	Prudent discounts	39
9	Inter-regional transmission charging	40
10	Monitoring and compliance	41
11	New connections requiring significant investment	42
11.1	Impact on TUOS locational prices in cases of significant investment	42
11.2	Setting TUOS locational prices in the first year of significant investment	42
12	Additional information requirements	43



13	Conclusion	44
	Appendix A: Overview of pricing process	45
	Appendix B: Details of cost allocation process	46
	Appendix C: Cost reflective network pricing methodology	48
	Appendix D: Priority ordering methodology	50
	Appendix E: Examples of application of priority ordering process	55
	Appendix F: Inter-regional transmission charging	65
	Appendix G: System strength charges	72

1 Introduction

1.1 Introduction to TasNetworks

TasNetworks is a State Government owned business that owns and operates Tasmania's electricity network. While in other parts of the country the ownership of transmission and distribution networks is generally separated, in Tasmania TasNetworks provides both transmission and distribution network services. With total assets of over \$3 billion, TasNetworks provides the electricity network that ensures our customers receive safe, reliable and affordable electricity supply of renewable energy.

TasNetworks' transmission services transmit high voltage power from generators, e.g. hydro-electric power stations and wind farms, and delivers it to the distribution network and a number of large commercial and industrial users of electricity who are directly connected to our transmission network.

1.2 Pricing methodology introduction

As relevant for this *pricing methodology*, TasNetworks is the *Transmission Network Service Provider* (TNSP) and the *System Strength Service Provider* in Tasmania.

This *pricing methodology*, for the regulatory period from 1 July 2024 to 30 June 2029, forms part of TasNetworks' 2024-2029 Revenue Proposal and is submitted to the Australian Energy Regulator (AER) for approval in accordance with the requirements of chapter 6A and of the National Electricity Rules (the *Rules* or NER)¹ and the *AER's Pricing Methodology Guidelines*.²

This *pricing methodology* incorporates new Rule requirements, minor changes, and additional context when compared to the *pricing methodology* that was approved by the AER for the 2019-2024 *regulatory control period*.

1.3 Interpretation

All terms in this *pricing methodology* that are italicised have the meaning given to them in the *Pricing Methodology Guidelines* or, where no definition is provided in that document, the *Rules*.

¹ Version 192, which commenced on 1 December 2022

² AER, Final, Electricity transmission network service providers, Pricing methodology guidelines, 25 August 2022.

2 Transmission pricing context

Solar and wind generation have, in recent years, been a primary source of the growth in renewable energy generation across Australia. The use of hydro-electric generation is an additional component to Tasmania’s renewable energy generation mix.

Tasmania seeks to become a “Renewable Energy Powerhouse³”, doubling our renewable energy generation to 200 per cent of 2022 amounts by 2040, equivalent to an additional 10,500 GWh of renewable energy generation. The Tasmanian Government has legislated this Tasmanian Renewable Energy Target⁴. Both the State and Commonwealth Governments have provided support for the development of Marinus Link and a renewable hydrogen industry in Tasmania. The large-scale investment projects and changing generation mix have informed the development of TasNetworks’ 2024-2029 *Pricing Methodology*.

These developments represent a significant step change in the generation and transmission of electricity across Tasmania and the ability to export to the mainland. TasNetworks’ future plans for the transmission network incorporate:

- the development of the transmission network in Tasmania’s North West to support the proposed Marinus Link undersea interconnector with Victoria;
- supporting the proposed hydrogen production facilities in the Bell Bay Advanced Manufacturing Zone; and
- the delivery of transmission augmentations to facilitate energy transfers for additional renewable energy generation and load growth.

Tasmania’s Renewable Energy Zones

Tasmania has a high quality wind resource, and our wind farm development potential is significant. AEMO’s Integrated System Plan has identified this significant resource. Establishment of Renewable Energy Zones (REZ) in Tasmania will facilitate the efficient and coordinated delivery of additional wind generation capacity, which will be key to the achievement of the Tasmanian Renewable Energy Target.

In addition, Marinus Link and the North West transmission developments will enable a range of other energy projects to come online, such as pumped hydro energy storage. The Battery of the Nation initiative is investigating future opportunities for Tasmania to make a greater contribution to the National Energy Market (NEM).

Bell Bay Advanced Manufacturing Zone⁵

A future hydrogen economy is creating opportunities for Tasmania to use existing and future renewable energy generation along with our water resources to become a global competitor in large-scale green hydrogen production by 2030. This future industry is supported by the Tasmanian Government’s Renewable Hydrogen Industry Development Funding Program. The

³ [Premier of Tasmania - Continuing our plan to be a Renewable Energy Powerhouse](#), 19 December 2020

⁴ The Tasmanian Renewable Energy Target is established in the *Energy Co-ordination and Planning Act 1995*

⁵ TasNetworks Annual Planning Report 2022

Bell Bay Advanced Manufacturing Zone and North West Tasmania are potential areas for a large-scale renewable hydrogen production.

Transmission augmentations

There are several transmission augmentations that are expected to be required to facilitate energy flows as necessary to achieve the Tasmanian Renewable Energy Target and load growth ambitions (driven by the development of a hydrogen industry). These projects are captured in TasNetworks' proposed contingent projects for 2024-2029 *regulatory control period*.

2.1 Pricing methodology changes

TasNetworks has reviewed and considered the *Rules* in developing this methodology. This has resulted in proposed changes to apply in our transmission pricing methodology, namely the:

- Efficient management of system strength on the power system⁶ (new rule);
- Reallocation of national transmission planner costs⁷ (new rule);
- Co-ordinating network service provider (existing arrangements to be more clearly outlined);
- Integrating energy storage systems into the NEM⁸ (new rule); and
- Recovering the cost of AEMO's participant fees⁹ (new rule).

2.1.1 System strength

System strength is the measure of a power system's ability to remain stable. It is critical for the delivery of reliable and safe electricity, including being able to accommodate the increasing amounts of inverter-based generation that will be connected to the network.

The system strength mitigation requirement has evolved to establish a new charging mechanism – the system strength charge (**SSC**). Those parties who use system strength services will now pay for them. The system strength charge will be determined to meet the system strength standard and will vary by the location in the network and the amount of system strength the connecting party will use. Connecting parties have the option of paying the system strength charge or by self-remediating their own system strength impacts following a full impact assessment of the connection being undertaken by TasNetworks as the relevant network service provider.

Section 5.5.5.4 describes how TasNetworks will forecast *annual system strength revenue*, which is an important input in determining common service charges.

⁶ National Electricity Amendment (Efficient management of system strength on the power system) Rule 2021

⁷ National Electricity Amendment (Reallocation of National Transmission Planner costs) Rule 2020

⁸ National Electricity Amendment (Integrating energy storage systems into the NEM) Rule 2021

⁹ National Electricity Amendment (Recovering the cost of AEMO's participant fees) Rule 2022

Section 5.6.2 of this document sets out how TasNetworks will calculate the *system strength unit price (SSUP)*. The SSUP is a dollar per MVA amount that reflects the forward-looking cost of supplying system strength at each relevant point in Tasmania’s transmission network (*system strength nodes*).

As required under clause 11.143.5 of the NER, TasNetworks proposed amendments to its approved 2019-24 *Pricing Methodology* to incorporate the new system strength charging framework. These changes are also incorporated in this *pricing methodology* for the 2024-2029 *regulatory control period*.

2.1.2 Reallocation of national transmission planner costs

The AEMC has established arrangements for National Transmission Planner (**NTP**) costs (*NTP function fees*) to be allocated to CNSPs, and associated arrangements for these costs to be recovered from customer through non-locational charges.

2.1.3 Co-ordinating Network Service Provider

TasNetworks is currently the sole TNSP in Tasmania, and is therefore the sole provider of prescribed transmission services within Tasmania.

However, as noted in section 2, Tasmania is seeking to become a renewable energy powerhouse. To realise this ambition, this additional renewable energy generation will be supplied to the rest of the NEM through the proposed Marinus Link. It is estimated that Marinus Link could be in service during the next *regulatory control period* (2024-2029).

Where there is more than one TNSP within a region, a Co-ordinating Network Service Provider (**CNSP**) is appointed by the multiple TNSPs to allocate the aggregate annual revenue requirement (**AARR**), which is outlined in section 4.1.2, and to calculate and allocate the modified load export charges (**MLEC**).

Section 4.1.3 outlines how TasNetworks proposes to include the requirements of a CNSP during the next *regulatory control period*, should there be multiple TNSPs operating within Tasmania and TasNetworks is appointed the CNSP for the Tasmanian region.

2.1.4 Integrating energy storage systems

Following the AEMC’s final determination on the Integrating Energy Storage Systems into the NEM rule change, a new class of participant termed integrated resource provider (**IRP**) has been introduced into the NER. Operators of any *bidirectional units* will need to register as an IRP. *Bidirectional units* include batteries and pumped hydro.

Storage participants have a choice as to the service they wish to receive – including *negotiated transmission service* or *prescribed transmission services*. If a customer requests to take supply as a *prescribed transmission service* both the load and generation will be treated separately, with the load being treated as per section 5 of this pricing methodology and generation being treated as a *negotiated transmission service* (or as otherwise agreed between TasNetworks and the customer).

A service which is not a *prescribed transmission service* (which may be for either load and generation, or solely for generation where load is being treated as a *prescribed transmission service*) will be managed outside this pricing methodology.

2.1.5 Recovering the cost of AEMO's participant fees

The AEMC determined transitional arrangements that will apply for TasNetworks for the 2024-2029 *regulatory control period*. These transitional arrangements require TasNetworks to pass through participant fees, as determined by *AEMO*, through non-locational transmission charges.

3 Prescribed transmission services

TasNetworks' *pricing methodology* relates to the provision of *prescribed transmission services* in Tasmania by TasNetworks. These services include:

- *shared transmission services* provided to customers directly connected to the *transmission network* and connected *Network Service Providers (prescribed transmission use of system (TUOS) services)*;
- *connection services* provided to connect the *distribution network* to the *transmission network (prescribed exit services)*;
- grandfathered *connection services* provided to *Generators* and customers directly connected to the *transmission network* for *connections* that were in place or committed to be in place on 9 February 2006 (*prescribed entry services* and *prescribed exit services*);
- services that provide equivalent benefits to all *Transmission Customers* without any differentiation based on their location, and therefore cannot be reasonably allocated on a locational basis (*prescribed common transmission services*); and
- *System strength transmission services*, which is the provision of facilities or services to meet the standard in clause S5.1.14 at *system strength nodes*. *System strength transmission services* are classified as *prescribed common transmission services*.

TasNetworks' *pricing methodology* does not relate to the provision of *negotiated transmission services* or other *transmission services* provided by TasNetworks that are not subject to economic regulation under the *Rules (non-regulated transmission services)*.

4 Rules and Guidelines requirements

4.1 Rules requirements

Clause 6A.24.1(b) of the *Rules* states that a *pricing methodology* is a methodology, formula, process or approach that, when applied by a *Transmission Network Service Provider*:

- (1) allocates the *aggregate annual revenue requirement* for *prescribed transmission services* provided by the *Transmission Network Service Provider* to each *category of prescribed transmission services*;
- (2) provides for the manner and sequence of adjustments to the *annual service revenue requirement*;
- (3) allocates the *annual service revenue requirement* to *transmission network connection points* (other than connection points of any *Market Network Service Provider*); and
- (4) determines the structure and recovery of prices for each *category of prescribed transmission services* under 6A.23.4(a).

In addition to complying with any other requirements of Chapter 6A of the NER, clause 6A.24.1(b1) of the *Rules* requires that the *pricing methodology* of a *TNSP* that has been appointed as a *CNSP* for a region must provide for¹⁰:

- (1) the allocation of the *AARR* for *prescribed transmission services* provided by *TNSPs* within that *region*, including any allocation of the *AARR* as agreed between *TNSPs* in accordance with clause 6A.29.3;
- (2) the calculation of *modified load export charges (MLEC)* consistent with clause 6A.29A.2;
- (3) the allocation and billing of *MLEC*:
 - i. receivable by other *CNSPs* in *interconnected regions*; and
 - ii. payable to other *CNSPs* in *interconnected regions*;
 to each *TNSP* within its *region* under clause 6A.29A.5; and
- (4) the allocation of proceeds from *auctions* or a portion of the *settlements residue* receivable by or payable to the *TNSP* in its *region* as referred to in clause 6A.23.3(b)(1)

The *Rules* also require that the *pricing methodology* satisfies principles and guidelines established by the *Rules*. In particular, clause 6A.10.1(e) of the *Rules* requires that a proposed *pricing methodology* must:

¹⁰ For instance, clause 6A.24.1(b1) would apply if TasNetworks was appointed as a *CNSP* as a result of Mariner Link becoming a regulated interconnector during the 2024-2029 *regulatory control period*.

- (1) give effect to and be consistent with the *Pricing Principles for Prescribed Transmission Services*; and
- (2) comply with the requirements of, and contain or be accompanied by such information as is required by, the *pricing methodology guidelines* made for that purpose under rule 6A.25.

Further, under clause 6A.24.1(d) of the *Rules* a *Transmission Network Service Provider* must comply with the *pricing methodology* approved by the *AER* as part of a *transmission determination* that applies to that *Transmission Network Service Provider*, and any other applicable requirements in the *Rules*, when the *Transmission Network Service Provider* is setting the prices that may be charged for the provision of *prescribed transmission services*.

If the interconnector becomes regulated during the 2024-2029 *regulatory control period*, and where Chapter 6A of the *Rules* provides that a matter is to be determined in accordance with the *pricing methodology* of a *TNSP*, who is the *CNSP* for a region, then no other *pricing methodology* applies in relation to that matter¹¹.

4.1.1 Single Transmission Network Service Provider

TasNetworks is currently the sole provider of *prescribed transmission services* within Tasmania and is responsible for the allocation of the *AARR* within Tasmania¹².

Therefore, where there is only one *TNSP* of *prescribed transmission services* within a region, references within the *Rules* to a *CNSP* is to be read as a reference to that *TNSP*¹³.

In the event that *prescribed transmission services* within Tasmania are provided by more than one *TNSP*, (as discussed in Section 2.1.3 of this document), and TasNetworks is appointed as the *CNSP*, revenues will be allocated and collected for any other *TNSP*¹⁴.

4.1.2 Coordinating network service provider

Should TasNetworks be appointed as the *CNSP* for the Tasmanian region during the 2024-2029 *regulatory control period*, TasNetworks would recover revenue from customers consistent to this *pricing methodology*. More specifically, TasNetworks would be responsible for:

- (1) the allocation of all relevant *AARR* within the Tasmanian region, including any allocation of the *AARR* as agreed between the regulated interconnectors (*TNSPs*) in accordance with 6A.29.3 of the *NER*;
- (2) the calculation of *MLEC* and any adjustment to the *MLEC* in accordance with the *NER* payable by *CNSPs* in interconnected regions; and

¹¹ *NER*, Clause 6A.24.1(d1)

¹² *NER*, Clause 6A.29.2

¹³ *NER*, Clause 6A.29A.1

¹⁴ *NER*, Clause 6A.29.1

- (3) the allocation and billing of MLEC and any adjustments to the MLEC in accordance with the NER, payable or receivable to or from CNSPs in interconnected regions to each TNSP with the Tasmanian region¹⁵.

Should there be multiple *TNSPs* in Tasmania, and TasNetworks is appointed as the *CNSP*, *TNSPs* within the Tasmanian region would be required to advise TasNetworks annually of the *AARR* for its transmission system assets which are used to provide *prescribed transmission services* within the Tasmanian region. They are also required to provide any other information reasonably required by TasNetworks to ensure the proper calculation of *prescribed transmission service* prices in Tasmania¹⁶.

4.1.3 Inter-regional transmission charging

TasNetworks is currently the only *TNSP* in the Tasmanian region, which means that TasNetworks will calculate, bill and arrange for payments of *MLEC*¹⁷. TasNetworks will also calculate adjustments to the *MLEC*¹⁸ in accordance with clause 6A.23.3 of the *NER*.

At the time of writing this document, Basslink is the only *interconnector* between Tasmania and the rest of the *NEM*. It is also a *market network service provider (MNSP)*, therefore there is no requirement for TasNetworks to make allowance for the estimated *inter-regional settlements residue auction amounts*¹⁹.

If, during the 2024-2029 *regulatory control period*, Marinus Link becomes a regulated interconnector and TasNetworks becomes the *CNSP* for the region, TasNetworks will calculate the *AARR* for the Tasmanian region, calculate, bill and arrange for the payment of the *MLEC*²⁰. TasNetworks will publish details of all *MLEC* to apply in the following financial year on its website by 15 March each year²¹.

The inter-regional transmission charging arrangement allows *TNSPs* to levy a *MLEC* on *TNSPs* in interconnected regions. Transmission customers would subsequently pay a share of the costs of the *prescribed transmission services* used to import electricity into their region (Tasmania) from interconnected regions (Victoria).

4.2 Pricing methodology guidelines requirements

The *Pricing Methodology Guidelines* supplement and elaborate on the *Pricing Principles for Prescribed Transmission Services* contained in clause 6A.23 of the *Rules* in so far as they specify or clarify:

- the information that is to accompany a proposed *pricing methodology*;

¹⁵ NER, Clause 6A.29A.4. Billing the modified load export charge

¹⁶ NER, Clause 6A.29.1(e)

¹⁷ NER, Clause 6A.29A and AER Pricing methodology guidelines, Section 2.6

¹⁸ NER, Clause 6A.29A.3

¹⁹ NER, Clause 6A.23.3(b)(1)

²⁰ NER, Clauses 6A.29.1, 6A.29A and AER Pricing methodology guidelines, Section 2.6

²¹ NER, Clause 6A.24.2(b)

- permitted pricing structures for the recovery of the locational component of *prescribed TUOS services*;
- permitted postage-stamp pricing structures for the recovery of the adjusted non-locational component of *prescribed TUOS services* and *prescribed common transmission services*;
- the types of *transmission system assets* that are directly attributable to each *category of prescribed transmission services*;
- the permitted methodologies for determining the *system strength unit price* component of the *system strength charge*;
- principles for determining forecast *annual system strength revenue* and estimated actual *annual system strength revenue*; and
- the parts of a proposed *pricing methodology*, or the information accompanying it that will not be publicly disclosed without the consent of the *TNSP*.

All key elements of TasNetworks' *pricing methodology* are permissible under the *Pricing Methodology Guidelines*. These elements include:

- calculation of the locational component of *prescribed TUOS services* costs using the *modified cost reflective network pricing methodology*;
- the locational *prescribed TUOS services* price being based on *contract agreed maximum demand*;
- the postage-stamp basis of pricing structures for the non-locational component of *prescribed TUOS services* and *prescribed common transmission services* being based on *contract agreed maximum demand* or historical energy;
- the methodology for setting the *system strength unit price* based on long run average costs, covering a 10 year period, at each *system strength node* and the basis for applying an annual indexation to the *system strength unit price*;
- the methodology for forecasting or estimating *annual system strength revenues*;
- the methodology for implementation of priority ordering (being the priority ordering approach under clause 6A.23.2(d) of the *Rules*);
- a description of how asset costs which may be attributable to both *prescribed entry services* and *prescribed exit services* will be allocated at a *connection point*;
- a description of billing arrangements under clause 6A.27 of the *Rules*;
- a description of prudential requirements as outlined in clause 6A.28 of the *Rules*;
- the inclusion of hypothetical worked examples;
- a description of any differences between the pricing methodology applied during the current *regulatory control period* and that proposed for the next *regulatory control period*; and

- a description of how TasNetworks intends to monitor and develop records of its compliance with its approved *pricing methodology*, the *Pricing Principles for Prescribed Transmission Services* (clause 6A.23 of the *Rules*) and part J of the *Rules* in general.

5 TasNetworks' pricing methodology

5.1 Background

This *pricing methodology* incorporates new Rule requirements to:

- include pricing arrangements for system strength, specifically:
 - a methodology for determining the *system strength unit price* component of the *system strength charge*; and
 - a methodology for determining forecast *annual system strength revenue* and estimated *actual annual system strength revenue*;
- provide for the non-locational component of prescribed TUOS to be adjusted for *NTP function fees*;
- outline changes to our pricing requirements in the event that TasNetworks becomes a CNSP in the next *regulatory control period*;
- describe arrangements for energy storage systems (refer section 2.1.4); and
- establish arrangements for recovery of AEMO's participant fees.

The *pricing methodology* ensures that efficient network charges are passed through to customers and energy consumers and that costs are equitably shared. The *pricing methodology* allocates TasNetworks' regulated transmission revenue between customers through setting transmission prices at each connection point throughout Tasmania.

5.2 Single transmission network service provider

At the time of writing, TasNetworks is the sole provider of *prescribed transmission services* within Tasmania and is responsible for the allocation of the AARR within Tasmania, in accordance with clause 6A.29.2 of the *Rules*.

However, should TasNetworks be appointed as a CNSP during the 2024-2029 *regulatory control period*, TasNetworks will undertake additional steps as outlined in sections 4.1.2 and 4.1.3, and further detailed in Appendix F: Inter-regional transmission charging.

In the event that *prescribed transmission services* within Tasmania are provided by more than one *TNSP* and TasNetworks is the CNSP, TasNetworks will allocate the calculated *MLEC* amounts (refer to Appendix F: Inter-regional transmission charging for an example) to each *TNSP* within Tasmania in accordance with clause 6A.29A.5 of the *Rules*.

5.3 Aggregate annual revenue requirement

The revenue that a *TNSP* may earn in any *regulatory year* of a *regulatory control period* from the provision of *prescribed transmission services* is known as the *maximum allowed revenue*.²²

²² Clause 6A.3.1 of the *Rules*.

The AARR is calculated in accordance with clause 6A.22.1 of the *Rules* as:

“the *maximum allowed revenue* referred to in clause 6A.3.1 adjusted:

- (1) in accordance with clause 6A.3.2;
- (2) by subtracting the operating and maintenance costs expected to be incurred in the provision of *prescribed common transmission services* and expected *system strength service payments*; and
- (3) by any allocation as agreed between *Transmission Network Service Providers* in accordance with clause 6A.29.3.”

The adjustments referred in (1) above could relate to a number of factors including:

- reopening of the *revenue determination* for capital expenditure (not being a *pass through event* or a *contingent project*) under clause 6A.7.1 of the *Rules*;
- *network support pass through* under clause 6A.7.2 of the *Rules*;
- cost pass through under clause 6A.7.3 of the *Rules*;
- *service target performance incentive scheme* outcomes under clause 6A.7.4 of the *Rules*;
- *small-scale incentive scheme* outcomes under clause 6A.7.5 of the *Rules*;
- *contingent projects* under clause 6A.8 of the *Rules*; and
- revocation of *revenue determination* for wrong information or error under clause 6A.15 of the *Rules*.

The costs referred in (2) above are derived from budget projections and include:

- network switching and operations;
- administration and management of the business;
- network planning and development; and
- general overheads.

There are no allocations referred to in (3) as TasNetworks is the sole provider of *prescribed transmission services* within Tasmania (see section 5.2).

If TasNetworks becomes the CNSP for the Tasmanian region over the regulatory control period, TasNetworks will become responsible for allocating the AARR for the Tasmanian region under Clause 6A.29.1(a). Each TNSP in the Tasmanian region will be required to calculate its own AARR and advise TasNetworks as required by Clause 6A.29.1(b) and 6A.29.1(e) (see Appendix F).

5.4 Categories of transmission services

TasNetworks' AARR is recovered from transmission charges for the following *categories of prescribed transmission services*:

- *prescribed entry services*, which are *entry services* that are *prescribed transmission services* by virtue of the operation of clause 11.6.11 of the *Rules*;
- *prescribed exit services*, which are *exit services* that are *prescribed transmission services* by virtue of the operation of clause 11.6.11 of the *Rules* and *exit services* provided to *Distribution Network Service Providers*;
- *prescribed common transmission services* (including *system strength transmission services*, as described in section 3). *Prescribed common transmission services* are *system strength transmission services* and *prescribed transmission services* that provide equivalent benefits to:
 - (i) all *Transmission Customers* who have a *connection point* with the relevant *transmission network* without any differentiation based on their location within the *transmission system*; and
 - (ii) *Transmission Network Service Providers* in *interconnected regions*, without any differentiation based on the location of their direct or indirect *connection* or *interconnection* with the relevant *transmission system*.
- *prescribed transmission use of system (TUOS) services*, which are *prescribed transmission services* that are not *prescribed common transmission services*, *prescribed entry services* or *prescribed exit services*, and that provide specific benefits to:
 - (i) *Transmission Customers* who have a *connection point* with the relevant *transmission network*, based on the location of that *connection point* within the *transmission system*; and
 - (ii) *Transmission Network Service Providers* who have a direct or indirect *connection* or an *interconnection* with the relevant *transmission network*, based on the location of that *connection* or *interconnection* within the relevant *transmission system*.

5.5 The pricing process

The determination of *prescribed transmission service* prices involves five steps:

- (a) allocation of the costs of *transmission system* assets to the *categories of prescribed transmission service*, to the extent to which assets are directly attributable to the provision of a *category of prescribed transmission services* (section 5.5.1);
- (b) calculation of the *attributable cost shares* (section 5.5.2);

- (c) calculation of the Annual Service Revenue Requirement (ASRR) by the allocation of the AARR to each category of prescribed transmission services in accordance with the attributable cost share for that category of prescribed transmission services (section 5.5.3);
- (d) allocation of the ASRR for *prescribed entry services*, *prescribed exit services* and *prescribed TUOS services* to each *transmission network connection point* in accordance with the principles set out in clause 6A.23.3 of the *Rules* (section 5.5.4); and
- (e) calculation of prices for each *category of prescribed transmission service* (section 5.5.5).

Each step is described in further detail below.

5.5.1 Cost allocation

The **first step** in calculating *prescribed transmission service* prices is to allocate the costs of transmission system assets to the *categories of prescribed transmission services* in section 5.4 above, to the extent to which assets are directly attributable to the provision of a *category of prescribed transmission services*.

The delineation between the assets that provide *prescribed entry services*, *prescribed exit services*, *prescribed TUOS services* and *prescribed common transmission services* is set out in section 2.4 of the *Pricing Methodology Guidelines*.

TasNetworks' cost allocation process assigns the optimised replacement cost (ORC)²³ of all assets providing *prescribed transmission services* to individual network pricing branches. Each network pricing branch is then defined as common, connection (entry or exit) or shared network. The pricing branches are used to determine the costs of the *transmission system* assets directly attributable to each *category of prescribed transmission services*, as required under chapter 6A of the *Rules*. This cost allocation process is explained in more detail in Appendix B.

5.5.1.1 Allocation of assets providing shared connection services

In the case of a shared *connection* asset (such as a *transformer*) serving multiple *transmission connection points*, which may provide both *prescribed entry services* and *prescribed exit services*, the cost of the shared *connection* asset will be allocated to the appropriate *category or categories of prescribed transmission services* based on a negotiated agreement between the parties involved.

In the absence of any such agreement, any such assets will be attributed on the basis of *contract agreed maximum demand* and the installed *generator* capacity of each *Transmission Network User*.

²³ Consistent with clause 6A.22.3(b) of the *Rules*.

5.5.2 Calculation of the attributable cost share for each category of service

The **second step** in calculating *prescribed transmission service* prices is the calculation of the *attributable cost shares*. The *attributable cost share* for each *category of prescribed transmission services* is calculated in accordance with clause 6A.22.3 of the *Rules* as the ratio of:

- (a) the costs of the *transmission system* assets directly attributable to the provision of that *category of prescribed transmission services*; to
- (b) the total costs of all the *Transmission Network Service Provider's transmission system* and any other *transmission system* assets directly attributable to the provision of *prescribed transmission services*,

where these amounts are determined as detailed in section 5.5.1 above.

For example, if the ORCs of *prescribed transmission services* assets have been allocated to the applicable *categories of prescribed transmission services* as shown in Table 1 then the *attributable costs shares* are calculated as shown in the hypothetical example below:

Table 1 Hypothetical costs allocated to categories of prescribed transmission services

Category	ORC (\$)
Exit services	100,000,000
Entry services	50,000,000
TUOS services	650,000,000
Common services	200,000,000
Total	1,000,000,000

$$\begin{aligned}
 \text{Attributable cost share}_{\text{EXIT}} &= \text{ORC}_{\text{EXIT}} / \text{ORC}_{\text{TOTAL}} \\
 &= \$100,000,000 / \$1,000,000,000 \\
 &= 0.10
 \end{aligned}$$

with the *attributable cost shares* of the other *categories of prescribed transmission services* calculated in the same manner, as shown in Table 2.

Table 2 Hypothetical attributable cost shares

Category	ORC (\$)	Attributable cost share
Exit services	100,000,000	0.10
Entry services	50,000,000	0.05
TUOS services	650,000,000	0.65
Common services	200,000,000	0.20
Total	1,000,000,000	1.00

5.5.3 Calculation of the annual service revenue requirement (ASRR)

The **third step** in calculating *prescribed transmission service* prices is to allocate the *AARR* to each *category of prescribed transmission services* in accordance with the *attributable cost share* for that *category of prescribed transmission services*.

This allocation results in the *ASRR* for each *category of prescribed transmission services*.

Assuming an *AARR* of \$150,000,000 and applying the *attributable cost shares* determined above, the *ASRR* for each *category of prescribed transmission services* is calculated as:

$$\begin{aligned} ASRR_{\text{EXIT}} &= AARR \times \text{Attributable cost share}_{\text{EXIT}} \\ &= \$150,000,000 \times 0.10 \\ &= \$15,000,000 \end{aligned}$$

with the *ASRRs* of the other *categories of prescribed transmission services* calculated in the same manner.

Table 3 Hypothetical annual service revenue requirements

Category	Attributable cost share	Annual Service Revenue Requirement (\$)
Exit services	0.10	15,000,000
Entry services	0.05	7,500,000
TUOS services	0.65	97,500,000
Common services	0.20	30,000,000
Total	1.00	150,000,000

5.5.4 Allocation of the ASRR to transmission network connection points

The **fourth step** in calculating *prescribed transmission service* prices is to allocate the *ASRR* for *prescribed entry services*, *prescribed exit services* and *prescribed TUOS services* to each *transmission network connection point* in accordance with the principles of clause 6A.23.3 of the *Rules*.

5.5.4.1 Prescribed entry services

The whole of the *ASRR* for *prescribed entry services* is allocated to each *transmission network connection point* in accordance with the *attributable connection point cost share* for *prescribed entry services* that are provided by the *TNSP* at that *connection point*.

The *attributable connection point cost share* for *prescribed entry services* is the ratio of the costs of the *transmission system* assets directly attributable to the provision of *prescribed entry services* at that *transmission network connection point* to the total costs of all the *TNSP's* *transmission system* assets directly attributable to the provision of *prescribed entry services*.

For example, if two *Generators*, Gen A1 and Gen A2, receive *prescribed entry services* and the cost allocation process has allocated the *ORCs* of assets directly attributable to *prescribed entry services* to them as shown in Table 4.

Table 4 Hypothetical prescribed entry services ORCs

Entry service (connection point)	ORC (\$)
Gen A1	10,000,000
Gen A2	15,000,000
Gen A3	20,000,000
Gen A4	5,000,000
Total ORC of prescribed entry assets	50,000,000

$$\begin{aligned}
 \text{Attributable connection point cost share}_{\text{GEN A1}} &= \text{ORC}_{\text{GEN A1}} / \text{ORC}_{\text{ENTRY}} \\
 &= \$10,000,000 / \$50,000,000 \\
 &= 0.20
 \end{aligned}$$

with the *attributable connection point cost share* of the other *Generator* being calculated in the same manner, shown in Table 5.

Table 5 Hypothetical attributable connection point cost shares

Entry service (connection point)	ORC (\$)	Attributable connection point cost share
Gen A1	10,000,000	0.20
Gen A2	15,000,000	0.30
Gen A3	20,000,000	0.40
Gen A4	5,000,000	0.10
Total ORC of prescribed entry assets	50,000,000	1.00

The *ASRR* allocated to the Gen A1 *transmission network connection point* is calculated as follows:

$$\begin{aligned}
 \text{ASRR}_{\text{GEN A1}} &= \text{ASRR}_{\text{ENTRY}} \times \text{Attributable connection point cost share}_{\text{GEN A1}} \\
 &= \$7,500,000 \times 0.20 \\
 &= \$1,500,000
 \end{aligned}$$

with the *ASRR* for the Gen A2 *transmission network connection point* being calculated in the same manner.

Table 6 Hypothetical connection point ASRRs (entry)

Entry service (connection point)	ORC (\$)	Attributable connection point cost share	Connection point ASRR (\$)
Gen A1	10,000,000	0.20	1,500,000
Gen A2	15,000,000	0.30	2,250,000
Gen A3	20,000,000	0.40	3,000,000
Gen A4	5,000,000	0.10	750,000
Total ORC of prescribed entry assets	50,000,000	1.00	7,500,000

5.5.4.2 Prescribed exit services

The whole of the ASRR for *prescribed exit services* is allocated to each *transmission network connection point* in accordance with the *attributable connection point cost share* for *prescribed exit services* that are provided by the TNSP at that *connection point*.

The *attributable connection point cost share* for *prescribed exit services* is the ratio of the costs of the *transmission system* assets directly attributable to the provision of *prescribed exit services* at that *transmission network connection point* to the total costs of all the *transmission system* assets directly attributable to the provision of *prescribed exit services*.

The ASRRs of the *prescribed exit services connection points* are calculated in the same manner as for the *prescribed entry services connection points*.

Table 7 Hypothetical connection point ASRRs (exit)

Exit service (connection point)	ORC (\$)	Attributable connection point cost share	Connection point ASRR (\$)
Load A1	40,000,000	0.40	6,000,000
Load A2	8,000,000	0.08	1,200,000
Load B1	35,000,000	0.35	5,250,000
Load B2	17,000,000	0.17	2,550,000
Total	100,000,000	1.00	15,000,000

5.5.4.3 Prescribed transmission use of system services

The *prescribed TUOS services ASRR* is recovered from:

- *prescribed TUOS services* (locational component); and
- *prescribed TUOS services* (adjusted non-locational component).

Clause 6A.23.3(a)(1) requires that 50 per cent of the ASRR for *prescribed TUOS services* is to be allocated between a *pre-adjusted locational component* and a *pre-adjusted non-locational component*, unless different allocation shares can be justified. TasNetworks will use the prescribed 50 per cent shares, in line with TasNetworks' previous practices.²⁴

Clause 6A.23.3(b) of the *Rules* requires that:

- (b) Subject to paragraph (d), the *pre-adjusted locational component* is to be adjusted by:
- (1) subtracting any amount estimated as proceeds from *auctions* or any portion of *settlements residue* allocated to the *directional interconnector* which is not the subject of a *SRD agreement* estimated to be receivable by the *Transmission Network Service Provider* from the *connection points* for each

²⁴ These 50 per cent shares are allocated to the locational and non-locational components prior to subsequent adjustments allowed by the *Rules* (see clauses 6A.23.3(b) and 6A.23.3(e) of the *Rules*). Therefore, the actual share of the ASRR for *prescribed TUOS services* recovered from the locational and non-locational components will be different to the 50 per cent share initially allocated to each component.

relevant *directional interconnector* as referred to in clause 3.18.4, with that amount including an adjustment calculated in accordance with paragraph (f); and

- (2) adding or subtracting the amount estimated by the *Co-ordinating Network Service Provider* for the *modified load export charge* receivable by or payable to the *Transmission Network Service Provider* under clause 6A.29A.5, with that amount including an adjustment calculated in accordance with paragraph (f),

(the *adjusted locational component*).

Basslink is the only *interconnector* between Tasmania and the rest of the *NEM*. As Basslink is a *market network service provider (MNSP)*, there is no requirement for TasNetworks to make allowance for the estimated *inter-regional settlements residue auction amounts* as outlined in clause 6A.23.3(b)(1) of the *Rules*.

TasNetworks will also calculate the *modified load export charge* referred to in clause 6A.23.3(b)(1) of the *Rules*. For more details on *inter-regional transmission* charging refer to Appendix F of this *pricing methodology*.

The *adjusted locational component* is allocated between *transmission network connection points* of *Transmission Customers* on the basis of the estimated proportionate use of the relevant *transmission system* assets, excluding, to avoid doubt, assets which constitute an *identified user shared asset* or *designated network asset*, by each customer using the *modified CRNP methodology* (clause 6A.23.3(c)). TasNetworks has employed the *modified CRNP methodology* previously because of the highly radialised nature of the *transmission system* in Tasmania and proposes to continue to apply the *modified CRNP methodology* as described in section 5.5.4.4.

The *CRNP methodology* allocates a proportion of shared network costs to individual customer *connection points*. TasNetworks applies the *modified CRNP methodology* using the TPRICE *cost reflective network pricing* software approved by the *AER* for use by *TNSPs* in the *NEM*.

Appendix C describes the *CRNP methodology* in more detail.

As required under clause 6A.23.3(e) of the *Rules*, the *pre-adjusted non-locational component* is to be adjusted by:

- (1) subtracting the absolute value of the amount (if any) referred to in clause 6A.23.3(d);
- (2) adding or subtracting any amount for *settlements residue* (not being any *auction* amount referred to in subparagraph (b)(1)) or *settlements residue* that accrue on a *designated network asset* due to *boundary point loss factors*, but otherwise including any amount of *settlements residue* due to *intra-regional loss factors*) estimated to be receivable by or payable to the *Transmission Network Service Provider* in accordance with clause 3.6.5(a)(3);
- (3) adding or subtracting any adjustment arising as a result of the application of clauses 6A.23.4(c) and (d);

- (4) adding or subtracting any amount arising as a result of the application of prudent discounts (if any) under clauses 6A.26.1(d) to (g);
- (5) adding or subtracting any *over-recovery amount* or *under-recovery amount*, with that amount including an adjustment calculated in accordance with paragraph (f);
- (6) adding the amount of *NTP function* fees advised in accordance with clause 2.11.3(ba)²⁵; and
- (7) adding the amount of the *Participant fees* (excluding *NTP function fees*) advised by AEMO to TasNetworks for that relevant financial year in accordance with clause 11.153.2(b)²⁶.

(the *adjusted non-locational component*).

5.5.4.4 Modified cost reflective network pricing methodology

The modification of the standard *CRNP* process employed by TasNetworks is to discount the charges to be recovered from radial *transmission lines* by the utilisation of those lines. For example, if the *CRNP methodology* suggests that TasNetworks should recover \$1 million from a particular radial line that has a utilisation factor of 60 per cent, then only \$0.6 million is recovered from connection points relating to this line through the locational component of the *prescribed TUOS services ASRR*. The modification applies to radial lines only and is not applied to those assets that are part of the meshed *transmission network*.

The reason for applying this modification is that it means that existing customers are not penalised for the low utilisation of such assets and it provides potential customers with a financial incentive to locate where the utilisation rate is low, thereby enhancing overall utilisation of the *transmission system* and potentially deferring augmentation.

Consistent with section 2.2(b) of the *Pricing Methodology Guidelines*, the output of the TPRICE software is a “lump sum dollar amount to be recovered at each *transmission connection point*”.²⁷ Using the *modified CRNP methodology* will mean that the aggregate value of these lump sum dollar amounts is less than the 50 per cent allocation of the *ASRR* for *prescribed TUOS services* that was to be allocated through the locational component. Any part of the *ASRR* for the locational component that is not allocated due to application of the *modified CRNP* is added to the non-locational component. In the example above, \$0.4 million would not be allocated to *connection points* by virtue of the *modified CRNP*, so this amount is added to (and recovered via) the non-locational component.

5.5.5 Transmission prices and charges

The **fifth step** in the determination of *prescribed transmission prices* is the development of separate prices for each *category of prescribed transmission services*, being:

- *prescribed entry services*;

²⁵ NER, Clause 6A.23.3(e)(6)

²⁶ NER, Clause 11.153.3(a)

²⁷ AER, Final, Electricity transmission network service providers, Pricing methodology guidelines, version 3, 25 August 2022, p.10.

- *prescribed exit services*;
- *prescribed common transmission services*;
- *prescribed TUOS services* – locational component; and
- *prescribed TUOS services* – the adjusted non-locational component.

5.5.5.1 *Prescribed entry and exit service*

Prescribed entry services and *prescribed exit services* prices are calculated to recover the *prescribed entry* and *prescribed exit services ASRRs* from the *Network Users* who are served by the relevant *connection* assets.

The *prescribed entry services ASRR* is recovered as a fixed annual charge for each relevant *connection point*. The process to determine the *ASRR* for *prescribed entry services* for each individual *connection point* was determined in section 5.5.4.1. This amount will be recovered by a fixed dollar amount per month.

Similarly, the *prescribed exit services ASRR* is recovered as a fixed annual charge for each relevant *connection point*. The process to determine the *ASRR* for *prescribed exit services* for each individual *connection point* was determined in section 5.5.4.2. This amount will be recovered by a fixed dollar amount per month.

5.5.5.2 *Prescribed TUOS services: locational component prices and charges*

Consistent with the provisions of section 2.2(c)(1) of the *Pricing Methodology Guidelines*, locational prices will be determined on the basis of *contract agreed maximum demand*.

The *prescribed TUOS services* locational *ASRR* described in section 5.5.4.3 is priced on a *contract agreed maximum demand* basis (\$/MW/day), where the *contract agreed maximum demand* is specified in, and re-negotiated in accordance with, customer connection agreements.

The *modified CRNP methodology* outlined in schedule S6A.3 of the *Rules* and detailed in this *pricing methodology* describes the process for cost allocation for the locational component of *prescribed TUOS services*, which results in a lump sum dollar amount to be recovered at each *connection point*.

This lump sum dollar amount for each *connection point* is divided by the product of the number of *days* in the forthcoming *financial year* and the *contract agreed maximum demand* (prevailing at the time transmission prices are published) to calculate the locational price for each *connection point*²⁸ and is expressed as \$/MW/day.

As provided for under clause 6A.23.4(b)(2) of the *Rules*, *prescribed TUOS services* locational prices must not change by more than 2 percentage points per annum at *connection points* relative to the load weighted average *prescribed TUOS services* locational price for the *region*. The balance of any revenue shortfall or *over-recovery amount* resulting from these price caps is recovered or offset as appropriate by adjusting the *prescribed TUOS services* non-locational prices and charges.

²⁸ The *connection point* for the purposes of determining the *prescribed TUOS* prices and *prescribed TUOS* charges will be the agreed point (or points) of supply between TasNetworks and the *transmission network user*.

As further provided for under clause 6A.23.4(b)(3) of the *Rules*, prices for recovering the *prescribed TUOS services – adjusted locational component* “are not subject to the limitation in subparagraph (2):

- (i) to the extent that the change in prices relate to the adjusted *modified load export charge* as referred to in clause 6A.23.3(b)(2); or
- (ii) if, since the commencement of the previous *regulatory year*:
 - (A) the *load* at the *connection point* has materially altered;
 - (B) in connection with that alteration, the *Transmission Customer* requested a renegotiation of its *connection agreement* with the *Transmission Network Service Provider*; and
 - (C) the *AER* approved the change.”

This provision sets the *prescribed TUOS services* locational price at a *connection point* with a material change in *load* on the same basis as a new *connection point*.

In the event that a *Transmission Customer* requests a material change in *contract agreed maximum demand* at an existing *connection point*, TasNetworks may seek approval from the *AER* to set the *prescribed TUOS services* locational price as intended by clause 6A.23.4(b)(3) of the *Rules*.

Prescribed TUOS services locational charges are determined for each *connection point* providing *prescribed TUOS services* by multiplying the *prescribed TUOS services* locational price by the *contract agreed maximum demand* (prevailing during the billing period²⁹ concerned) for that *connection point*, determined in accordance with the customer's *connection agreement*, and multiplying this amount by the number of *days* in the billing period.

Any *over-recovery amount* or *under-recovery amount* arising from variances between forecast *contract agreed maximum demands* and the *contract agreed maximum demands* used for calculating *prescribed TUOS services* locational charges will be addressed by way of an *under-recovery amount* or an *over-recovery amount* adjustment when calculating prices in future *financial years*.

Changes to contract agreed maximum demand

On the basis that customers' *contract agreed maximum demands* are used to determine prices and to calculate charges, any changes to a customer's *contract agreed maximum demand* will have repercussions on the recovery of the *AARR*. Further, a core tenet of pricing for *prescribed transmission services* is that a customer's current behaviour should only affect their locational charge, with all other charges effectively being fixed (or sunk costs). Therefore, it is clear that customers should not be able to change their *contract agreed maximum demand* simply for the sake of reducing their charges.

If customers were permitted to reduce their *contract agreed maximum demand* during a *financial year* on a temporary basis, it would provide an incentive for customers with seasonal demands to alter their *contract agreed maximum demand* to match their demand. This would

²⁹ For the purposes of this *pricing methodology*, references to a billing period refer to a calendar month.

introduce an unnecessary element of complexity into the pricing calculations, as well as customer and asset management.

While the implications for pricing would be addressed through the existing under and over-recovery process, it would not overcome the principle outlined above that a customer's current behaviour should only affect their locational charge.

There would also be a further complication for sites providing *connection services* to more than one customer. In such situations, the cost of assets providing services to more than one customer is (typically) allocated according to the ratio of each customer's *contract agreed maximum demand*. In the situation where one customer reduces their *contract agreed maximum demand*, the other customer(s) at that site would face increased connection charges.

TasNetworks' connection agreement will specify the process required to adjust a customer's *contract agreed maximum demand*. Any requests to reduce a customer's *contract agreed maximum demand* on a temporary basis (for example, for seasonal demands) will not result in any reduction during the prevailing *financial year* of any charges calculated using *contract agreed maximum demand*. However, any increases in *contract agreed maximum demand* or any decreases that are of a permanent nature will be applied immediately to the calculation of relevant charges.

5.5.5.3 Prescribed TUOS services: non-locational component prices and charges

Prices for recovery of the adjusted non-locational component of *prescribed TUOS services* are set on a *postage-stamp basis* in accordance with clause 6A.23.4(e) of the *Rules*.

Consistent with the provisions of section 2.3(c)(1) of the *Pricing Methodology Guidelines* prices on a *postage-stamp basis* are determined on the basis of *contract agreed maximum demand* and historical *energy* offtake and calculated annually as follows.

Each *financial year* TasNetworks will determine the following two prices to apply at every *connection point*:

- an *energy*-based price that is a price per unit of historical metered *energy* or current metered *energy* at a *connection point* expressed as \$/MWh; and
- a *contract agreed maximum demand* price that is a price per unit of *contract agreed maximum demand* at a *connection point* expressed as \$/MW/month.

Either the *energy*-based price or the *contract agreed maximum demand* price will apply at a *connection point* providing *prescribed TUOS services* except for those *connection points* where a *Transmission Customer* has negotiated reduced charges for the adjusted non-locational component of *prescribed TUOS services* in accordance with clause 6A.26.1 of the *Rules* (prudent discounts).

The *energy*-based price and the *contract agreed maximum demand* price is determined so that:

- a *Transmission Customer* with a *load factor* in relation to its *connection point* equal to the median *load factor* for *connection points* with *Transmission Customers* connected to the *transmission network* in the *region* or *regions* is indifferent between the use of the *energy*-based price and the *contract agreed maximum demand* price; and

- the total amount to be recovered by the adjusted non-locational component of *prescribed TUOS services* does not exceed the *ASRR* for this *category of prescribed transmission service*.

The *energy-based price* or the *contract agreed maximum demand price* that applies for the adjusted non-locational component of *prescribed TUOS services* at a *connection point* will be the one which results in the lower estimated charge for that *prescribed transmission service*.

When applying the *energy-based price*, the *prescribed TUOS services* non-locational component charge for a billing period is calculated for each *connection point* by:

- multiplying the *energy-based price* by the metered *energy* offtake at that *connection point* in the corresponding billing period two years earlier (that is, historical metered *energy* offtake); or
- multiplying the *energy-based price* by the metered *energy* offtake at that *connection point* in the same billing period (current metered *energy* offtake) if the historical metered *energy* offtake is unavailable; or
- multiplying the *energy-based price* by the current metered *energy* offtake if the historical metered *energy* offtake is significantly different to the current metered *energy* offtake.

When applying the *contract agreed maximum demand price*, the *prescribed TUOS services* non-locational component charge for a billing period will be calculated for each *connection point* by multiplying the *contract agreed maximum demand price* by the *contract agreed maximum demand* for the *connection point* (prevailing during the billing period concerned).

Forecast *prescribed TUOS services* non-locational charges will be calculated using the *contract agreed maximum demand* prevailing at the time prices are determined, while the actual *contract agreed maximum demand* based charges will be calculated using the *contract agreed maximum demand* prevailing during the billing period concerned.

Any *over-recovery amount* or *under-recovery amount* arising from variances between forecast *contract agreed maximum demands* and the *contract agreed maximum demands* used for calculating charges will be addressed by way of an *under-recovery amount* or *over-recovery amount* adjustment when calculating prices in future *financial years*.

5.5.5.4 *Prescribed common service prices and charges*

Prices for *prescribed common transmission services* are set on a *postage-stamp basis* in accordance with clause 6A.23.4(f) of the *Rules*. Prices for *system strength transmission services* are determined as per the arrangements outlined in section 5.6, which is to meet the requirements set out in clause 6A.23.4(h) of the *Rules*.

Consistent with the provisions of section 2.3(c)(1) of the *Pricing Methodology Guidelines* postage-stamped prices will be determined on the basis of *contract agreed maximum demand* or historical *energy* offtake and calculated in a manner identical to that described for *prescribed TUOS services* non-locational charges in the previous section.

In accordance with clause 6A.23.3(h) of the *Rules* the operating and maintenance costs expected to be incurred in the provision of *prescribed common transmission services* and expected *system strength service payments*, which are deducted from the *maximum allowed*

revenue to form the AARR, are added to the ASRR for *prescribed common transmission services* and recovered through *prescribed common transmission service* prices and charges.

In accordance with clause 6A.23.3(h1), in addition to the adjustment under paragraph (h), the ASRR for *prescribed common transmission services* must be adjusted by subtracting the forecast *annual system strength revenue* for the *regulatory year* and any adjustment for under or over recovery from previous years, calculated in accordance with clause 6A.23.3A(b). These adjustments enable:

- revenue from *system strength charges* to be recovered from *System Strength Transmission Service Users* in accordance with section 5.6 of this *pricing methodology*;
- any residual annual costs in providing *system strength services* that are not forecast to be recovered from *system strength charges* to be recovered from all *Transmission Customers* through *common service charges*; and
- any under- or over-recovery in relation to *annual system strength revenue* for years t-1 and t-2 to be corrected by adjusting the *annual service revenue requirement* for *prescribed common transmission services* for year t.

To give effect to clauses 6A.23.3(h1) and 6A.23.3A(a)(1) and (2), we will forecast the *annual system strength revenue* for year t and the estimate of the actual *annual system strength revenue* for year t-1. While our forecasting methodology will change in light of new information and experience, it will comply with the following principles specified in paragraphs 2.1(k)(7), 2.1(k)(8) and 2.8 of the AER's *pricing methodology guidelines*:

- (1) the methodologies will be reasonable and appropriate for their purpose;
- (2) the cost of implementing the methodologies will be proportionate to the expected level of materiality of the impact of any inaccuracy in estimates of forecasts;
- (3) the methodologies will utilise relevant existing information to the extent possible, including information from *connection agreements* and, where relevant, applications to connect;
- (4) the methodologies will be consistent with any relevant parts of the *system strength requirements methodology* and *system strength impact assessment guidelines*;
- (5) the methodologies will be consistent with other relevant parts of the *pricing methodology* and our approach to other relevant forecasts or estimates; and
- (6) estimated actual *annual system strength revenue* will be based on actual data for part of the *regulatory year* where actual data is available and updated forecasts for the remainder of the *regulatory year*.

For the purpose of this *pricing methodology*, which covers the second *system strength charging period*, it is noted that:

- there is limited historical data that could inform our forecast revenue from *system strength charges*; and

- there will be limited information available regarding the likelihood that connecting applicants will elect to pay the *system strength charge* in relation to the proposed *connection* or alteration.

Given the limited historical data, our methodology for forecasting the annual revenue from *system strength charges* will have regard to the following information:

- actual contracts for the provision of *system strength services* for the relevant year;
- forecast new connections for the relevant year having regard to known connection enquiries and connection applications;
- forecast of the new connections that will elect to pay the *system strength charge*, having regard to the facility seeking or likely to seek connection and an estimate of the costs of self-remediation; and
- the estimated applicable *system strength unit prices*; system strength locational factors; and *system strength quantity* applicable to each actual and forecast contract for the provision of *system strength services*.

Our forecasting method will be reviewed and updated as historical data becomes available. Over time, an increasing proportion of our *system strength charges* will be obtained from existing connections, rather than new connections. As a result, the accuracy of our revenue forecasts will tend to improve in future regulatory periods.

5.6 System Strength Charges

The charging arrangements described in this section satisfy the requirements of clause 6A.23.5 of the *Rules* and paragraph 2.7 of the AER's *pricing methodology guidelines*.

5.6.1 Overview of the charging arrangements

The *System Strength Transmission Service User* for a *system strength connection point* must pay an *annual system strength charge* for the *system strength connection point* calculated in accordance with this section 6.12. The *annual system strength charge* is payable in equal monthly instalments. *System strength charges* come into effect from 1 July 2023.

If the obligation to pay the *system strength charge* in relation to a *system strength connection point* commences part way through a *regulatory year*, the *annual system strength charge* will be calculated on a pro rata basis and charged for the remaining months of the *regulatory year*.

The *annual system strength charge* for a *system strength connection point* for a *regulatory year* will be calculated in accordance with the following formula:

$$SSC = SSUP \times SSL \times SSQ$$

Where:

SSC is the *annual system strength charge* for the *regulatory year* (in \$).

SSUP is the *system strength unit price* for the *system strength node*. SSUP will be the same for each *regulatory year* in a *system strength charging period*, except to the extent the *pricing methodology guidelines* permit indexation, in accordance with clause 6A.23.5(f).

SSL is the *system strength locational factor* applicable to the *system strength connection point*, calculated in accordance with the *system strength impact assessment guidelines*. SSL will be the same for each *regulatory year* in a *system strength charging period*.

SSQ is the *system strength quantity* applicable to the relevant *system strength connection point* (in MVA). It should be noted that:

- SSQ is the product of (1) the short circuit ratio and (2) the rated active power, calculated in accordance with clause 6A.23.5(j).
- If a change to the SSQ comes into effect part way through a *regulatory year*, the monthly instalments of the *annual system strength charge* for the remaining months of the *regulatory year* will be calculated using the new *system strength quantity*, in accordance with clause 6A.23.5(k).

The *system strength charging period* commences from the start of the second *regulatory year* in a regulatory control period to the end of the first *regulatory year* in its next regulatory control period.

5.6.2 System Strength Unit Price

A *system strength unit price (SSUP)* will be set for each *system strength node* on the transmission network. In accordance with the *Rules* and the AER's *pricing methodology guidelines*, the methodology determines the SSUP according to the 'forward-looking' long run average cost of providing the system strength capacity at each *system strength node*.

SSUP will be calculated in real terms and indexed annually in accordance with this methodology. Appendix G provides worked examples to illustrate the application of the methodology, which is described below.

The SSUP is a price per MVA that reflects the forecast long run average costs of providing *system strength transmission services* at the relevant *system strength node* calculated as follows:

$$\text{SSUP} = \frac{\text{[the total long run capital and operating costs of providing an efficient quantity of system strength at a system strength node, over a period of t years]}}{\text{[the total system strength hosting capacity provided by that system strength node, over a period of t years]}}$$

Where:

“Long run” means the costs of providing system strength capacity at a *system strength node*, having regard to the actual and forward-looking costs of providing the required capacity at that node. Specifically:

- the long run costs include TasNetworks’ actual costs of providing system strength capacity where the forward-looking costs are higher than our actual costs; and
- the long run costs include the forward-looking costs of providing system strength capacity where these costs are lower than TasNetworks’ actual costs.

Capital and operating costs of providing *system strength transmission services* will include, where relevant:

- the annualised capital costs of providing the required system strength capacity at a *system strength node* in each year for a period of t years;
- the annual operating costs required to operate and maintain network assets employed to provide the required system strength capacity at a *system strength node* in each year for a period of t years; and
- the annual costs of contracts with non-network service providers to provide the required system strength capacity at a *system strength node* in each year for a period of t years.

“total system strength hosting capacity” means the quantity of system strength provided by a *system strength node* to supply an efficient quantity of system strength to *connection points* in each year for a period of t years.

“t years” is 10 years.

Cost allocation

In relation to the process of allocating capital and operating costs to *system strength nodes*, it should be noted that:

- The capital and operating costs of providing system strength capacity may be attributable to more than one *system strength node*. In such cases, the costs of providing that system strength capacity will be allocated to each of the relevant *system strength nodes* on a reasonable basis to reflect the percentage of that capacity used at each of those nodes.
- The capital and operating costs of providing system strength capacity at a *system strength node* may include an allocation from one or more sources of system strength capacity, whether that source is a network investment or a contract with a non-network service provider.
- The capital and operating costs of providing system strength capacity at a *system strength node* will have regard to the National Electricity Amendment (Operational Security Mechanism) Rule 2022.

Compliance

The methodology described above is consistent with clause 2.7(a) of the AER’s *pricing methodology guidelines* which required that the SSUP must:

- (1) be based on a forecast of the long run average costs of *providing system strength transmission services* at the relevant *system strength node*;
- (2) use a period of at least 10 years when forecasting long run costs;
- (3) set a price on a dollars per MVA per year basis;
- (4) set a price that is fixed for the *system strength charging period*; and
- (5) set a price for each *system strength node*.

Indexation

In accordance with clause 2.7(b) of the AER's *pricing methodology guidelines*, the SSUP will be indexed annually by the same inflation series the AER uses to index the maximum allowed revenue under the revenue determination from one year to the next.

5.7 Standby service arrangements

This provision addresses the situation where TasNetworks has agreed to provide *prescribed transmission services* on a standby basis (such as to cover the *outage of onsite generation*).

If TasNetworks agrees to provide a standby service, the customer's *connection agreement* must specify the terms and conditions applying to the provision of that service.

The customer's *connection agreement* would be required to specify the *contract agreed maximum demand* required to be available to the customer under normal operating conditions and a greater demand that may be sought on a standby basis subject to the operational condition of the *transmission network* at the time the standby arrangements are requested. The *transmission network* would be planned and developed to satisfy the (lower) *contract agreed maximum demand* rather than the (higher) standby demand.

If standby services are included in a customer's *connection agreement*, the customer will pay *prescribed exit services charges* (if applicable), *prescribed TUOS services* locational component charges, *prescribed TUOS services* non-locational component charges and *prescribed common transmission services* based on:

- the *contract agreed maximum demand* under normal operating conditions; and
- the standby demand and/or actual *energy* consumption during times that the standby service is actually utilised for *energy* delivery to the customer.

For the avoidance of doubt,

- where a standby service arrangement has been agreed between TasNetworks and the relevant customer, the customer's *connection agreement* must specify (amongst other things) a *contract agreed maximum demand* and the conditions under which an excess demand charge (as detailed in section 5.8) will apply; and
- nothing in section 5.7 obliges TasNetworks to agree to provide a standby service arrangement requested by a customer.

5.8 Excess demand charge

A *contract agreed maximum demand* price can only be applied for the postage stamped prices if the *Transmission Customer's connection agreement* or other enforceable instrument governing the terms of *connection* of the *Transmission Customer*:

- nominates a *contract agreed maximum demand* for the *connection point*; and
- specifies penalties for exceeding the *contract agreed maximum demand*.

If in any month the 30-minute *billing demand*³⁰ at a *connection point* exceeds the *contract agreed maximum demand* for that *connection point* without the prior approval of TasNetworks, then the *Transmission Customer* will be liable to pay an excess active demand charge.

The excess active demand charge will be set at three times the *prescribed TUOS services* locational component price for the relevant *connection point* multiplied by the amount by which the billing demand exceeds the *contract agreed maximum demand*.

For the avoidance of doubt, it should be noted that the excess active demand charge is levied in addition to the *prescribed TUOS services* locational component charge. Monies recovered through the excess active demand charge are treated as revenue from *prescribed transmission services* and therefore included in TasNetworks' *maximum allowed revenue*.

5.9 Setting of prescribed TUOS services locational prices between annual price publications

In the event that TasNetworks is required to set a *prescribed TUOS services* locational price at a new *connection point* or at a *connection point* where the *load* has changed significantly after *prescribed TUOS service* locational prices have been determined and *published*, an interim price, not subject to the side constraints of clause 6A.23.4(b)(2) of the *Rules*, will be determined. This will be calculated using the prevailing pricing models with demands estimated in a manner consistent with section 2.2(f) of the *Pricing Methodology Guidelines*.

A price subject to the side constraints of clause 6A.23.4(b)(2) of the *Rules* will be determined and published at the next annual price determination.

³⁰ Billing demand is the greater of a *Transmission Customer's* 30-minute *maximum demand* and that customer's 30 minute maximum *apparent power* (in MVA) multiplied by their minimum *Rules*-required *power factor*.

6 Billing arrangements

The process of billing for *modified load export charges*, which is regulated under clause 6A.29A.4 of the *Rules*, is outlined in section 6.1.1. The process of billing for other *prescribed transmission services* is outlined in section 6.1.2.

6.1.1 Billing for modified load export charges

As the sole provider of *prescribed transmission services* within Tasmania, TasNetworks will issue a bill on a monthly basis to the *Co-ordinating Network Service Provider* for each *interconnected region* for the *modified load export charge* (including any adjustment made to it in accordance with the *Rules*) payable to it by that *Co-ordinating Network Service Provider*.³¹

Bills for *modified load export charges* will be issued in accordance with the requirements specified in clause 6A.29A.4(b) of the *Rules* unless TasNetworks and the *Co-ordinating Network Service Provider* being billed agree to such terms and conditions for billing as may be considered appropriate.

6.1.2 Billing for prescribed transmission services

Consistent with clause 6A.27.1 of the *Rules*, TasNetworks will calculate the *transmission service charges* payable by *Transmission Network Users* and *system strength charges* payable by *System Strength Transmission Service Users* for each *connection point* in accordance with the *transmission service* prices published under clause 6A.24.2 of the *Rules*.

Where charges are determined for *prescribed transmission services* from metering data, these charges will be based on kW or kWh (or MW or MWh) obtained from the metering data managed by AEMO.

TasNetworks will issue invoices to *Transmission Network Users* for *prescribed transmission services* and to *System Strength Transmission Service Users* for *system strength charges*, which satisfy or exceed the minimum information requirements specified in clause 6A.27.2 of the *Rules* on a monthly basis or as specified in the customer's *connection agreement*.

In addition to the minimum information requirements in clause 6A.27.2(a), a bill for a *connection point* issued directly to a *Distribution Network Service Provider* or *Transmission Network Service Provider* relating to *system strength charges* will separately identify the *system strength charge* by *connection point*.

Consistent with clause 6A.27.3 of the *Rules* a *Transmission Network User* must pay charges for *prescribed transmission services* properly charged to it and billed in accordance with this *pricing methodology* by the date specified on the invoice.

³¹ As at the date of publication, Victoria is the only *interconnected region* and AEMO is the *Co-ordinating Network Service Provider* for that *region*.

6.1.3 Payments between Transmission Network Service Providers

If another *TNSP* is granted a Transmission Licence and is registered as a *Transmission Network Service Provider* by AEMO in the Tasmanian *region*, consistent with clause 6A.27.4 of the *Rules*, one *TNSP* will become the *Co-ordinating Network Service Provider* under clause 6A.29.1 of the *Rules*. The *TNSPs* will pay to each other relevant *TNSP* revenue which is estimated to be collected during the following *financial year* by the first provider as charges for *prescribed transmission services* for the use of *transmission systems* owned by those other *TNSPs*.

Such payments will be determined by the *Co-ordinating Network Service Provider* for the *region*.

Financial transfers payable under clause 6A.27.4 of the *Rules* will be paid in equal monthly instalments or as documented in revenue collection agreements negotiated between the parties.

7 Prudential requirements

7.1 Prudential requirements for prescribed transmission services

Consistent with clause 6A.28.1 of the *Rules*, TasNetworks may require a *Transmission Network User* to establish *prudential requirements* for either or both *connection services* and *transmission use of system services*. These *prudential requirements* may take the form of, but need not be limited to, capital contributions, pre-payments or financial guarantees.

The requirements for such *prudential requirements* will be negotiated between the parties and specified in the applicable *transmission connection agreement*.

7.2 Capital contribution or prepayment for a specific asset

Consistent with clause 6A.28.2 of the *Rules*, where TasNetworks is required to construct or acquire specific assets to provide *prescribed connection services* or *prescribed TUOS services* to a *Transmission Network User*, TasNetworks may require that *Transmission Network User* to make a capital contribution or prepayment for all or part of the cost of the new assets installed.

In the event that a capital contribution is required, any contribution made will be taken into account in the determination of *prescribed transmission service* prices applicable to that *Transmission Network User* by way of a proportionate reduction in the ORC of the asset(s) used for the allocation of *prescribed transmission service* charges or as negotiated between the parties.

In the event that a prepayment is required, any prepayment made will be taken into account in the determination of *prescribed transmission service* prices applicable to that *Transmission Network User* in a manner to be negotiated between the parties.

The treatment of such capital contributions or prepayments for the purposes of a *revenue determination* will, in all cases, be in accordance with the relevant provisions of the *Rules*.

8 Prudent discounts

TasNetworks may, but is not required to, agree with a *Transmission Customer* to charge lower prices for the non-locational component of *prescribed TUOS services* and *prescribed common transmission services* provided to that *Transmission Customer*, than the prices determined in accordance with this *pricing methodology*.

In the event that TasNetworks agrees to charge a *Transmission Customer* a reduced charge, , TasNetworks may, in accordance with and subject to clauses 6A.26.1(d)-(f) of the *Rules*, update the *adjusted non-locational* component of *prescribed TUOS services* and/or the *prescribed common transmission services* prices and charges to *Transmission Customers* to recover the proportion of the discount amount that it is entitled to recover.

Where TasNetworks does not recover the proportion of the discount amount that it was entitled to recover from other *Transmission Customers* in the financial year in which the charges were reduced, TasNetworks may, in accordance with and subject to clause 6A.26.1(g) of the *Rules*, recover the outstanding amount through charges to *Transmission Customers* for the *adjusted non-locational component of prescribed TUOS services* in a subsequent financial year.

9 Inter-regional transmission charging

As noted in section 5.2, TasNetworks is the only *TNSP* in the Tasmanian region, which means that TasNetworks will calculate, bill and arrange for the payment of the *modified load export charge (MLEC)* in accordance with clause 6A.29A of the *Rules* and section 2.6 of the *Pricing Methodology Guidelines*.

As required by clause 6A.29A.3 of the *Rules*, TasNetworks will also calculate adjustments to the *MLEC* in accordance with clause 6A.23.3 of the *Rules*. For more details on *inter-regional transmission* charging refer to Appendix F of this *pricing methodology*.

10 Monitoring and compliance

As a regulated business, TasNetworks is required to maintain extensive compliance monitoring and reporting systems to ensure compliance with its Transmission Licence, *revenue determination*, the *Rules* together with numerous other legislative obligations.

In order to monitor and maintain records of its compliance with its approved *pricing methodology*, the *Pricing Principles for Prescribed Transmission Services*, and Part J of Chapter 6A of the *Rules*, TasNetworks will:

- maintain the specific obligations arising from Part J of Chapter 6A of the *Rules* in its compliance management system;
- maintain electronic records of the annual calculation of *prescribed transmission service* prices and supporting information; and
- periodically subject its *transmission* pricing models and processes to functional audit by suitably qualified persons.

11 New connections requiring significant investment

11.1 Impact on TUOS locational prices in cases of significant investment

If a new transmission network connection point requires significant investment in the network, TasNetworks may determine the TUOS locational price for the first year in accordance with section 11.2, to ensure customers who do not directly benefit from the investment are not directly or materially affected, for example, by an inequitable increase in the locational price and charges.

11.2 Setting TUOS locational prices in the first year of significant investment

In the event that a significant investment occurs, TasNetworks may determine the locational TUOS price(s) for the new transmission network connection point(s) using cost reflective network pricing and not apply the 2 per cent side constraint at the new connection point(s) relative to the load weighted average TUOS locational price for the region, as described in section 5.5.5.2.

12 Additional information requirements

A number of additional information requirements arise from the *Pricing Methodology Guidelines* which have not been covered elsewhere in this *pricing methodology*. In order to satisfy these requirements TasNetworks notes that it does not:

- consider transitional arrangements are necessary as a result of the implementation of the *pricing methodology*;
- have any applicable relevant derogations in accordance with chapter 9 of the *Rules*;
or
- have any applicable transitional arrangements arising from chapter 11 of the *Rules*.

TasNetworks has not provided a confidential version of this *pricing methodology* to the AER in accordance with section 2.5 of the *Pricing Methodology Guidelines* and hence the provisions of section 2.1(n) of the *Pricing Methodology Guidelines* are not applicable.

13 Conclusion

TasNetworks' *pricing methodology* for the *regulatory control period* from 1 July 2024 to 30 June 2029 has been submitted to the AER in accordance with the requirements of chapter 6A of the *Rules* and the *Pricing Methodology Guidelines*.

This *pricing methodology* incorporates new Rule requirements, minor changes, and additional context when compared to the *pricing methodology* that was approved by the AER for the 2019-2024 *regulatory control period*.

Appendix A: Overview of pricing process

Figure 1 Overview of pricing process³²

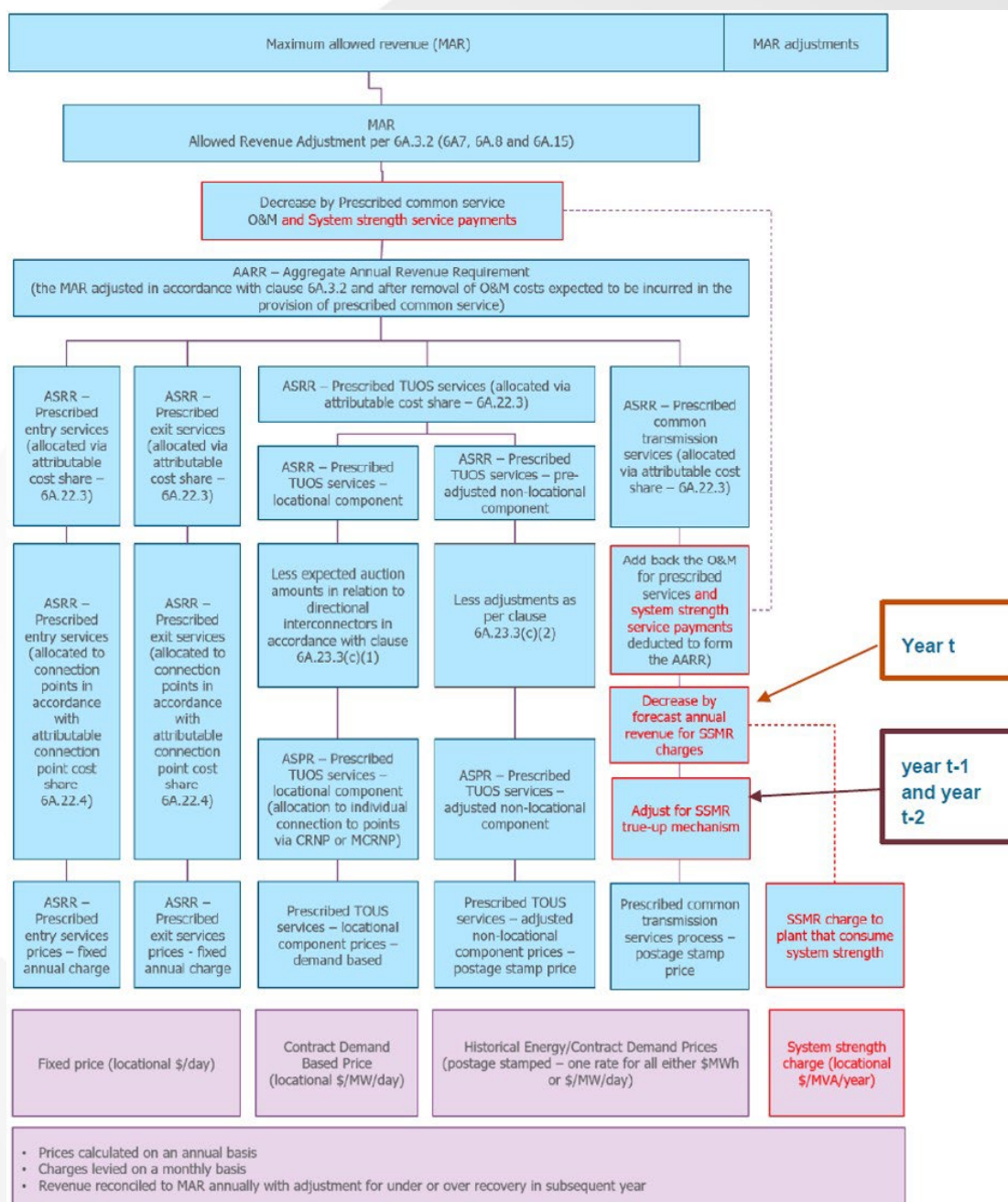

Note that the arrangements for system strength charging are marked up. SSMR refers to the system strength mitigation requirement as per the AEMC's Rule determination³³.

³² AER, Explanatory statement, Final decision - Pricing methodology guidelines: System strength pricing, 25 August 2022, page 31

³³ AEMC, Efficient Management of System Strength on the Power System Rule 2021, October 2021

Appendix B: Details of cost allocation process

A cost allocation process is used to assign the optimised replacement cost (ORC)³⁴ of all *prescribed transmission service* assets to each *category of prescribed transmission services* in a manner consistent with section 2.4 of the *Pricing Methodology Guidelines*.

The cost allocation process is summarised as follows:

Step 1: Initial cost allocation

Assets and their ORCs are assigned to one of the following primary asset categories:

- *transmission lines*;
- *transformers*;
- circuit breakers;
- common service assets (such as communications, reactive support, office buildings.); and
- *substation* local assets (ancillary equipment, civil work, and establishment).

The following plant items are not separately identified in the ORC database and are incorporated into the ORC of the associated primary items above:

- bus work.

Step 2: Allocation to categories of transmission services

Assets are allocated to the *categories of prescribed transmission services* in accordance with the provisions of section 2.4 of the *Pricing Methodology Guidelines*. In the case of a shared *connection* asset, such as a *transformer*, serving multiple *connection points* which may provide both *prescribed entry services* and *prescribed exit services*, the cost of the shared *connection* asset will be allocated to the appropriate *category or categories of prescribed transmission services* using an appropriate cost allocator. For example:

- *Generation or reactive plant* nameplate rating capacity or agreed maximum demand (AMD) supplied by the specified *transmission category of prescribed transmission services* as a percentage of the total capacity and *demand* of all *categories of prescribed transmission services* at that location: costs are attributable based on the capacity and/or AMD agreed upon by the customer(s);
- unit of *plant* method: costs are allocated based on the number of units of *plant* installed (typically circuit breakers) where these units of plant can be attributed to a particular *category of prescribed transmission service*; or
- as negotiated between the connecting parties.

This process would also be adopted to allocate shared costs to individual *connection points*.

³⁴ TasNetworks uses the optimised replacement cost of its assets sourced from its financial accounts. If these values are not available, TasNetworks will maintain an optimised replacement model of the *transmission network* to determine the appropriate optimised replacement cost of assets.

Step 3: Priority ordering

In the case of those costs which would be attributable to more than one *category of prescribed transmission services*, costs will be allocated in accordance with the provisions of clause 6A.23.2(d) of the *Rules*, having regard to the *stand-alone amount* costs associated with the provision of *prescribed TUOS services* and *prescribed common transmission services*, with the remainder being allocated to *prescribed entry services* and/or *prescribed exit services*. The implementation of the priority ordering process is detailed in Appendix D.

Conclusion

The shared *network* costs resulting from the cost allocation process are used as input to TPRICE, the *cost reflective network pricing* software that is approved by the AER for use by TNSPs in the NEM.

The entry cost, exit cost and common service costs are used as input to the calculation of *prescribed entry services prices*, *prescribed exit services prices* and *prescribed common transmission services prices*.

Appendix C: Cost reflective network pricing methodology

The *cost reflective network pricing methodology (CRNP methodology)* involves the following steps:

- determining the costs of the individual *transmission network* assets in the optimised *transmission network*;
- determining the proportion of each individual *network element* utilised in providing a *transmission service* to each point in the *network* for specified operating conditions;
- determining the maximum flow imposed on each *transmission element* by *load* at each *connection point*;
- allocating the costs attributed to the individual *transmission elements* to *loads* based on the proportionate use of the elements; and
- determining the total cost (lump sum) allocated to each point by adding the share of the costs of each individual *network element* attributed to each point in the *network*.

To avoid doubt, the optimised replacement cost of transmission system assets that are designated network assets and identified user shared assets is zero (clauses S6A.3.2(1) and S6A.3.3(1)).

Allocation of generation to load

A major assumption in the use of the *CRNP methodology* is the definition of the *generation* source and the point where *load* is taken. The approach is to use the “electrical distance” to pair *generation* to *load*, in which a greater proportion of *load* at a particular location is supplied by *Generators* that are electrically closer than those that are electrically remote. In electrical engineering terminology the “electrical distance” is the impedance between the two locations, and this can readily be determined through a standard engineering calculation called the “fault level calculation”.

Once the assumption has been made as to the *Generators* that are supplying each *load* for a particular *load* and *generation* condition (time of *day*) it is possible to trace the flow through the *network* that results from supplying each *load* (or *Generator*). The use made of any element by a particular *load* is the ratio of the flow on the element resulting from the supply to this *load* to the total use of the *load* made by all *loads* and *Generators* in the *power system*.

Operating conditions for cost allocation

The choice of operating conditions is important in developing prices using the *CRNP methodology* or *modified CRNP methodology*. TasNetworks has flexibility in the choice of operating conditions but notes that the *Rules* previously set out the principles that applied in determining the sample of operating conditions considered. Of particular note was the requirement that the operating conditions to be used were to include at least 10 *days* with highest system *demand*, to ensure that loading conditions, which impose peak flows on all *transmission elements*, were captured.

Clause S6A.3.2(3) of the *Rules* is less prescriptive, requiring that the allocation of dispatched *generation* to *loads* be over a range of actual operating conditions from the previous *financial year* and that the range of operating scenarios is chosen so as to include the conditions that result in most stress on the *transmission network* and for which *network* investment may be contemplated.

In selecting those operating scenarios it is important to recognise that the operating conditions that impose most stress on particular elements may occur at times other than for system peak *demand*. To avoid doubt, the individual locational *network* asset cost of a *network* asset that is a *designated network asset* or *identified user shared asset* is zero (schedule 6A.3.2(4)).

Load and generation data

Section 2.2(a) of the *Pricing Methodology Guidelines* requires that prices for the recovery of the locational component of *prescribed TUOS services* are based on demand at times of greatest utilisation of the *transmission network* and for which *network* investment is most likely to be contemplated, in accordance with clause 6A.23.4(b)(1) of the *Rules*.

The use made of the *network* by particular *loads* and *generators* will vary considerably depending on the *load* and *generation* conditions on the *network*. For this reason TasNetworks uses the full year of operating data (that is, either 365 or 366 days of half hourly data) as an appropriate set of operating conditions. The TPRICE capacity method of cost allocation (used by TasNetworks) automatically captures the *peak loading* conditions on *network elements* from the sample of operating conditions analysed.

Consistent with section 2.2(f) of the *Pricing Methodology Guidelines*, where actual operating conditions from the previous complete *financial year* are unavailable for a *connection point*, as would be the case for a new *connection point*, an estimate based on the *contract agreed maximum demand* and other characteristics of the *load* would be used to allocate costs to that *connection point*.

Appendix D: Priority ordering methodology

Rules requirements

Clause 6A.23.2(d) of the *Rules* requires that:

“Where, as a result of the application of the *attributable cost share*, a portion of the *AARR* would be attributable to more than one *category of prescribed transmission services*, that *attributable cost share* is to be adjusted and applied such that any costs of a *transmission system asset* that would otherwise be attributed to the provision of more than one *category of prescribed transmission services*, is allocated as follows:

- (1) to the provision of *prescribed TUOS services*, but only to the extent of the *stand-alone amount* for that *category of prescribed transmission services*;
- (2) if any portion of the costs of a *transmission system asset* is not allocated to *prescribed TUOS services*, under subparagraph (1), that portion is to be allocated to *prescribed common transmission services*, but only to the extent of the *stand-alone amount* for that *category of prescribed transmission services*; and
- (3) if any portion of the costs of a *transmission system asset* is not attributed to *prescribed transmission services* under subparagraphs (1) and (2), that portion is to be attributed to *prescribed entry services* and *prescribed exit services*.”

Stand-alone amount is defined as:

“For a category of *prescribed transmission services*, the costs of a *transmission system asset* that would have been incurred had that *transmission system asset* been developed, exclusively to provide that *category of prescribed transmission services*.”

Clause 11.6.11(c) of the *Rules* states the following:

“For the purposes of new Chapter 6A:

- (1) the costs of the *transmission system assets* that from time to time may be treated as:
 - (i) directly attributable to the provision of a *prescribed connection service*; or
 - (ii) incurred in providing a *prescribed connection service*,

to a *Transmission Network User* or a group of *Transmission Network Users* at a *transmission network connection point* is limited to the costs of the eligible assets which, from time to time, provide that *prescribed connection service*;

- (2) any costs of an existing asset or a replacement asset (or of any portion of an existing asset or a replacement asset) that:
 - (i) is not an eligible asset (other than as a result of clause 11.6.11(d)); and
 - (ii) is used by a *Transmission Network Service Provider* to provide *connection services* to a *Transmission Network User* or a group of *Transmission Network Users* at a *transmission network connection point*,

must be treated as costs that are directly attributable to the provision of, or are incurred in providing, *prescribed TUOS services* and, to avoid doubt, the services provided by those assets which would otherwise be *connection services* are taken to be *prescribed TUOS services*; and

- (3) the *stand-alone amount* for *prescribed TUOS services* is taken to include any portion of the costs referred to in clause 11.6.11(c)(2) that has not been allocated under clause 6A.23.2(d)(1)."

This provision effectively introduces a fourth step to the priority ordering requirement.

Objective and general approach

The allocation methodology relies on the assumption that *substation* infrastructure and establishment costs are proportionate to the number of *high-voltage* circuit breakers in the *substation*.

Based on this assumption, the appropriate allocator for *substation* infrastructure and establishment costs for a stand-alone arrangement is the ratio of the number of *high voltage* circuit breakers³⁵ in the stand-alone arrangement to the number of *high voltage* circuit breakers in the whole *substation*.

Proposed methodology

As illustrated by the diagrams below, a "branch" is a collection of assets (for example, *transmission lines*, circuit breakers, capacitors, buses and *transformers*) that provide a *transmission service*.

Figure 2 Branch with transmission line, bus and circuit breaker

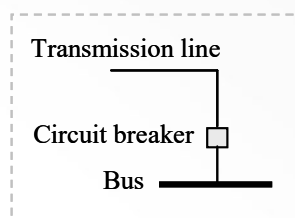
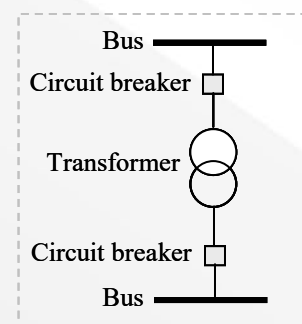
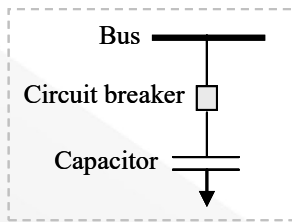

Figure 3 Branch with transformer, circuit breaker and two busses



³⁵ Low voltage circuit breakers are not considered in the stand-alone arrangements.

Figure 4 Branch with capacitor, circuit breaker and bus



Step 1: Branch identification

Identify the branches – being the *transmission lines*, *transformers*, major reactive devices and exits/entries in the *substation* which provide *prescribed TUOS services*, *prescribed common transmission services* and *prescribed entry services* or *prescribed exit services* – in the *substation*.

Step 2: Allocation of circuit breakers to branches

For each *high voltage* circuit breaker in the *substation*, identify the branches directly connected to it. Any circuit breaker that does not directly connect to a branch is excluded from allocation and all costs associated with it are added to the *substation* infrastructure and establishment cost.

Count the total number of circuit breakers directly connected to branches.

As a general rule, branches connecting *Distribution Network Service Providers (DNSPs)* are classified as *prescribed exit services* while branches connecting *generators* are classified as *prescribed entry service*. Assets providing *negotiated services* are not part of the regulatory asset base and fall outside the priority ordering process detailed in clause 6A.23.2(d) of the *Rules*.

Step 3: Determination of stand-alone arrangements

Step 3.1: Stand-alone arrangements for prescribed TUOS services

With reference to the number of *transmission lines* providing *prescribed TUOS services*, determine the number of circuit breakers required to provide TUOS services of an equivalent standard on a stand-alone basis. TasNetworks understands the stand-alone configuration should be the simplest *substation* configuration (in the absence of development) had the *substation* been developed to provide only *prescribed TUOS services*. This may be done by way of a look up of typical stand-alone configurations.

Step 3.2: Stand-alone arrangements for prescribed common transmission services

With reference to the number of *transmission lines* providing *prescribed TUOS services* and devices providing *prescribed common transmission services*, determine the number of circuit breakers required to provide *prescribed common transmission services* of an equivalent standard on a stand-alone basis.³⁶ TasNetworks understands the stand-alone configuration to

³⁶ The number of *transmission lines* providing *prescribed TUOS services* is included in determining the number of circuit breakers required to provide *prescribed common transmission services* on a stand-alone basis because the *prescribed common transmission services* are provided to the entire *transmission network*, so they cannot be considered in isolation but must be connected to the *transmission network* through the *prescribed TUOS services*.

be the simplest *substation* configuration (in the absence of development) had the *substation* been developed to provide only *prescribed common transmission services*. This may be done by way of a look up of typical stand-alone configurations.

Step 4: Allocation of substation infrastructure and establishment costs

Step 4.1 Allocation to prescribed TUOS services

Allocate a portion of the *substation* infrastructure and establishment costs to *prescribed TUOS services* according to the ratio of the *high voltage* circuit breakers identified in step 3.1 to the total number of *high voltage* circuit breakers connected to branches in the *substation* identified in step 2.

Step 4.2 Calculate the unallocated substation infrastructure costs after TUOS allocation

Calculate the unallocated *substation* infrastructure cost by subtracting the amount calculated in step 4.1 from the total *substation* infrastructure amount. If the unallocated *substation* infrastructure cost is zero (that is, the *prescribed TUOS services* component of the *substation* infrastructure costs equals the total *substation* infrastructure amount), then no *substation* infrastructure costs would be allocated to *prescribed common transmission services*, *prescribed entry services* or *prescribed exit services*.

Step 4.3 Allocation to prescribed common transmission services

Allocate a portion of the *substation* infrastructure and establishment costs to *prescribed common transmission services* based on to the ratio of the *high voltage* circuit breakers providing *prescribed common transmission services* identified in step 3.2 to the total number of *high voltage* circuit breakers connected to branches in the *substation*. If the common service portion of *substation* infrastructure is greater than the unallocated costs calculated in step 4.2, then only the unallocated portion is attributed to *prescribed common transmission service*. In this instance, no *substation* infrastructure costs would be allocated to *prescribed entry services* or *prescribed exit services*.

Step 4.4 Calculate the unallocated substation infrastructure costs after common service allocation

Re-calculate the unallocated *substation* infrastructure cost by subtracting the amount calculated in step 4.3 from the amount calculated in step 4.2. If the unallocated *substation* infrastructure cost is zero (that is, the *prescribed TUOS services* and *prescribed common transmission services* components of the *substation* infrastructure costs equals the total *substation* infrastructure amount), then no *substation* infrastructure costs would be allocated to *prescribed entry services* or *prescribed exit services*.

Step 4.5 Allocation of remaining costs

If any of the *substation* infrastructure and establishment costs have been allocated to *prescribed TUOS services* or *prescribed common transmission services* under steps 4.1 and 4.3 above, allocate the remaining costs (calculated in step 4.4) to *prescribed TUOS services*.³⁷ However, if none of the costs have been allocated to *prescribed TUOS services* or *prescribed common transmission services* under steps 4.1 or 4.3, allocate the remaining *substation* infrastructure and establishment costs (calculated in step 4.4) to each branch providing

³⁷ See clause 11.6.11(c) of the *Rules*.

prescribed entry services or *prescribed exit services*. This allocation will be based on the ratio of the *high voltage* circuit breakers providing the *prescribed entry services* or *prescribed exit services* to the total number of *high voltage* circuit breakers, or in accordance with TasNetworks' Cost Allocation Methodology as appropriate.³⁸

Notes on process

The following points should be noted:

- costs are only allocated in step 4 until fully allocated;
- consistent with clause 6A.23.2(d)(3) of the *Rules*, it is possible that no costs will be attributed to *prescribed entry services* or *prescribed exit services*;
- new and existing *negotiated service* assets are excluded from the analysis as any incremental establishment costs associated with such assets are taken to be included in the *negotiated services* charges on a causation basis; and
- the assessment of stand-alone arrangements only needs to be conducted once per *substation* except where changes to the configuration of the *substation* occur.

³⁸ The allocation between (or within) *prescribed entry services* or *prescribed exit services* is not included in the priority ordering process as it was not considered in clause 6A.23.3(d)(3) of the *Rules*.

Appendix E: Examples of application of priority ordering process

Example A

Figure 5 Substation configuration: example A

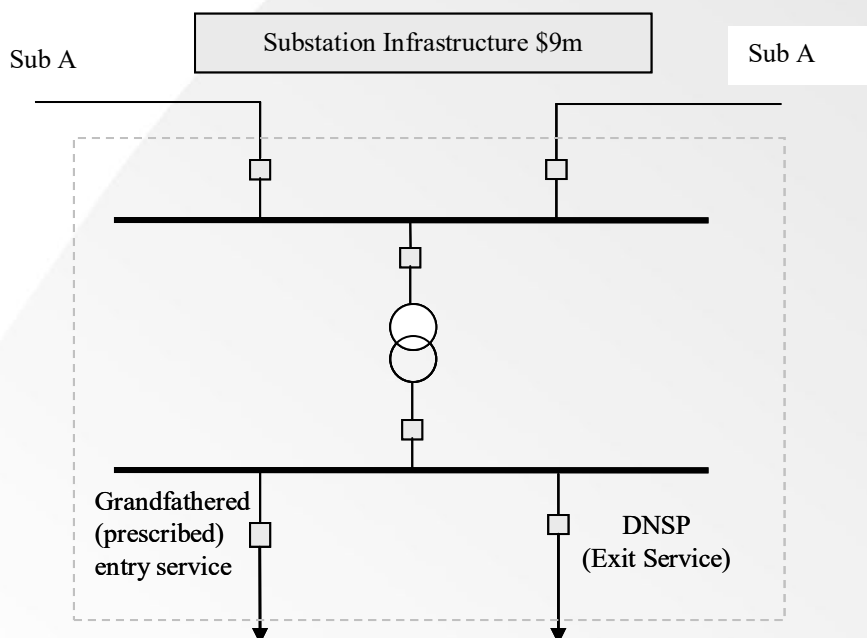

Step 1: The branches are two *transmission lines* to Sub A, a *prescribed exit service* to a DNSP, and a *prescribed entry service* to a Generator that is grandfathered under clause 11.6.11 of the Rules.³⁹

Step 2: The total number of circuit breakers directly connected to branches is 6.

Step 3.1: No *prescribed TUOS services* are provided at this site.

Step 3.2: No *prescribed common transmission services* are provided at this site.

Step 4: Assume the total infrastructure cost that can be allocated to more than one *category of prescribed transmission service* is \$9 million.

³⁹ With the exception of Example A, these examples do not include reference to any *prescribed entry services* for two reasons (i) for the sake of simplicity and (ii) because the impact of a *prescribed entry service* is the same as for a *prescribed exit service*. Therefore, references in the examples to *prescribed exit service* are interchangeable with references to *prescribed entry services*. This interchangeability between *prescribed entry services* and *prescribed exit service* for the purpose of cost allocation under priority ordering is the reason that the table in each example includes reference to “Costs to entry and exit” even though the relevant example may only include *prescribed exit services*. Furthermore, in a situation where there is more than one *prescribed entry services* and/or *prescribed exit service*, such as those shown in Examples A or E, the allocation of costs between the *prescribed entry services* and/or *prescribed exit service* is described in step 3 of Appendix B.

Step 4.1: Costs are allocated to *prescribed TUOS services* in the ratio of the number of circuit breakers in the stand-alone arrangement to the total number of circuit breakers. Therefore, the infrastructure cost allocated to TUOS = $(0/6) \times \$9\text{m} = \0m

Step 4.2: Unallocated = $\$9\text{m} - \$0\text{m} = \$9\text{m}$

Step 4.3: Costs are allocated to *prescribed common transmission service* in the ratio of the number of circuit breakers in the stand-alone arrangement to the total number of circuit breakers. Therefore, the infrastructure cost allocated to common service = $(0/6) \times \$9\text{m} = \0m

Step 4.4: Unallocated = $\$9\text{m} - \$0\text{m} = \$9\text{m}$

Step 4.5: As none of the infrastructure cost has been allocated in the preceding steps, the remaining (unallocated) cost is allocated to *prescribed entry services* and *prescribed exit services*. Therefore, the infrastructure cost allocated to *prescribed entry services* and *prescribed exit services* = $\$9\text{m}$

Table 8 Priority ordering allocation: example A

	Number	Allocated (\$)	Yet to be allocated (\$)
Substation infrastructure costs			9,000,000
Total breakers	6		
TUOS stand-alone breakers	0		
Costs to TUOS	0	0	9,000,000
Common service stand-alone breakers	0		
Costs to common service	0	0	9,000,000
Costs to entry and exit		9,000,000	0
TOTAL		9,000,000	0

Table 9 Summary of cost allocation: example A

	Allocated (\$)
Costs allocated to TUOS	0
Costs allocated to common service	0
Costs allocated to entry and exit	9,000,000
TOTAL	9,000,000

Example B

Figure 6 Substation configuration: example B

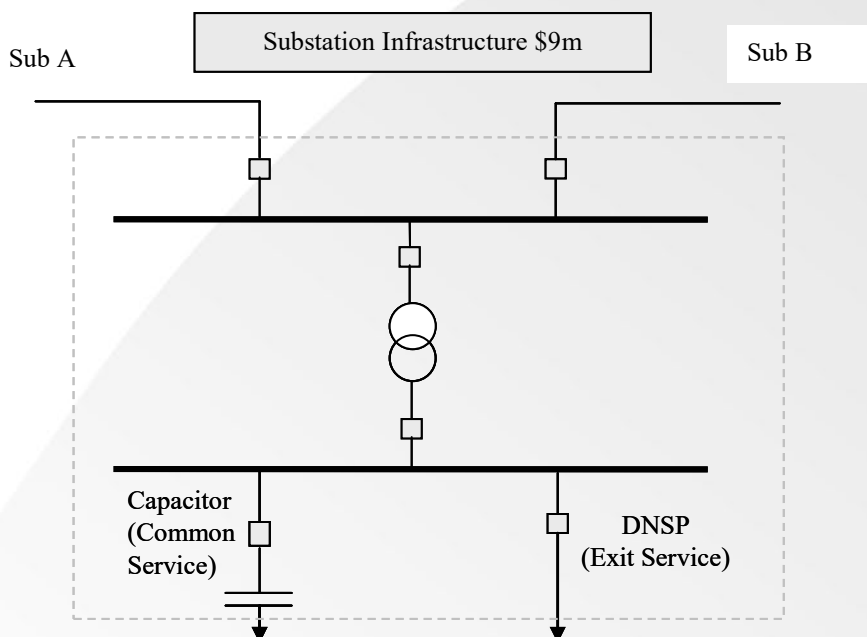

Step 1: The branches are *transmission lines* to Sub A and Sub B, a *prescribed exit service* to a DNSP, a *transformer* and a *capacitor*.

Step 2: The total number of circuit breakers directly connected to branches is 6.

Step 3.1: The stand-alone arrangement for the provision of *prescribed TUOS services* to an equivalent standard is shown below and consists of 2 circuit breakers.

Figure 7 Stand-alone prescribed TUOS services: example B

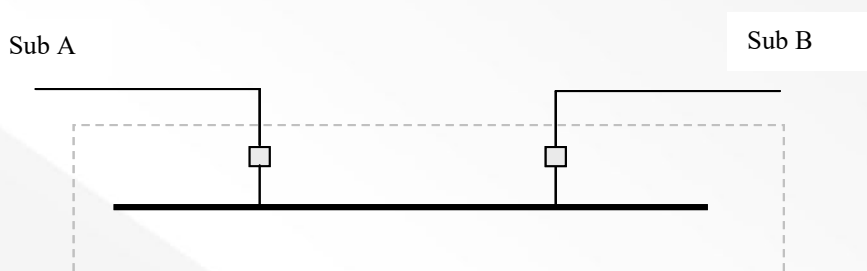

Step 3.2: The stand-alone arrangement for the provision of *prescribed common transmission services* to an equivalent standard is shown below and consists of 3 circuit breakers.

Figure 8 Stand-alone prescribed common transmission services: example B

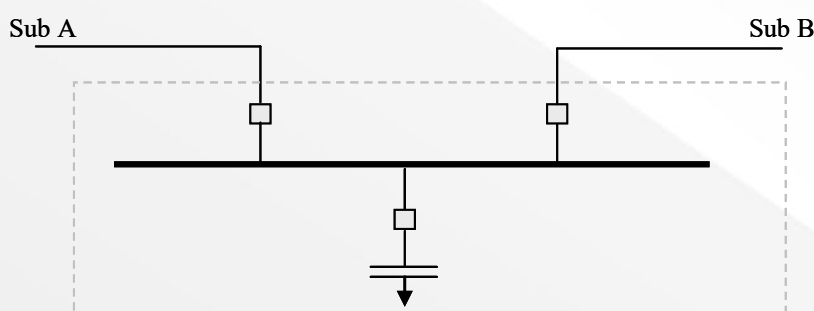

Step 4: Assume the total infrastructure cost that can be allocated to more than one *category of prescribed transmission service* is \$9 million.

Step 4.1: Costs are allocated to *prescribed TUOS services* in the ratio of the number of circuit breakers in the stand-alone arrangement to the total number of circuit breakers. Therefore, the infrastructure cost allocated to TUOS = $(2/6) \times \$9\text{m} = \3m

Step 4.2: Unallocated = $\$9\text{m} - \$3\text{m} = \$6\text{m}$

Step 4.3: Costs are allocated to *prescribed common transmission service* in the ratio of the number of circuit breakers in the stand-alone arrangement to the total number of circuit breakers. Therefore, the infrastructure cost allocated to common service = $(3/6) \times \$9\text{m} = \4.5m

Step 4.4: Unallocated = $\$6\text{m} - \$4.5\text{m} = \$1.5\text{m}$

Step 4.5: As part of the infrastructure cost has been allocated in the preceding steps, the remaining (unallocated) cost is allocated to *prescribed TUOS services*. Therefore, the total infrastructure cost allocated to *prescribed TUOS services* = $\$1.5\text{m} + \$3\text{m} = \$4.5\text{m}$

Table 10 Priority ordering allocation: example B

	Number	Allocated (\$)	Yet to be allocated (\$)
Substation infrastructure costs			9,000,000
Total breakers	6		
TUOS stand-alone breakers	2		
Costs to TUOS	0.333	3,000,000	6,000,000
Common service stand-alone breakers	3		
Costs to common service	0.500	4,500,000	1,500,000
Costs to TUOS		1,500,000	0
TOTAL		9,000,000	0

Table 11 Summary of cost allocation: example B

	Allocated (\$)
Costs allocated to TUOS	4,500,000
Costs allocated to common service	4,500,000
Costs allocated to entry and exit	0
TOTAL	9,000,000

Example C

Figure 9 Substation configuration: example C

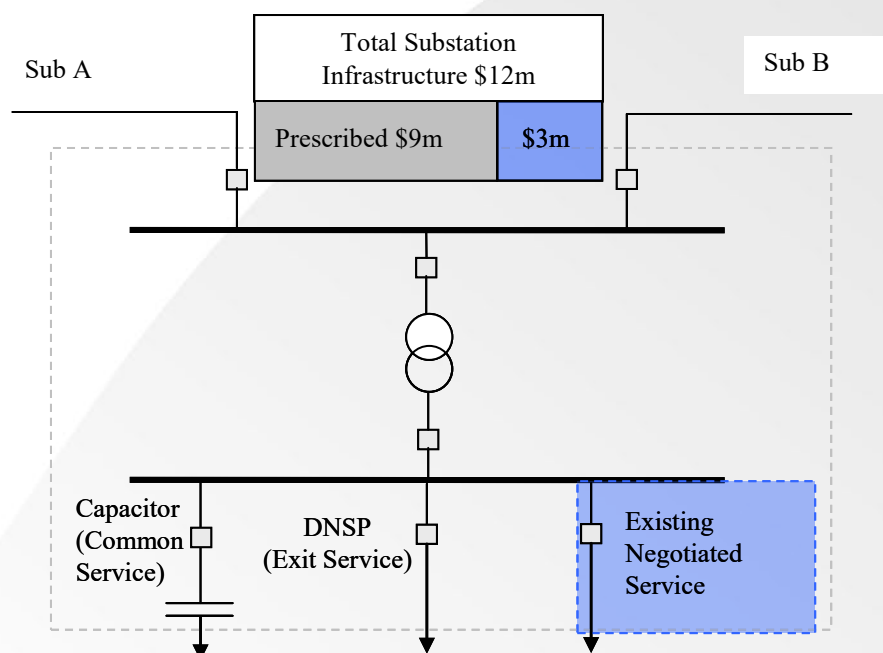

Step 1: The branches are *transmission lines* to Sub A and Sub B, a *prescribed exit service* to a DNSP, a *transformer*, a *capacitor* and an *existing negotiated service*.

Step 2: The total number of circuit breakers directly connected to branches is 6 (none of the costs for *prescribed transmission services* are allocated to the *negotiated service*).

Step 3.1: The stand-alone arrangement for the provision of *prescribed TUOS services* to an equivalent standard is shown below and consists of 2 circuit breakers.

Figure 10 Stand-alone prescribed TUOS services: example C

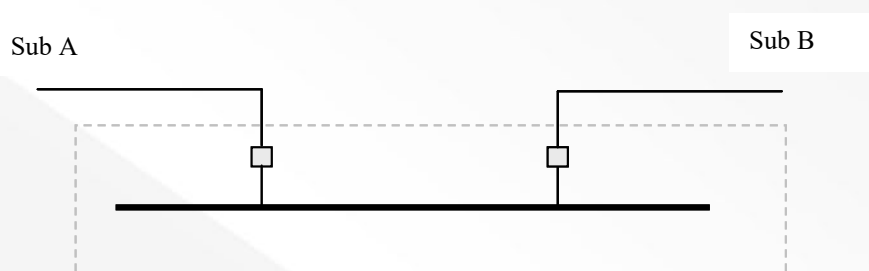

Step 3.2: The stand-alone arrangement for the provision of *prescribed common transmission services* to an equivalent standard is shown below and consists of 3 circuit breakers.

Figure 11 Stand-alone prescribed common transmission services: example C

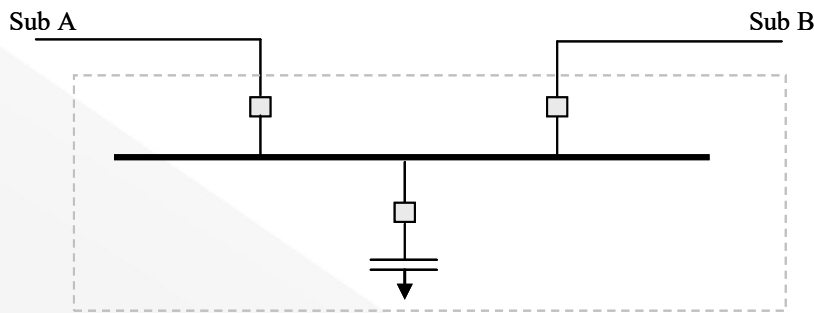

Step 4: Assume the total infrastructure cost is \$12m; \$3m of which is for the existing *negotiated service*, which does not form part of the regulatory asset base and is not governed by clause 6A.23.2(d) of the *Rules*. Therefore, the total infrastructure cost that can be allocated to more than one *category of prescribed transmission service* is \$9 million.

Step 4.1: Costs are allocated to *prescribed TUOS services* in the ratio of the number of circuit breakers in the stand-alone arrangement to the total number of circuit breakers. Therefore, the infrastructure cost allocated to TUOS = $(2/6) \times \$9\text{m} = \3m

Step 4.2: Unallocated = $\$9\text{m} - \$3\text{m} = \$6\text{m}$

Step 4.3: Costs are allocated to *prescribed common transmission service* in the ratio of the number of circuit breakers in the stand-alone arrangement to the total number of circuit breakers. Therefore, the infrastructure cost allocated to common service = $(3/6) \times \$9\text{m} = \4.5m

Step 4.4: Unallocated = $\$6\text{m} - \$4.5\text{m} = \$1.5\text{m}$

Step 4.5: As part of the infrastructure cost has been allocated in the preceding steps, the remaining (unallocated) cost is allocated to *prescribed TUOS services*. Therefore, the infrastructure cost allocated to prescribed TUOS services = $\$1.5\text{m} + \$3\text{m} = \$4.5\text{m}$

Table 12 Priority ordering allocation: example C

	Number	Allocated (\$)	Yet to be allocated (\$)
Substation infrastructure costs			9,000,000
Total breakers	6		
TUOS stand-alone breakers	2		
Costs to TUOS	0.333	3,000,000	6,000,000
Common service stand-alone breakers	3		
Costs to common service	0.500	4,500,000	1,500,000
Costs to TUOS		1,500,000	0
TOTAL		9,000,000	0

Table 13 Summary of cost allocation: example C

	Allocated (\$)
Costs allocated to TUOS	4,500,000

	Allocated (\$)
Costs allocated to common service	4,500,000
Costs allocated to entry and exit	0
TOTAL	9,000,000

Example D

Figure 12 Substation configuration: example D

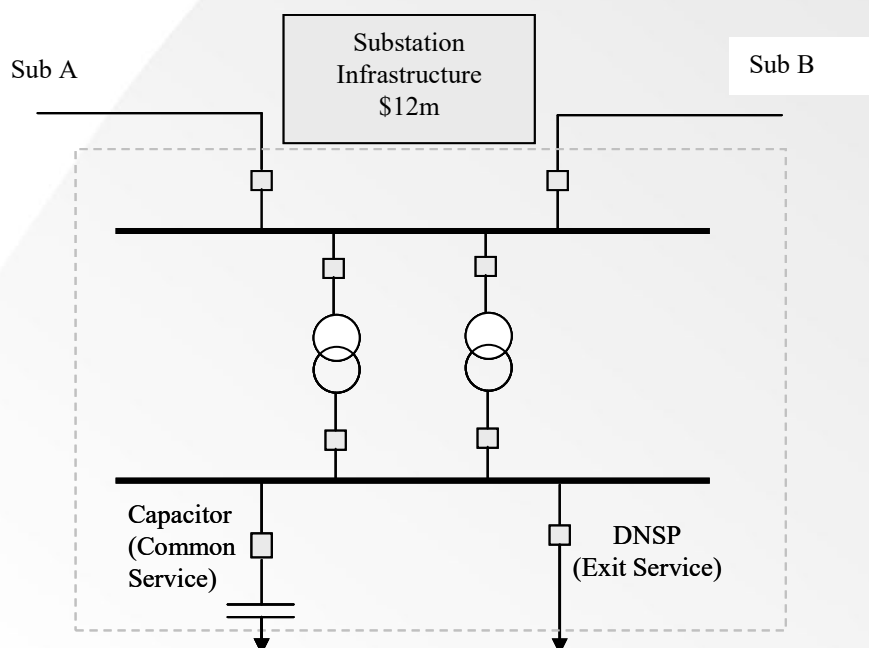

Step 1: The branches are *transmission lines* to Sub A and Sub B, a *prescribed exit service* to a DNSP, two *transformers* and a *capacitor*.

Step 2: The total number of circuit breakers directly connected to branches is 8.

Step 3.1: The stand-alone arrangement for the provision of *prescribed TUOS services* to an equivalent standard is shown below and consists of 2 circuit breakers.

Figure 13 Stand-alone prescribed TUOS services: example D

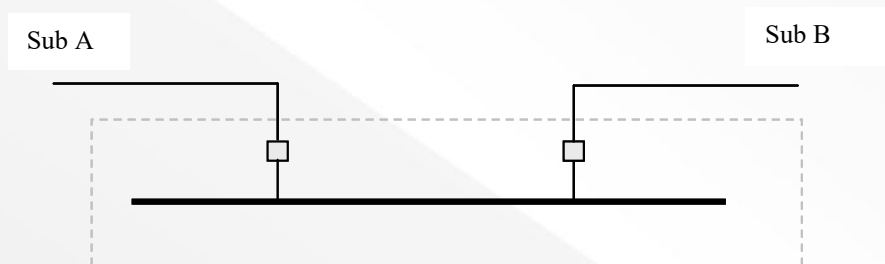

Step 3.2: The stand-alone arrangement for the provision of *prescribed common transmission services* to an equivalent standard is shown below and consists of 3 circuit breakers.

Figure 14 Stand-alone prescribed common transmission services: example D

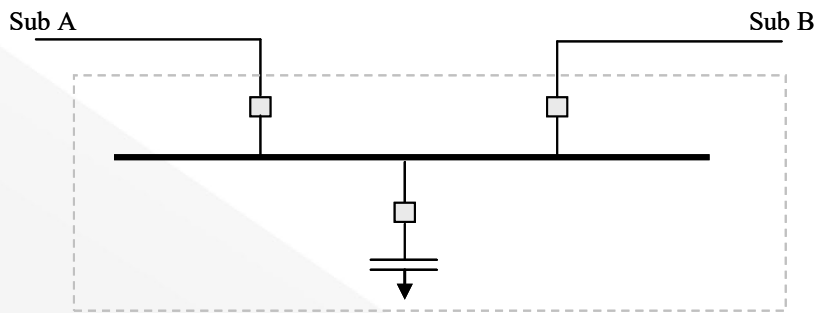

Step 4: Assume the total infrastructure cost that can be allocated to more than one *category of prescribed transmission service* is \$12 million.

Step 4.1: Costs are allocated to *prescribed TUOS services* in the ratio of the number of circuit breakers in the stand-alone arrangement to the total number of circuit breakers. Therefore, the infrastructure cost allocated to TUOS = $(2/8) \times \$12\text{m} = \3m

Step 4.2: Unallocated = $\$12\text{m} - \$3\text{m} = \$9\text{m}$

Step 4.3: Costs are allocated to *prescribed common transmission service* in the ratio of the number of circuit breakers in the stand-alone arrangement to the total number of circuit breakers. Therefore, the infrastructure cost allocated to common service = $(3/8) \times \$12\text{m} = \4.5m

Step 4.4: Unallocated = $\$9\text{m} - \$4.5\text{m} = \$4.5\text{m}$

Step 4.5: As part of the infrastructure cost has been allocated in the preceding steps, the remaining (unallocated) cost is allocated to *prescribed TUOS services*. Therefore, the infrastructure cost allocated to *prescribed TUOS services* = $\$4.5\text{m} + \$3\text{m} = \$7.5\text{m}$

Table 14 Priority ordering allocation: example D

	Number	Allocated (\$)	Yet to be allocated (\$)
Substation infrastructure costs			12,000,000
Total breakers	8		
TUOS stand-alone breakers	2		
Costs to TUOS	0.250	3,000,000	9,000,000
Common service stand-alone breakers	3		
Costs to common service	0.375	4,500,000	4,500,000
Costs to TUOS		4,500,000	0
TOTAL		12,000,000	0

Table 15 Summary of cost allocation: example D

	Allocated (\$)
Costs allocated to TUOS	7,500,000

	Allocated (\$)
Costs allocated to common service	4,500,000
Costs allocated to entry and exit	0
TOTAL	12,000,000

Example E

Figure 15 Substation configuration: example E

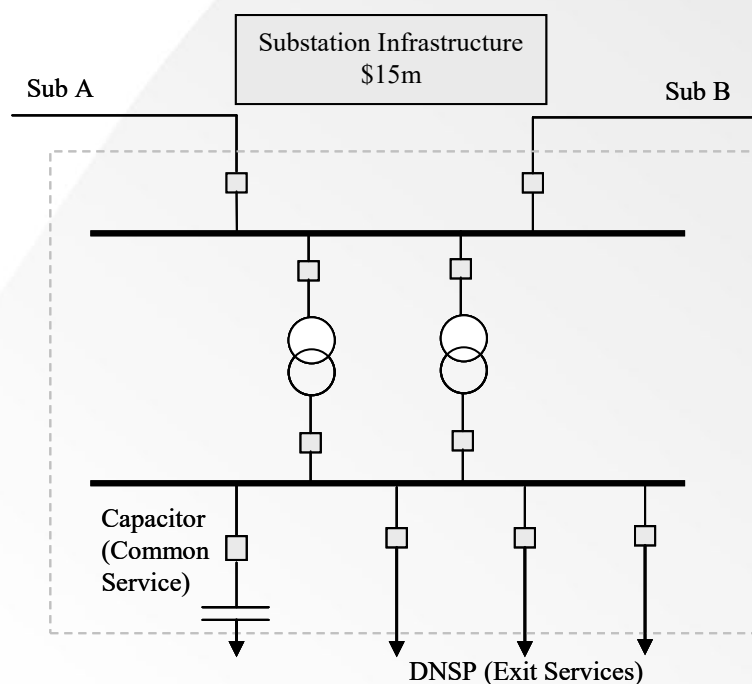

Step 1: The branches are *transmission lines* to Sub A and Sub B, *prescribed exit services* to DNSP(s), two *transformers* and a *capacitor*.

Step 2: The total number of circuit breakers directly connected to branches is 10.

Step 3.1: The stand-alone arrangement for the provision of *prescribed TUOS services* to an equivalent standard is shown below and consists of 2 circuit breakers.

Figure 16 Stand-alone prescribed TUOS services: example E

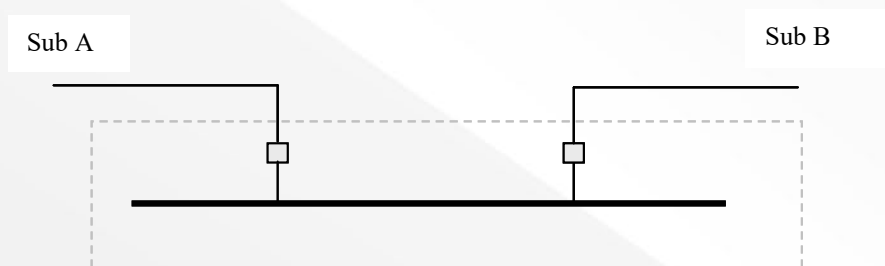

Step 3.2: The stand-alone arrangement for the provision of *prescribed common transmission services* to an equivalent standard is shown below and consists of 3 circuit breakers.

Figure 17 Stand-alone prescribed common transmission services: example E

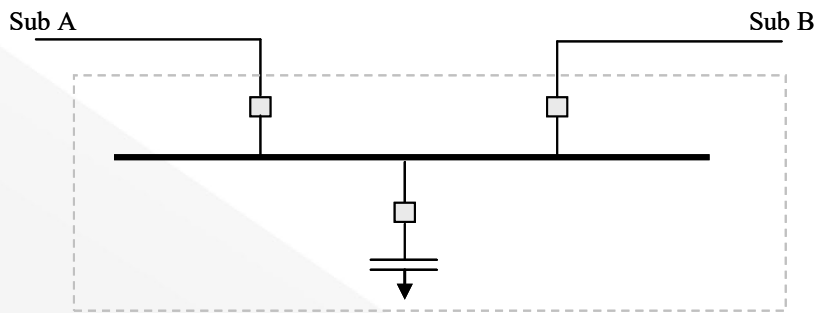

Step 4: Assume the total infrastructure cost that can be allocated to more than one *category of prescribed transmission service* is \$15 million.

Step 4.1: Costs are allocated to *prescribed TUOS services* in the ratio of the number of circuit breakers in the stand-alone arrangement to the total number of circuit breakers. Therefore, the infrastructure cost allocated to TUOS = $(2/10) \times \$15\text{m} = \3m

Step 4.2: Unallocated = $\$15\text{m} - \$3\text{m} = \$12\text{m}$

Step 4.3: Costs are allocated to *prescribed common transmission service* in the ratio of the number of circuit breakers in the stand-alone arrangement to the total number of circuit breakers. Therefore, the infrastructure cost allocated to common service = $(3/10) \times \$15\text{m} = \4.5m

Step 4.4: Unallocated = $\$12\text{m} - \$4.5\text{m} = \$7.5\text{m}$

Step 4.5: As part of the infrastructure cost has been allocated in the preceding steps, the remaining (unallocated) cost is allocated to *prescribed TUOS services*. Therefore, the infrastructure cost allocated to *prescribed TUOS services* = $\$7.5\text{m} + \$3\text{m} = \$10.5\text{m}$

Table 16 Priority ordering allocation: example E

	Number	Allocated (\$)	Yet to be allocated (\$)
Substation infrastructure costs			15,000,000
Total breakers	10		
TUOS stand-alone breakers	2		
Costs to TUOS	0.200	3,000,000	12,000,000
Common service stand-alone breakers	3		
Costs to common service	0.300	4,500,000	7,500,000
Costs to TUOS		7,500,000	0
TOTAL		15,000,000	0

Table 17 Summary of cost allocation: example E

	Allocated (\$)
Costs allocated to TUOS	10,500,000
Costs allocated to common service	4,500,000
Costs allocated to entry and exit	0
TOTAL	15,000,000

Appendix F: Inter-regional transmission charging

Introduction

The *inter-regional transmission* charging arrangement allows *TNSPs* to levy a *MLEC* on *TNSPs* in neighbouring *regions*. *Transmission* load customers would subsequently pay a share of the costs of *transmission* used to import electricity into their *region* from neighbouring *regions*.

TasNetworks is currently the only *Transmission Network Service Provider (TNSP)* in the Tasmanian *region*, which means that TasNetworks will calculate, bill and arrange for the payment of the *modified load export charge (MLEC)* in accordance with clause 6A.29A of the *Rules* and section 2.6 of the *AER's Pricing Methodology Guidelines*. TasNetworks will also undertake this function if it is to be appointed the *CNSP* for the Tasmanian region with other *TNSP(s)* operating in the Tasmanian region.

TasNetworks will publish details of all *MLECs* to apply in the following *financial year* on its website by 15 February each year consistent with clause 6A.24.2(b) of the *Rules*.

Overview of the process

An overview of the process to calculate the *MLEC* is shown in Figure 18.

The steps involved to calculate the *MLEC* are:

Step 1:

The *AARR* will be calculated as described in section 5.3 of this *pricing methodology*.

The allocation of the *AARR* to each of the *categories of prescribed transmission services* will be calculated as described in section 5.5.2 of this *pricing methodology*. This will determine the *ASRR* to be recovered from *prescribed TUOS services*.

The calculations in Step 1 are the same as for calculating *transmission* prices.

Step 2:

As required by clause 6A.29A.2(a)(1) of the *Rules*, the *MLEC* is to be calculated from 50 per cent of the *ASRR* for *prescribed TUOS services*.

Step 3:

The amount determined in Step 2 is the *TUOS* revenue to be recovered on a locational basis and is adjusted in accordance with clause 6A.29A.2(a)(2) of the *Rules* by:

- subtracting estimated *inter-regional settlements residue* auction proceeds (which are nil for Tasmania);
- subtracting a portion of the *settlements residue* as referred to in clause 6A.23.3(b)(1) of the *Rules* (which is also nil for Tasmania); and
- including any adjustments as required by clause 6A.29A.3 of the *Rules*.

Figure 18 Overview of process to calculate the MLEC

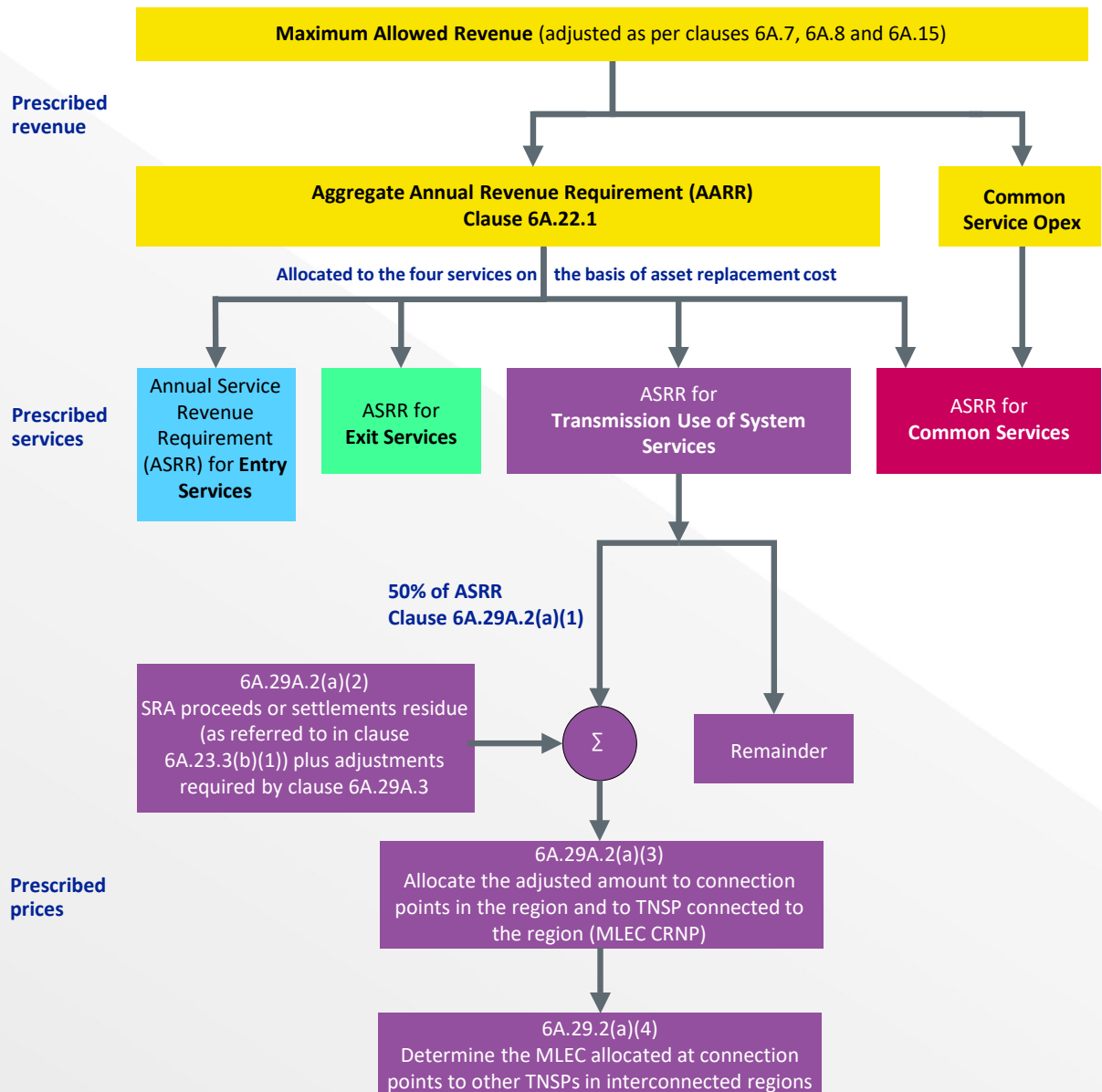
**Step 4:**

Clause 6A.29A.2(a)(3) of the *Rules* requires the adjusted amount from Step 3 to be allocated to *connection points of transmission customers* in the Tasmanian *region* and to *CNSPs interconnected* to the Tasmanian *region* as if they were *connected as transmission customers*. This allocation will be made on a proportionate use of *transmission system* assets. Consistent with the requirements of clause 6A.29A.2(a)(3) of the *Rules*, TasNetworks will only use the *MLEC CRNP methodology* for estimating the proportionate use of the relevant *transmission system* assets.

TasNetworks applies the *CRNP methodology* using the TPRICE *cost reflective network pricing* software used by all *TNSPs* in the *NEM*.

The *CRNP methodology* requires three sets of input data:

- an electrical (load flow) model of the *network*;

- a cost model of the *network*; and
- a set of *load/ generation* patterns.

Appendix C of this *pricing methodology* describes the *CRNP methodology* in more detail.

The key requirements for *MLEC CRNP methodology* are:

- *MLEC* is to be determined using standard *CRNP* approach;
- all *transmission elements* are to be included;
- all half hour periods in the previous full *financial year* are to be used; and
- peak usage of assets must be used.

For each *regulatory year* TasNetworks will calculate the *MLEC* using the *MLEC CRNP methodology*. The calculation will use *generation* and *load* data from the previous *financial year* completed at the time the *MLEC CRNP* is being calculated.

Step 5:

Clause 6A.29A.2(a)(4) of the *Rules* requires the *MLEC* to be recovered from *CNSPs* in *interconnected regions* to be the amount allocated to *connection points* to neighbouring *regions* as determined in Step 4.

Timetable for the provision of data

Should TasNetworks become an *CNSP*, each *TNSP* located in the Tasmanian region is required to provide the *CNSP* with all information reasonably required for the calculation of the *MLEC* estimate (clause 6A.29A.4(e)).

To facilitate this information transfer, Section 2.6 of the *pricing methodology guidelines* requires a *CNSP* to specify a timetable for the provision of all necessary data for the calculation of the *inter-regional* and *intra-regional transmission* charges.

The following timetable for the provision of data will facilitate the calculation of the *MLEC* to apply in the Tasmanian region by 15 February each year. It should be noted that customers must provide notification of annual demand adjustments by 1 February each year, even if the customer's *Transmission Connection Agreement* specifies a later date. This notification requirement arises from the *Distribution Network Pricing Arrangements Rule* (27 November 2014), which brought forward the dates of publication of *inter-regional* and *intra-regional transmission* prices.

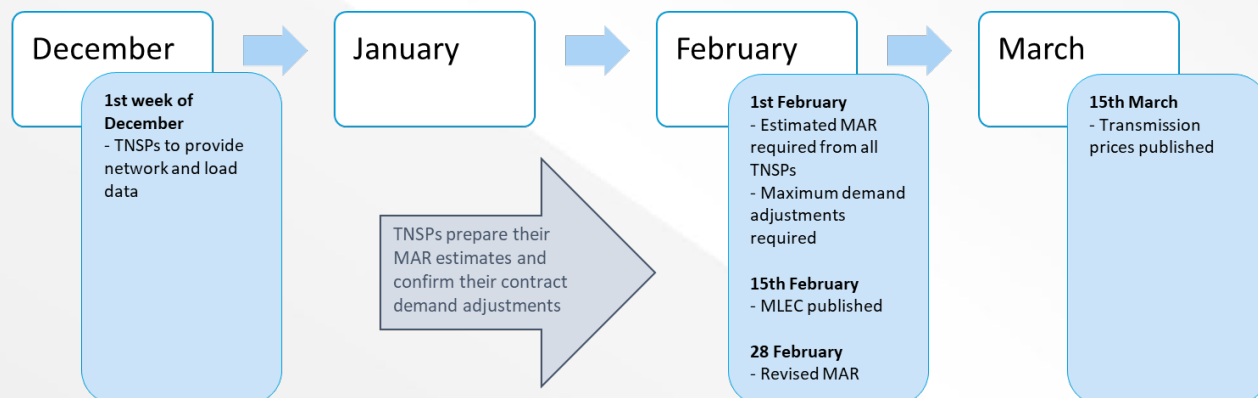

Billing the modified load export charge

TasNetworks will issue a monthly bill to *AEMO* (as the *CNSP* in the only *interconnected region*) for the *MLEC* amount payable to TasNetworks in accordance with clause 6A.29A.4(a) of the *Rules*. The monthly bills will include any adjustments made in accordance with clause 6A.29A.3 of the *Rules*.

In accordance with clause 6A.29A.4(b) of the *Rules*, the monthly bill will include:

- the total annual estimate of *MLEC* payable by the *CNSP*;
- details of the *MLEC CRNP* allocation and the adjustments as specified in clauses 6A.29A.3 and 6A.23.3(f) of the *Rules*; and
- the monthly instalment amount.

Billing arrangements between multiple TNSPs in a region

Allocation of amounts to each TNSP in the same region

Where there is more than one TNSP in a *region*, and if TasNetworks becomes a *CNSP*, the *CNSP* is required to allocate any amounts receivable by or payable to it for *MLEC* to each TNSP in accordance with its *pricing methodology* (clause 6A.29A.5(a)).

If TasNetworks becomes a *CNSP*, TasNetworks will allocate any amounts receivable or payable for *MLEC* to each relevant TNSP in the Tasmanian *region* for the following *financial year* as required by clause 6A.29A.5 of the *Rules*.

This allocation will be based on the *MLEC CRNP methodology* for estimating the proportionate use of the relevant *transmission system* assets. The allocation of amounts will be calculated according to *intra-regional*, rather than *inter-regional*, *network* utilisation.

For the avoidance of doubt, these amounts will be incorporated in the *connection point* prices determined by TasNetworks for each TNSP in the Tasmanian *region*. TasNetworks will collect all the regulated revenue entitlements via TasNetworks *prescribed transmission service prices*.

Billing each TNSP in the same region

Clause 6A.29A.5(b) of the *Rules* requires the *CNSP* to issue bills for the net amounts (allocated in clause 6A.29A.5(a)) receivable by or payable to the *CNSP* for *MLEC* to each TNSP in its *region*.

TasNetworks will issue a bill to each TNSP in the Tasmanian *region* for the net amount of *MLEC* as required in clause 6A.29A.5(b) of the *Rules* to be paid in equal monthly instalments or as documented in revenue collection agreements negotiated between the parties. Such payments will be calculated by TasNetworks. TasNetworks will also provide reasonable details on the calculation of these amounts.

Worked example – Modified Load Export Charge

The example uses the same figures referred to in the examples of this *pricing methodology*.

Step 1 – Aggregate annual revenue requirement (AARR)

In accordance with clause 6A.22.1 of the *Rules*, the *maximum allowed revenue* is adjusted:

- (a) in accordance with clause 6A.3.2 of the *Rules*, and
- (b) by subtracting the operating and maintenance costs expected to be incurred in the provision of *prescribed common transmission services* and expected *system strength service payments*; and
- (c) by any allocation as agreed between *Transmission Network Service Providers* in accordance with clause 6A.29.3 of the *Rules*.

This example assumes that the *maximum allowed revenue* is \$152,000,000.

Table 18 Derivation of AARR to be allocated to the four services

Derivation	Amount
Maximum allowed revenue	152,000,000
Total adjustments for: <ul style="list-style-type: none"> • network support pass through; • cost pass through; • payments under the service target performance incentive scheme; and • contingent projects 	+5,000,000
Deduct operating and maintenance expenditure (incurred in the provision of prescribed common services) and expected <i>system strength service payments</i>	-7,000,000
AARR to be allocated	150,000,000

Step 2 – Annual service revenue requirement

Similar to the calculation example in section 5.5.2 of this *pricing methodology*, the *ASRR* for each *category of prescribed transmission service* is calculated as shown in Table 19.

Table 19 Asset allocations to service categories

Category	Asset value (\$)	Cost share
Exit service	100,000,000	0.10
Entry service	50,000,000	0.05
TUOS service	650,000,000	0.65
Common service	200,000,000	0.20
Total	1,000,000,000	1.00

The cost share percentages shown in Table 19 are used to allocate the revenue to be recovered from each *category of prescribed transmission service*. In accordance with the adjustments set out in Table 18, Table 20 shows that the revenue to be allocated (the *AARR*) is \$150,000,000.

Table 20 Calculation of Annual Service Revenue Requirements (ASRR)

Category	Cost share	ASRR to be recovered from each service (\$)
Exit service	0.10	15,000,000
Entry service	0.05	7,500,000
TUOS service	0.65	97,500,000

Category	Cost share	ASRR to be recovered from each service (\$)
Common service	0.20	30,000,000
Total	1.00	150,000,000

Clause 6A.29A.2(a)(1) of the *Rules* then requires 50 per cent of the ASRR for *prescribed TUOS services* to be calculated:

Table 21 Calculation of Annual Service Revenue Requirements (ASRR) for MLEC

Category	Asset value (\$)
50% of TUOS service	48,750,000

Step 3 – Adjustment for settlement residue auction proceeds

For this example, the *settlement residue* auction proceeds and other adjustments are assumed to be zero.

Step 4 – Standard CRNP Calculation

An electrical model of the Tasmanian *transmission network* is set-up including all *transmission elements*. The TPRICE software is used to calculate the allocation of costs based on a proportionate use of *transmission system* assets.

For the Tasmanian *transmission network*, TPRICE is used to determine the cost allocation for each *connection point* to another *region*.

Table 22 Standard CRNP allocation and interconnector cost share

Connection Point	CRNP ORC allocation	Cost share
Interconnector 1	65,000,000	0.065
Interconnector 2	135,000,000	0.135
Total for interconnector connection points	200,000,000	0.20
TasNetworks	800,000,000	0.80
Total for all connection points	1,000,000,000	1.00

Step 5 – Modified load export charge to be recovered

The revenue to be recovered is pro-rated using the adjusted ASRR from Step 2.

Table 23 Modified load export charge

Connection Point	Cost share	Revenue to be recovered from each connection point (\$)
Interconnector 1	0.065	3,168,750
Interconnector 2	0.135	6,581,250
MLEC for the Victorian region	0.20	9,750,000

Worked example – allocation and billing to other TNSPs in Tasmania

The allocation of net MLEC to each TNSP in the Tasmanian region is based on the CRNP cost allocations to connection points (Table 22). This allocation net of MLEC requires a CNSP to issue a bill to each TNSP within the region of the net MLEC payable or receivable (clause 6A.29A.5(b)). In actual fact, the net MLEC amount is already included in the calculated prices for each TNSP, so there is no net MLEC amount to be transferred to or from the CNSP. This calculation is solely for information purposes and to satisfy rule 6A.29A.5.

The net MLEC amount allocated to each TNSP is then obtained by pro-rating the total MLEC amounts by the CRNP allocation as shown in Table 24. The below is a hypothetical of potential impacts on the attributed MLEC to each TNSP in the Tasmanian Region.

Table 24 Calculation of MLEC attributed to each TNSP in the Tasmanian region

TNSPs in Tasmania	Net MLEC for the Victorian Region (\$)	Cost share
Interconnector 1	633,750	0.065
Interconnector 2	1,316,250	0.135
TasNetworks	7,800,000	0.80
MLEC for the Victorian region	9,750,000	1.00

Appendix G: System strength charges

The AER's explanatory statement explained that⁴⁰:

- A *system strength service provider's* proposed methodology for setting the *System Strength Unit Price* (SSUP) must be based on the long run average cost (LRAC) of providing *system strength transmission services* at each *system strength node*;
- *System strength service providers* must use a period of at least 10 years when forecasting long run costs; and
- If the unit price is updated for indexation each year, the basis for indexation must be consistent with the approach for inflation indexation of the transmission network's maximum allowed revenue under its revenue determination.

As explained in this *pricing methodology*, our proposed approach to setting the SSUP complies with these requirements.

The purpose of this Appendix G is to provide illustrative numerical examples to show how the pricing methodology may apply in the following cases:

- Case 1: LRAC set for 10 year period, using a combination of network and non-network solutions; and
- Case 2: As per Case 1, with SSUP reset for years 6-15 with existing network solutions no longer reflecting the forward-looking costs.

In both cases, the SSUP calculates the LRAC over a 10 year period. The examples illustrate how the SSUP may change depending on whether the actual costs of the network solution are higher or lower than the forward-looking costs.

It should be noted that while the focus is on network solutions in these examples, the same approach may apply to non-network solutions where 'locked in' contracts for non-network services no longer reflect the forward-looking costs of providing *system strength services*.

⁴⁰ AER, Explanatory statement, Final decision - Pricing methodology guidelines: System strength pricing, 25 August 2022, page 5.

Case 1 LRAC set based on 10 year forecasts, using combination of network and non-network solutions (All dollar amounts are stated in real terms)

	Year	1	2	3	4	5	6	7	8	9	10	Total
Row 1	Total System Strength requirement (MVA)	1000	1000	1200	1200	1500	1500	1600	1600	1800	1800	14200
Row 2	Requirement met by network solutions (MVA)	500	500	500	500	1000	1000	1000	1000	1000	1000	
Row 3	Annual unit cost of network solutions (\$/MVA)	\$7,400	\$7,400	\$7,400	\$7,400	\$7,400	\$7,400	\$7,400	\$7,400	\$7,400	\$7,400	
Row 4	Annual total cost of network solutions (\$M)	\$3.7	\$3.7	\$3.7	\$3.7	\$7.4	\$7.4	\$7.4	\$7.4	\$7.4	\$7.4	\$59.2
Row 5	Requirement met by non-network solutions (MVA)	500	500	700	700	500	500	600	600	800	800	
Row 6	Annual unit cost of non-network solutions (\$/MVA)	\$8,400	\$8,200	\$8,286	\$8,214	\$8,000	\$7,900	\$7,833	\$7,667	\$7,625	\$7,500	
Row 7	Annual total cost of non-network solutions (\$M)	\$4.2	\$4.1	\$5.8	\$5.8	\$4.0	\$4.0	\$4.7	\$4.6	\$6.1	\$6.0	\$49.2
Row 8	Total annual cost of meeting requirement (\$M)	\$7.9	\$7.8	\$9.5	\$9.5	\$11.4	\$11.4	\$12.1	\$12.0	\$13.5	\$13.4	\$108.4

SSUP is the 10-year LRAC, which is \$7,634 per MVA
 This price applies for years 1-5 and will be revisited for year 6 onwards

Row 1 shows the total system strength requirement in MVA for each year, as specified by *AEMO*. To simplify the exposition, this example assumes that the total system strength requirement at the node is the same as the total system strength hosting capacity (SSQ x SSL) at each of the connection points served by that node. In practice, however, the sum of the total system strength hosting capacity at the connection points may exceed the total system strength requirement at the node.

In this example, the TNSP has determined that the most economic mix of resources that will meet the requirement consists of a combination of network and non-network solutions. Row 2 shows the total system strength requirement that will be met by network solutions for each year. This information is provided to illustrate the implied \$/MVA cost for the network and non-network solutions, noting that the *System Strength Service Provider* will plan to meet the system strength standard at the lowest total life cycle cost.

Row 3 shows the real annual cost per MVA of the network solutions for each year. The annual cost will reflect the expected economic life of the network solution.

Row 4 shows the total annual cost (in real terms) of the network solutions. It is calculated by multiplying the values in Row 2 (MVA provided by network solutions) and Row 3 (real annual cost of network solutions per MVA) for each year.

Row 5 shows the total system strength requirement in MVA to be met by non-network solutions. In each year, the amount of *system strength service* provided by non-network solutions is the difference between the total requirement and the amount provide by the network solutions.

Row 6 shows the forecast real cost of non-network solutions per unit of MVA provided in each year.

Row 7 shows the total annual cost (in real dollars) of the non-network solutions. It is calculated by multiplying the values in Row 5 (MVA provided by non-network solutions) and Row 6 (real annual cost of non-network solutions per MVA) for each year.

Row 8 shows the total annual cost of meeting the specified system strength requirement. It is calculated by summing the values in Row 4 and Row 7.

The long run average cost of meeting the specified system strength requirements is \$7,634 per MVA. It is calculated by summing the total annual cost over 10 years shown in Row 8 (\$108.4 million) and dividing that number by the sum of the total MVA of *system strength services* provided over the period (14,200 MVA, as shown in Row 1). As noted above, to simplify the exposition, it is assumed that the total system strength capacity is the same as the system strength hosting capacity provided at the node. In practice, the long run average cost would divide the total cost over 10 years by the total system strength hosting capacity.

The table below (Case 2) illustrates the pricing methodology at the first re-set at the end of year 5, where the forward-looking costs are lower than the actual network costs. The greyed out data does not feature in this SSUP calculation in this case.

Case 2 as per Case 1, with SSUP reset for years 6-15 with existing network solutions no longer reflecting the forward-looking costs (All dollar amounts are stated in real terms)

	Year	1-5 (as per case 1)	6	7	8	9	10	11	12	13	14	15	Total (years 6-15)
Row 1	Total System Strength requirement (MVA)		1500	1600	1600	1800	1800	1800	2000	2300	2300	2300	19000
Row 2	Requirement met by network solutions (MVA)		1000	1000	1000	1000	1000	1000	1000	1000	1000	1000	
Row 3	Annual unit cost of network solutions (\$/MVA)		\$7,400	\$7,400	\$7,400	\$7,400	\$7,400	\$7,400	\$7,400	\$7,400	\$7,400	\$7,400	
Row 4	Annual total cost of network solutions (\$M)		\$7.4	\$7.4	\$7.4	\$7.4	\$7.4	\$7.4	\$7.4	\$7.4	\$7.4	\$7.4	
Row 5	Forward-looking annual unit cost of network solutions (\$/MVA)		\$7,400	\$7,400	\$7,400	\$7,400	\$7,400	\$7,250	\$7,250	\$7,250	\$7,250	\$7,250	
Row 6	Forward-looking annual total cost of network solution (\$M)		\$7.4	\$7.4	\$7.4	\$7.4	\$7.4	\$7.3	\$7.3	\$7.3	\$7.3	\$7.3	\$73.3
Row 7	Requirement met by non-network solution (MVA)		500	600	600	800	800	800	1000	1300	1300	1300	
Row 8	Annual unit cost of non-network solution (\$/MVA)		\$7,900	\$7,833	\$7,667	\$7,625	\$7,500	\$7,300	\$7,200	\$7,000	\$6,750	\$6,700	
Row 9	Annual total cost of non-network solution (\$M)		\$4.0	\$4.7	\$4.6	\$6.1	\$6.0	\$5.8	\$7.2	\$9.1	\$8.8	\$8.7	\$65.0
Row 10	Total annual cost of meeting requirement (\$M)		\$11.4	\$12.1	\$12.0	\$13.5	\$13.4	\$13.1	\$14.5	\$16.4	\$16.0	\$16.0	\$138.2

As per case 1, the annual SSUP is set at \$7,634 per MVA for years 1-5 based on LRAC for years 1-10.

SSUP is reset in year 6 at \$7,275 per MVA based on the LRAC for years 6-15

In this example, at the end of year 5, the forecast costs of meeting the specified system strength requirements for the next 10 years are assessed. In this example, the costs of the network and non-network solutions for years 6 to 10 are unchanged from the initial assessment (shown in Case 1). Over years 11 to 15, the forecast unit costs of non-network solutions (shown in Row 8) are expected to fall.

It is estimated that the most cost-effective system strength resource that would be available to meet the remaining requirement (which will be met by network solutions) has a cost of \$7,250/MVA/year. Accordingly, the annual unit cost of the network solutions is adjusted down from \$7,400/MVA (Row 3) to \$7,250/MVA (Row 5). For the purpose of calculating the 10 year LRAC for years 6 to 15, the reduced forward-looking cost of the network solutions is adopted.⁴¹ Accordingly, the values in Rows 3 and 4 for years 11 to 15 are shaded grey and excluded from the calculations, while the values in Rows 5 and 6 are used in the calculations instead.

The long run average cost of meeting the specified system strength requirements over years 6 to 15 is \$7,275 per MVA. It is calculated as the sum of the total annual costs over the period from years 6 to 15 (Row 10, \$138.2 million) divided by the sum of the system strength requirements over the same period (Row 1, 19,000). This cost is lower than the \$7,634/MVA/year calculated for the initial 10 year period, reflecting:

- the forecast reduction in the unit cost of non-network solutions over years 11 to 15; and
- the reduction in the forward-looking cost of network solutions for years 11 to 15.

As noted in relation to case 1, the above exposition has been simplified by assuming that the total system strength hosting capacity is the same as the system strength capacity provided at the node.

⁴¹ Conversely, if the forward-looking annual costs were, say, \$8,000 per MVA, compared to TasNetworks' actual annual costs of \$7,400 per MVA, the lower costs would be adopted.